

APPLITEC

SWISS TOOLING

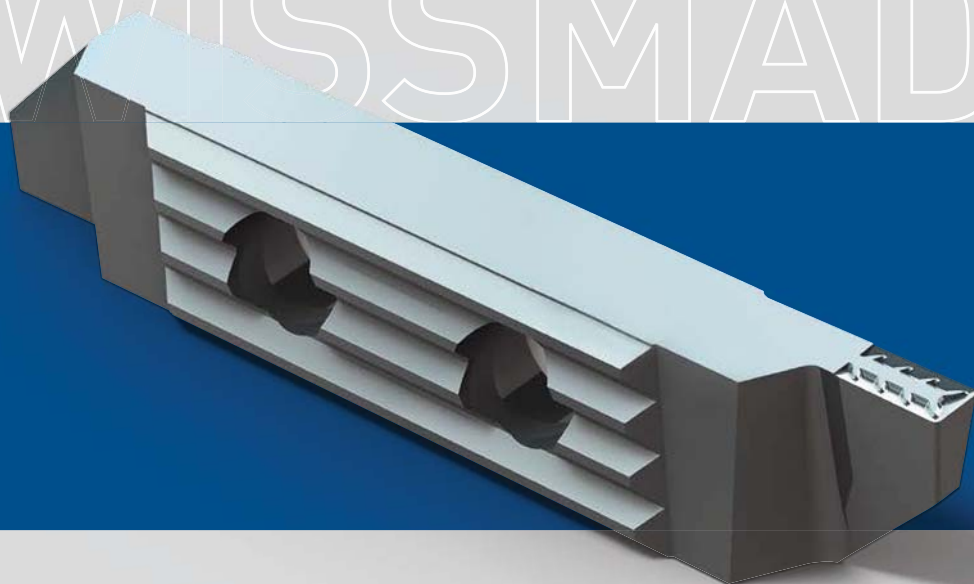

SWISSMADE



**OUTILS DE HAUTES PERFORMANCES
POUR LE DÉCOLLETAGE
ET LA MICROMÉCANIQUE**

**HOCHLEISTUNGSWERKZEUGE
FÜR DREHAUTOMATEN
UND MIKROMECHANIK**

**HIGH PERFORMANCE TOOLING
FOR AUTOMATIC LATHES
AND MICROMECHANICS**

	TOP-LINE	1
	TOP-WATCH	2
	PRO-LINE	3
	ECO-LINE	4
	TRIO-LINE	5
	TURN-LINE	6
	ISO-LINE	7
	EVOCUT-LINE	8
	CUT-LINE	9
	IN-LINE	10
	MODU-LINE	11
	TOOLING-LINE	12
	MICRO-LINE	13
	CIRCO-LINE	14
	INDEX	15

Nouveautés présentées dans ce catalogue
 Neuheiten dieses Kataloges
 New products introduced in this catalogue



APPLITEC

New references		
Type Typ Type	Ref.	Page Seite Page
731	731-0.6	1.32
	731X4-0.6	1.33
735	735X-90	1.62
736	736-55-1.5-R02	1.63
	736-55-2.0-R02	1.63
740	740-8-80-NOVIBRA	1.30
	740-0810-JET	1.27
741	741-0.6	1.32
	741X4-0.6	1.33
744	741X4-0.8	1.33
	744-1.5-R15	1.56
	744-2.0-R15	1.56
	744X-1.5-R15	1.56
745	744X-2.0-R15	1.56
	745X-90	1.62
746	746-55-1.5-R02	1.63
	746-55-2.0-R02	1.63
751	751RZU	1.96
754	754ZXT10-1.5-R20	1.122
	754ZXT10-2.0-R20	1.122
	754ZXT10-2.5-R20	1.122
756	756-55-2-R02	1.123
	756-55-3-R02	1.123
760	760/750-AX	1.77
761	761U-1.5	1.85
	761ZU	1.86
762	762VX-800	1.103
	762VUX	1.104
763	763VUX	1.114
764	764-1.5-R15	1.117
	764-2.0-R15	1.117
	764-2.5-R15	1.117
	764-3.0-R15	1.117
	764X-1.5-R15	1.119
	764X-1.8	1.119
	764X-2.0-R15	1.119
	764X-2.0-R35	1.119
	764X-2.5-R15	1.119
	764X-2.5-R35	1.119
	764X-3.0-R15	1.119
	764X-3.0-R35	1.119
	764X-4.0-R35	1.119

764	764X5-EP	1.120
	764X10-EP	1.121
	764ZXB	1.123
	764ZXT10-2.0-R40	1.124
	764ZXT10-2.5-R40	1.124
766	764ZXT10-4.0-R80	1.124
	766-55-2-R02	1.125
770	766-55-3-R02	1.125
	770-10	1.132
771	770-JET	1.133
	771RU	1.138
780	780-10	1.132
	780-JET	1.133
W751	W751-EP5	1.150
	W751-EP6	1.151
W761	W761-EP5	1.150
	W761-EP6	1.151
Polyg. interface	C3-760	1.152
	C4-750	1.153
HSK	HSK	1.154
Schütte	Schütte	1.164

New TiAlX		
Type Typ Type	TiAlX	Page Seite Page
741	741	1.32
	741X4	1.33
	741X12	1.35
	741X25	1.36
742	742	1.46
	742X	1.48
743	743	1.49
	743X	1.50
744	744	1.56
	744X	1.58
	744ZX10	1.59
	744ZXT	1.60
751	751R	1.88
	751R-R05	1.90
	751RS	1.89
761	761	1.78
	761-R05	1.80
	761S	1.79
762	762S05	1.106

763	763S05	1.106
	764	1.117
	764X	1.119
	764ZX	1.122
764	764X5-EP	1.120
	764X10-EP	1.121
	764ZXB	1.123
	764ZXT	1.124

New HTAX		
Type Typ Type	HTAX	Page Seite Page
744	744	1.56
	744X	1.58

New LOX		
Type Typ Type	Lox	Page Seite Page
744	744X	1.58
	744ZXT	1.60
764	764X	1.119
	764X5-EP	1.120
	764X10-EP	1.121
	764ZXB	1.123
	764ZXT	1.124

INFO

Nuances et paramètres de coupe
Sorten und Schnittwerte
Grades and machining data

> **1.02****710 / 720**

Pour machines à cames
Für kurvengesteuerte Maschinen
For cam driven machines

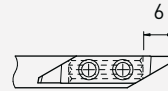
> **1.12****730 / 740**

Main series
Small type

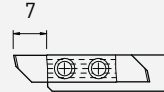
> **1.24****750 / 760**

Main series
Large type

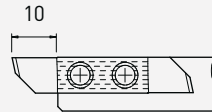
> **1.68**

770 / 780
7050 / 7060
W750 / W760
POLYGONAL INTERFACE
HSK
740Z / 760Z
TORNOS
SCHÜTTE

Tronçonnage de grande capacité et ébauches larges pour
profilage + porte-outils spéciaux

Abstechen für grössere Durchmesser und breite Rohlinge
für Profilschleifen + Sonderwerkzeughalter

High capacity parting off and wide blanks for profiling +
special tool holders

> **1.131**

Pièces de rechange
Ersatzteile
Spare parts

> **1.165**

TOP-LINE

Codification des plaquettes TOP-Line série 700

WSP-Bezeichnungssystem für TOP-Line 700 Serie

Inserts designation key for TOP-Line 700 series



Dimension
Abmessung
Dimension

Rayon
Radius
Radius

Nuance
Sorte
Grade

Géométrie de coupe / Brise-copeaux / Particularités
 Schneidgeometrie / Spanbrecher / Sondereigenschaften
 Cutting geometry / Chip breaker / Special features

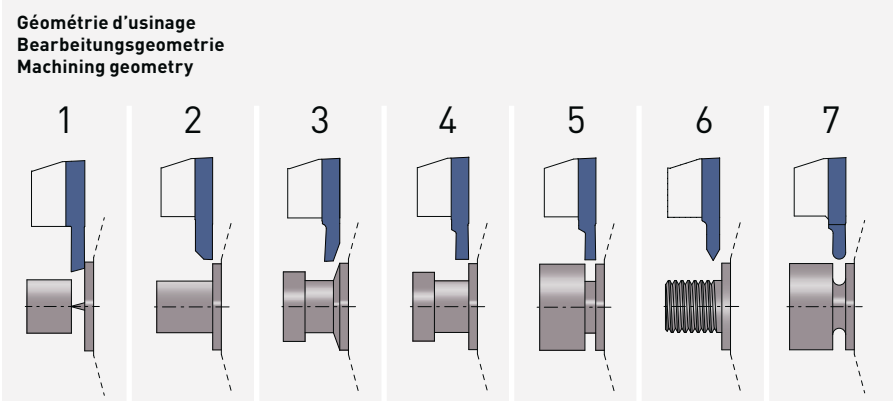

Gamme de produit
 Produktserie
 Product series

définit la compatibilité des plaquettes avec le porte-outil
 bestimmt die WSP und Halter Kompatibilität
 shows the inserts and holder compatibility

L = 1, 3, 5, 7 (chiffre impair / ungerade Zahl / uneven number)
 R = 2, 4, 6, 8 (chiffre pair / gerade Zahl / even number)

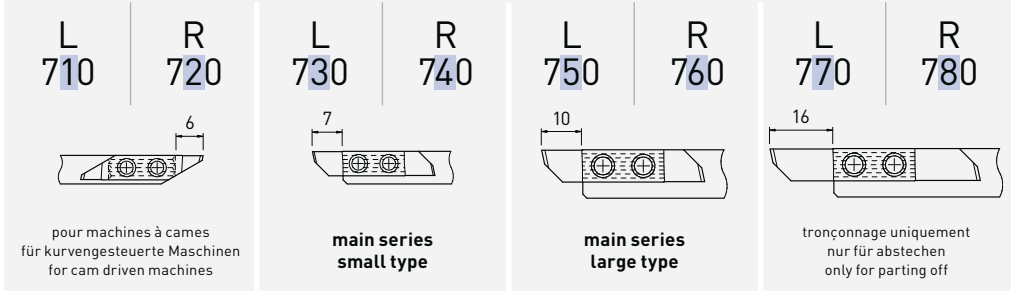

Applitec série 700
 Applitec 700 Serie
 Applitec 700 series

Système de serrage à denture décalée avec 2 vis de fixation
 Spannsystem mit 2 Schrauben und verschobener Verzahnung
 Shifted teeth clamping system with 2 screws

L'outil de référence pour le décolletage

Hochwertiges Wendeplattensystem für Langdrehautomaten

Top class turning tool for automatic lathes

700 Series

100% rigid!

Système de serrage Applitec à denture décalée
 Applitec-Spannsystem mit verschobener Verzahnung
 Applitec clamping system with shifted teeth

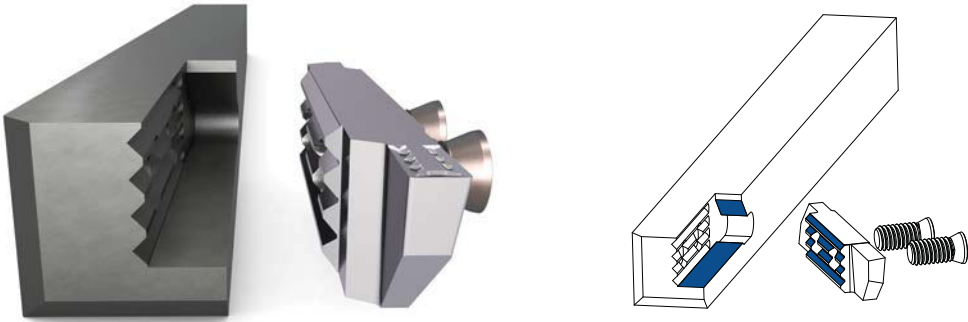

Patented

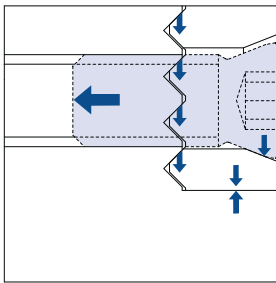

Serrage standard (A)
Standard Spannsystem (A)
Standard clamping system (A)

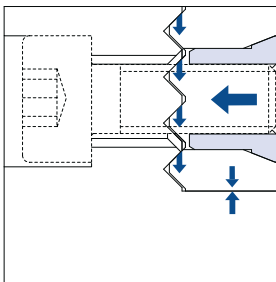
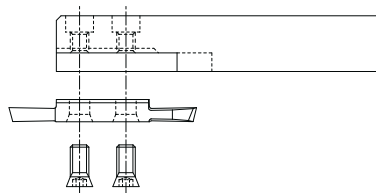

Serrage type B*
Spannsystem Typ B*
Clamping system type B*

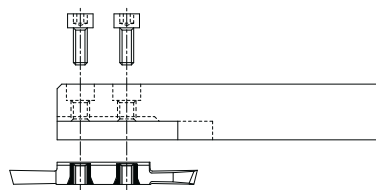

ajouter -B après le numéro d'article
 -B nach der Artikelreferenz hinzufügen
 add -B after the article number

Changement de la plaquette possible dans la machine, sans démontage du porte-outil
 WSP-Austauschmöglichkeit in der Maschine ohne Halterausbau
 The insert can be changed in the machine without removing the tool holder

700-ZX geometries

Très bonne maîtrise du copeau
pour matières difficiles

Sehr gute Spankontrolle für
schwierige Werkstoffe

Very efficient chip control for
difficult materials



Multitude de géométries possibles

Mehrere mögliche Spangeometrien

Many different cutting geometries are possible



700-honed



Géométrie positive 5° avec arête de coupe renforcée (honnée)
Meilleure durée de vie dans l'usinage des matériaux abrasifs (aciers au carbone, aciers alliés)

Positive Geometrie 5° mit verstärkte Schneidkante (gehont)
Bessere Standzeit für die Bearbeitung von abrasive Materialien (Kohlenstoff Stahl, legierter Stahl)

Positive geometry 5° with reinforced cutting edge (honed)
Better tool life for abrasive materials (carbon steel, alloy steel)

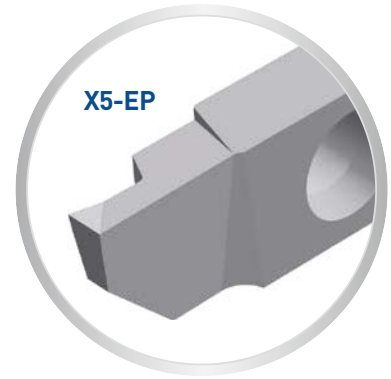





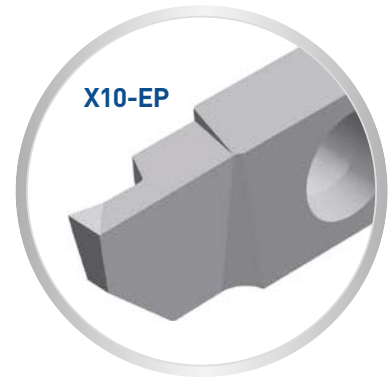

Géométrie positive 10° avec arête de coupe renforcée (honnée)
Meilleure durée de vie dans l'usinage des matériaux tenace (acier inox, inox martensitique)

Positive Geometrie 10° mit verstärkte Schneidkante (gehont)
Bessere Standzeit für die Bearbeitung von zähe Materialien (Rostfreier Stahl, martensitische Rostfreier Stahl)

Positive geometry 10° with reinforced cutting edge (honed)
Better tool life for tough materials (stainless steel, martensitic steel)



Géométries de coupe Spanformgeometrien Cutting geometries	Acier de décolletage Automatenstahl Free-cutting steel	Acier Stahl Steel	Acier inoxydable Rostfreistahl Stainless steel	Aluminium	Titane Titan Titanium	Laiton, bronze Messing, Bronze Brass, bronze	Cuivre Kupfer Copper	★	1 ^{er} choix 1. Wahl 1 st choice
								☆	Recommandé Empfohlen Recommended
								⊙	Pour pièces fragiles de très petits diamètres Für empfindliche und sehr kleine Werkstücke For fragile and very small work pieces
 0°	★	⊙	⊙	⊙	⊙	★	⊙		Permet un réaffûtage aisé Erlaubt einfaches Nachschleifen Allows easy regrinding
 X4°	★	★	★	⊙	⊙		⊙		Réduit l'effort de coupe, réaffûtable Reduziert Schneidkräfte, nachschleifbar Decreases cutting force, allows regrinding
 XF	☆	★	★				☆		Pour matières difficiles (pointe renforcée) Für schwierige Werkstoffe (verstärkte Spitze) For difficult materials (reinforced point)
 X12°			☆	★	★		★		Très bonne maîtrise du copeau Sehr gute Spankontrolle Very efficient chip control
 X25°			☆	★	☆		☆		Pour matières collantes faisant de très longs copeaux Für klebrige Werkstoffe mit sehr langen Spänen For long chipping sticky materials
 U	☆	☆	☆						Pour resserrer le copeau, réaffûtage aisé Für Spanversmälnerung, einfaches Nachschleifen To narrow the chips, easy regrinding
 ZU8	★	★	★	☆ <5% Si	☆	☆			Très bonne maîtrise du copeau (arête de coupe honée) Sehr gute Spankontrolle (gehönte Schneidkante) Very efficient chip control (honed edge) f min: 0.02 mm/U

Conseils d'utilisation

Anwendungsempfehlungen













Application recommendations

Tournage

Drehen

Turning

700 Series

Géométries de coupe Spannformgeometrien Cutting geometries		Acier de décolletage Automatenstahl Free-cutting steel	Acier Stahl Steel	Acier inoxydable Rostfreistahl Stainless steel	Aluminium	Titane Titan Titanium	Laiton, bronze Messing, Bronze Brass, bronze	Cuivre Kupfer Copper	★	1 ^{er} choix 1. Wahl 1 st choice
									☆	Recommandé Empfohlen Recommended
									☑	Pour pièces fragiles de très petits diamètres Für empfindliche und sehr kleine Werkstücke For fragile and very small work pieces
	0°	★	☑	☑	☑	☑	★	☑		Permet un réaffûtage aisé Erlaubt einfaches Nachschleifen Allows easy regrinding
	X	★	★	★	★	★		★		Très bonne maîtrise du copeau Sehr gute Spankontrolle Very efficient chip control
	X5-EP	★	★	☆						Très bonne maîtrise du copeau (arête de coupe honnée) Sehr gute Spankontrolle (gehonte Schneidkante) Very efficient chip control (honed edge) f min: 0.02 mm/U
	X10-EP	☆	☆	★	☆	☆				Très bonne maîtrise du copeau (arête de coupe honnée) Sehr gute Spankontrolle (gehonte Schneidkante) Very efficient chip control (honed edge) f min: 0.02 mm/U
	VX800	★	★	☆	☆	☆		☆		Très bonne maîtrise du copeau Sehr gute Spankontrolle Very efficient chip control
	VX8°	★	★	☆	☆	☆		☆		Très bonne maîtrise du copeau Sehr gute Spankontrolle Very efficient chip control
	VUX	☆	☆	★	☆	★		☆		Roule-copeau bidirectionnel Bidirektionaler Spanrer Bi-directional chip-breaker
	VX15°	☆		☆	★	★		★		Très bonne maîtrise du copeau Sehr gute Spankontrolle Very efficient chip control
	VS	☆		☆	☑	☑		☑		Brise-copeau pour usinage léger en finition Spanbrecher für leichte Schlichtbearbeitung Chip-breaker for light finishing operation
	ZX10	★	★	★	☆ <5% Si	☆	☆			Très bonne maîtrise du copeau Sehr gute Spankontrolle Very efficient chip control f min: 0.02 mm/U
	ZX17			☆	★ <5% Si	★		★		Très bonne maîtrise du copeau Sehr gute Spankontrolle Very efficient chip control f min: 0.02 mm/U
	ZX25			☆	★ <5% Si	★		★		Très bonne maîtrise du copeau Sehr gute Spankontrolle Very efficient chip control f min: 0.02 mm/U
	ZXT	★	★	★	☆ <5% Si	☆	☆			Très bonne maîtrise du copeau Sehr gute Spankontrolle Very efficient chip control f min: 0.02 mm/U

TiAlN

μK20 + revêtement PVD
μK20 + PVD Beschichtung
μK20 + PVD coating

- excellente nuance universelle
- 1^{er} choix pour l'usinage des aciers, aciers inoxydables et alliages de titane
- très bonne résistance à la température

- beste Universalsorte
- für die Bearbeitung von Stahl, rostfreier Stahl und Titanlegierungen bestens geeignet
- sehr gute Warmfestigkeit

- best universal grade
- first choice for steel, stainless steel and titanium alloys machining
- very good heat resistance

TiAlX

μK20 + revêtement PVD
μK20 + PVD Beschichtung
μK20 + PVD coating

- nuance très résistante à l'usure et à la température, recommandée pour l'usinage des matières suivantes: Inox 304, 316L, 317L, 904, Phynox
- aciers alliés contenant: Chrome Nickel, Vanadium, Molybdène, ...

- sehr verschleissfeste und temperaturbeständige Sorte. Für folgende Materialien empfohlen: Inox 304, 316L, 317L, 904, Phynox
- legierter Stahl enthaltend: Chrom-Nickel, Vanadium, Molybdän, ...

- very wear and high temperature resistant grade. Recommended for following material: Inox 304, 316L, 317L, 904, Phynox
- alloy steel containing: Chrome-nickel, Vanadium, Molybdenum, ...

TiN

μK20 + revêtement PVD
μK20 + PVD Beschichtung
μK20 + PVD coating

- nuance pour l'usinage des matières peu résistantes qui créent des arêtes rapportées
- très faible coefficient de frottement
- à éviter pour l'usinage du titane

- Sorte für die Bearbeitung von weichen Werkstoffen mit Tendenz zur Bildung von Aufbauschneiden
- sehr geringer Reibwert
- für die Bearbeitung von Titan nicht geeignet

- grade for the machining of low resistance materials which creates build-up edge
- very low friction ratio
- not suitable for titanium machining

LOX

μK20 + revêtement PVD
μK20 + PVD Beschichtung
μK20 + PVD coating

- nuance résistante à l'usure et à la température, destinée à l'usinage des matières suivantes: Inox, Titanes, alliages à base de Nickel, Chrome Cobalt, les matières avec une dureté supérieure à > 50HRC
- bonne alternative pour l'usinage des aciers de construction types ETG88, ETG100, 36SMnPb14

- verschleissfeste und temperaturbeständige Sorte. Für folgende Materialien empfohlen: Inox, Titan, Nickellegierungen, Chrom-Kobalt, Materialien härter als > 50HRC
- gute Alternative für die Bearbeitung von Baustähle Typ ETG88, ETG100, 36SMnPb14

- wear and high temperature resistant grade. Recommended for following materials: inox, titanium, nickel alloys, materials harder than > 50HRC
- good alternative for machining of structural steels type ETG88, ETG100, 36SMnPb14

N (μK20)

non revêtu
unbeschichtet
uncoated

- supporte les coupes interrompues et autres conditions d'usinage défavorables

- für unterbrochene Schnitte und andere ungünstige Bearbeitungsbedingungen geeignet

- suitable for interrupted cut and other unfavourable machining conditions

Nuances micro-grain à dureté élevée

Verschleissfeste Feinkornsorten

Wear resistant micro-grain grades

μK 10**HTA**

μK10 + revêtement PVD
μK10 + PVD Beschichtung
μK10 + PVD coating

- nuance très résistante à l'usure
- pour l'usinage en finition dans des conditions favorables des aciers, aciers inoxydables et alliages de titane

- sehr verschleissfeste Sorte
- für die Feinbearbeitung von Stahl, rostfreiem Stahl und Titanlegierungen bei guten Bearbeitungsbedingungen

- very wear resistant grade
- for light machining of steel, stainless steel and titanium alloys under favourable machining conditions

HTAX

μK10 + revêtement PVD
μK10 + PVD Beschichtung
μK10 + PVD coating

- nuance très résistante à l'usure et à la température, pour l'usinage en finition avec faibles avances de petites pièces, recommandée pour l'usinage des matières suivantes: Inox 304, 316L, 317L, 904, Phynox
- aciers alliés contenant: Chrome Nickel, Vanadium, Molybdène, ...

- sehr verschleissfeste und temperaturbeständige Sorte. Für Feinbearbeitung von kleinen Teilen mit geringer Vorschub. Für folgende Materialien empfohlen: Inox 304, 316L, 317L, 904, Phynox
- legierter Stahl enthaltend: Chrom-Nickel, Vanadium, Molybdän, ...

- very wear and high temperature resistant grade. For light machining of small parts with low cutting feed. Recommended for following material: Inox 304, 316L, 317L, 904, Phynox
- alloy steel containing: Chrome-nickel, Vanadium, Molybdenum, ...

HTiN

μK10 + revêtement PVD
μK10 + PVD Beschichtung
μK10 + PVD coating

- nuance pour l'usinage en finition des matières peu résistantes qui créent des arêtes rapportées
- très faible coefficient de frottement
- à éviter pour l'usinage du titane

- Sorte für die Feinbearbeitung von weichen Werkstoffen mit Tendenz zur Bildung von Aufbauschneiden
- sehr geringer Reibwert
- für die Bearbeitung von Titan nicht geeignet

- grade for light machining of low resistance materials which creates build-up edge
- very low friction ratio
- not suitable for titanium machining

HAS

μK10 + revêtement PVD
μK10 + PVD Beschichtung
μK10 + PVD coating

- nuance pour métaux non ferreux
- très faible coefficient de frottement
- 1^{er} choix pour l'usinage des aluminiums jusqu'à 5% Si, des cuivres et titanes faiblement alliés

- Sorte für Nichteisenmetalle
- sehr geringer Reibwert
- für die Bearbeitung von Aluminium bis 5% Si, Kupfer und niedriglegiertem Titan bestens geeignet

- grade for non-ferrous materials
- very low friction ratio
- first choice for aluminium up to 5% Si, copper and low alloyed titanium

HN (μK10)

non revêtu
unbeschichtet
uncoated

- nuance micro-grain très résistante à l'usure
- recommandé pour l'usinage du titane faiblement allié
- déconseillé en cas de coupe interrompue et autres conditions d'usinage défavorables

- verschleissfeste Feinkornsorte
- für die Bearbeitung von niedrig legiertem Titan empfehlenswert
- für unterbrochene Schnitte und andere ungünstige Bearbeitungsbedingungen nicht geeignet

- wear resistant micro-grain grade
- suitable for the machining of low alloyed titanium
- not suitable for interrupted cut and other unfavourable machining conditions

Paramètres de coupe indicatifs

Empfohlene Schnittwerte

Standard machining data

Matière Werkstoff Material	Tournage Drehen Turning			Tronçonnage Abstechen Parting off		
	VC	Prof. de passe Schnitttiefe Depth of cut	Avance Vorschub Feed	VC	Largeur de coupe Abstechbreite Cutting width	Avance Vorschub Feed
	(m/min)	(mm)	(mm/U)	(m/min)	(mm)	(mm/U)
Acier de décolletage Automatenstahl Free-cutting steel P	120 - 200	0.05 - 1.0 1.0 - 4.0	0.01 - 0.15 0.05 - 0.25	80 - 150	0.50 - 1.50 1.50 - 3.50	0.01 - 0.08 0.03 - 0.15
Acier Stahl < 600 N/mm ² P	80 - 160	0.05 - 1.0 1.0 - 4.0	0.01 - 0.15 0.05 - 0.25	70 - 120	0.50 - 1.50 1.50 - 3.50	0.01 - 0.06 0.03 - 0.12
Acier Stahl < 800 N/mm ² P	60 - 120	0.05 - 1.0 1.0 - 4.0	0.01 - 0.10 0.05 - 0.20	60 - 100	0.50 - 1.50 1.50 - 3.50	0.01 - 0.05 0.03 - 0.10
Acier Stahl > 800 N/mm ² P	50 - 100	0.05 - 1.0 1.0 - 3.0	0.01 - 0.08 0.05 - 0.15	40 - 80	0.50 - 1.50 1.50 - 3.50	0.01 - 0.04 0.03 - 0.08
Acier inoxydable Rostfreistahl Stainless steel M	60 - 120	0.05 - 1.0 1.0 - 3.0	0.01 - 0.08 0.05 - 0.15	60 - 100	0.50 - 1.50 1.50 - 3.50	0.01 - 0.04 0.03 - 0.08
Aluminium Si <12% N	200 - 1000	0.05 - 1.0 1.0 - 4.0	0.01 - 0.20 0.05 - 0.40	180 - 400	0.50 - 1.50 1.50 - 3.50	0.01 - 0.10 0.03 - 0.20
Aluminium Si >12% N	180 - 800	0.05 - 1.0 1.0 - 4.0	0.01 - 0.20 0.05 - 0.40	150 - 300	0.50 - 1.50 1.50 - 3.50	0.01 - 0.10 0.03 - 0.20
Cuivre, laiton, bronze Kupfer, Messing, Bronze Copper, brass, bronze N	100 - 500	0.05 - 1.0 1.0 - 4.0	0.01 - 0.20 0.05 - 0.35	100 - 300	0.50 - 1.50 1.50 - 3.50	0.01 - 0.10 0.03 - 0.20
Titane Titan Titanium S	30 - 70	0.05 - 1.0 1.0 - 4.0	0.01 - 0.08 0.05 - 0.15	30 - 50	0.50 - 1.50 1.50 - 3.50	0.01 - 0.03 0.03 - 0.06

Indications pour premier réglage

Hinweise für die erste Einrichtung

Indications for first setting

Ébauche Schruppen Roughing	Finition Schlichten Finishing
<ul style="list-style-type: none"> • vitesse de coupe moyenne • avance élevée 	<ul style="list-style-type: none"> • vitesse de coupe élevée • avance faible
<ul style="list-style-type: none"> • durchschnittliche Schnittgeschwindigkeit • hohe Schnittgeschwindigkeit 	<ul style="list-style-type: none"> • hohe Schnittgeschwindigkeit • niedriger Vorschub
<ul style="list-style-type: none"> • average cutting speed • high cutting speed 	<ul style="list-style-type: none"> • high cutting speed • low cutting feed

Remarques importantes
Wichtige Bemerkungen
Important remarks

- en raison des limites de la machine, il n'est souvent pas possible d'atteindre les vitesses de coupe préconisées
- les outils Applitec sont spécialement développés pour permettre de hautes performances, même dans des conditions de coupe défavorables
- des applications non préconisées dans le tableau ci-contre peuvent également s'avérer efficaces





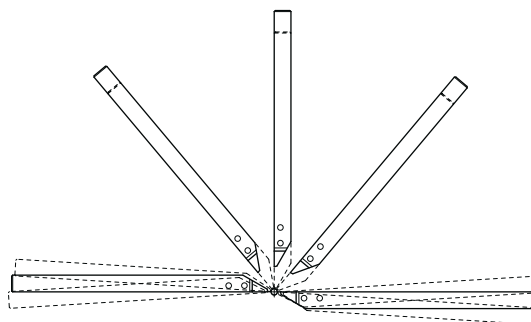

- wegen begrenzter Maschinenleistung ist es oft nicht möglich, die vorgeschlagenen Schnittgeschwindigkeiten zu erreichen
- Applitec Werkzeuge sind besonders dazu entwickelt, um sogar bei ungünstigen Schnittdaten leistungsfähig zu sein
- die in der nebenstehender Tabelle nicht erwähnten Anwendungsfälle können sich auch effizient erweisen

- in many cases, it is impossible to reach the recommended cutting speed, due to the machine limits
- Applitec tools are especially designed to be efficient even in bad cutting conditions
- applications not mentioned in the opposite table can also be efficient

L		R	
Type	Page	Type	Page
710	1.14	720	1.14
710-NOVIBRA	1.15	721	1.16
711	1.16	721-EP	1.23
711-EP	1.23	722	1.17
712	1.17	723-30	1.18
713-30	1.18	723-45	1.19
713-45	1.19	723-60	1.20
713-60	1.20	724	1.21
714	1.21	726	1.22
716	1.22		



Porte-outils et plaquettes pour machines à cames
 Halter und WSP für kurvengesteuerte Maschinen
 Tool holders and inserts for cam driven machines

	710 / 720 Porte-outils Halter Holders	> 1.14
	711 / 721 Tronçonnage Abstechen Parting off	> 1.16
	712 / 722 Tournage avant Vorwärts drehen Front turning	> 1.17
	713 / 723 Tournage arrière Rückwärts drehen Back turning	> 1.18
	714 / 724 Fonçage-tournage Einstechen und drehen Grooving and turning	> 1.21
	716 / 726 Filetage Gewinde drehen Threading	> 1.22
	Plaquette ébauche WSP-Rohling Blank insert	> 1.23

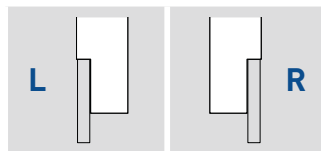
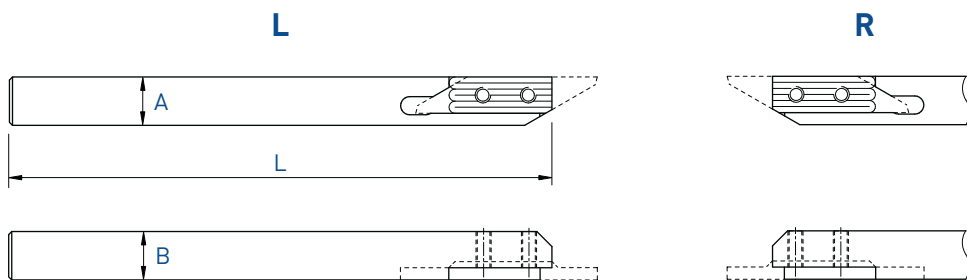

A x B	L	Serrage Spannsystem Clamping	Art. N°	Art. N°
6 x 6	115	A	710-6	-
7 x 7	115	A	710-7	720-7
8 x 8	115	A	710-8	720-8
8 x 8	140	A	710-8-140	-
10 x 10	115	A	710-10	720-10
12 x 12	130	A	710-12	720-12

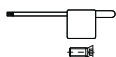

Chaque support est livré avec vis et clé.
 Jeder Halter wird mit Spannschraube(n) und Schlüssel geliefert.
 Screw(s) and key are included with each tool holder.

Porte-outils en métal lourd anti-vibratoire
 Schwingungsdämpfende Schwermetallhalter
 Low vibration heavy metal holders

710-NOVIBRA

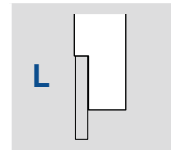
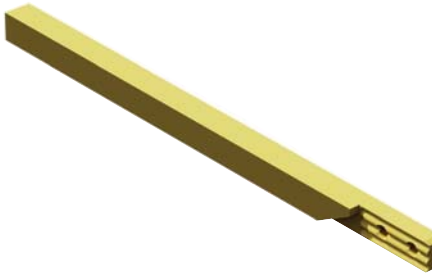
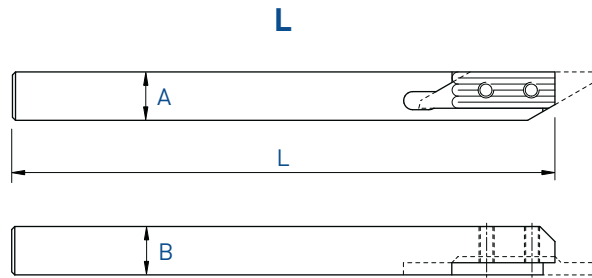

A x B	L	Serrage Spannsystem Clamping	Art. N°
6 x 6	115	A	710-6-NOVIBRA
7 x 7	115	A	710-7-NOVIBRA
8 x 8	115	A	710-8-NOVIBRA



Chaque support est livré avec vis et clé.
 Jeder Halter wird mit Spannschraube(n) und Schlüssel geliefert.
 Screw(s) and key are included with each tool holder.

L

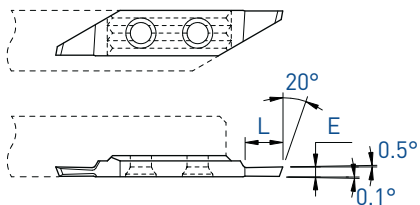

R

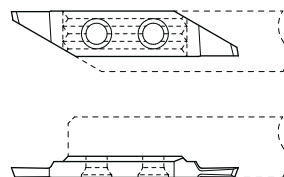

L

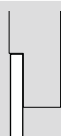

R



E	L	Art. N°	L			R									
			TiAlN	TiN	N (µk20)	HTA	HTiN	HN (µk10)							
0.5	2	711-0.5	■	■	■	■	□	■	-	■	■	■			
0.8	3	711-0.8	■	■	■	■	■	■	721-0.8	■	■	■			
0.9	3	711-0.9	■	■	■	■	□	■	-						
1.0	4	711-1.0	■	■	■	■	■	■	721-1.0	■	■	■	■	□	■
1.1	4	711-1.1	■	■	■	■	■	■	-						
1.2	5	711-1.2	■	■	■	■	■	■	721-1.2	■	■	■	■	□	■
1.3	5	711-1.3	■	■	■	■	□	■	-						
1.4	5	711-1.4	■	■	■				-						
1.5	6.5	711-1.5	■	■	■	■	■	■	721-1.5	■	■	■	■	□	■
1.8	6.5	711-1.8	■	■	■	■	□	■	721-1.8	■	■	■			
2.0	6.5	711-2.0	■	■	■				721-2.0	■	■	■			

Tournage avant
Vorwärts drehen
Front turning

712 / 722

L

R

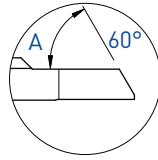
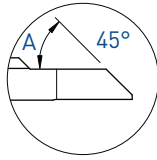
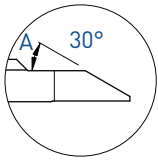
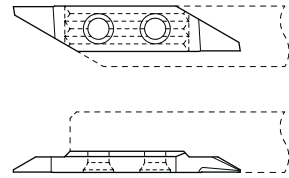
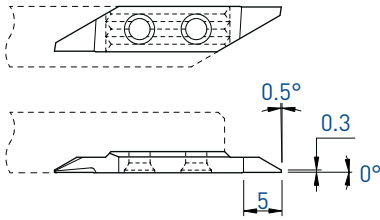

	L						R							
A	Art. N°	TiAlN	TiN	N (µk20)	HTA	HTIN	HN (µk10)	Art. N°	TiAlN	TiN	N (µk20)	HTA	HTIN	HN (µk10)
30°	712-30	■	■	■	■	□	■	722-30	■	■	■	■	□	■
45°	712-45	■	■	■	■	■	■	722-45	■	■	■	■	□	■
60°	712-60	■	■	■	■	□	■	722-60	■	■	■	■	□	■

TOP-LINE

Tournage arrière
Rückwärts drehen
Back turning

713-30° / 723-30°

L

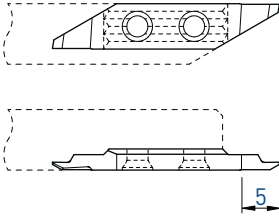

R

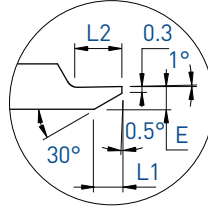
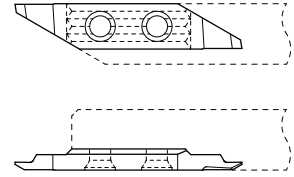

E	~L1	L2	Art. N°	L			R									
				TiAlN	TiN	N (µk20)	HTA	HTiN	HN (µk10)	Art. N°	TiAlN	TiN	N (µk20)	HTA	HTiN	HN (µk10)
0.8	0.85	1.6	713-30-0.8	■	■	■				723-30-0.8	■	■	■	■	□	■
0.9	1.05	1.6	713-30-0.9	■	■	■				-						
1.0	1.2	2.0	713-30-1.0	■	■	■	■	□	■	723-30-1.0	■	■	■	■	□	■
1.1	1.4	2.0	713-30-1.1	■	■	■				-						
1.2	1.55	2.5	713-30-1.2	■	■	■				723-30-1.2	■	■	■			
1.3	1.7	2.5	713-30-1.3	■	■	■				-						
1.4	1.9	3.0	713-30-1.4	■	■	■				-						
1.5	2.1	3.0	713-30-1.5	■	■	■	■	■	■	723-30-1.5	■	■	■	■		
1.8	2.6	4.0	713-30-1.8	■	■	■				723-30-1.8	■	■	■			
2.0	3.0	4.0	713-30-2.0	■	■	■	■	■	■	723-30-2.0	■	■	■			

Tournage arrière
 Rückwärts drehen
 Back turning

713-45° / 723-45°

L

R

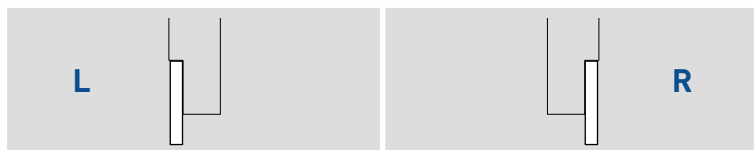
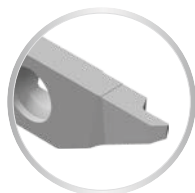
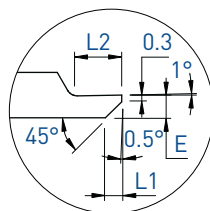
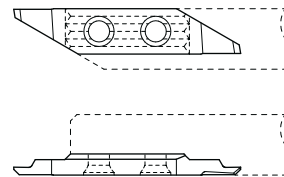
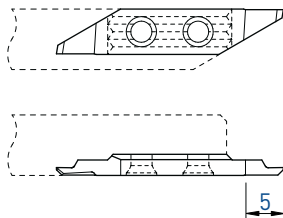

E	-L1	L2	Art. N°	TiAlN	TiN	N (µk20)	HTA	HTiN	HN (µk10)	Art. N°	TiAlN	TiN	N (µk20)	HTA	HTiN	HN (µk10)
0.8	0.5	1.6	713-45-0.8	■	■	■	■	□	■	723-45-0.8	■	■	■			
0.9	0.6	1.6	713-45-0.9	■	■	■				-						
1.0	0.7	2.0	713-45-1.0	■	■	■	■	□	■	723-45-1.0	■	□	■			
1.1	0.8	2.0	713-45-1.1	■	■	■				-						
1.2	0.9	2.5	713-45-1.2	■	■	■				723-45-1.2	■	■	■			
1.3	1.0	2.5	713-45-1.3	■	■	■				-						
1.4	1.1	3.0	713-45-1.4	■	■	■				-						
1.5	1.2	3.0	713-45-1.5	■	■	■	■	■	■	723-45-1.5	■	□	■			
1.8	1.5	4.0	713-45-1.8	■	■	■				723-45-1.8	■	□	■			
2.0	1.7	4.0	713-45-2.0	■	■	■				723-45-2.0	■	■	■			

■ = disponible / verfügbar / available
 □ = selon disponibilité du stock / jenach Lagerverfügbarkeit / depending on stock availability

TOP-LINE

Tournage arrière
Rückwärts drehen
Back turning

713-60° / 723-60°

L

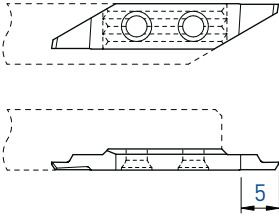

R

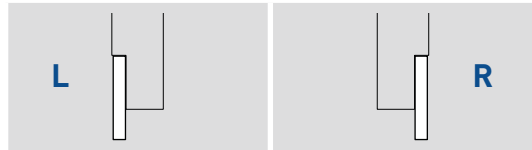
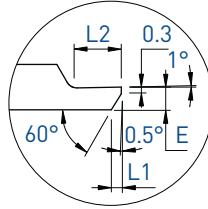
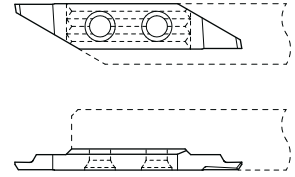

E	~ L1	L2	Art. N°	TiAlN	TiN	N (µk20)	Art. N°	TiAlN	TiN	N (µk20)
0.8	0.3	1.6	713-60-0.8	■	■	■	723-60-0.8	■	■	■
0.9	0.35	1.6	713-60-0.9	■	■	■	-			
1.0	0.4	2.0	713-60-1.0	■	■	■	723-60-1.0	■	□	■
1.1	0.45	2.0	713-60-1.1	■	■	■	-			
1.2	0.5	2.5	713-60-1.2	■	■	■	723-60-1.2	■	□	■
1.3	0.6	2.5	713-60-1.3	■	■	■	-			
1.4	0.65	3.0	713-60-1.4	■	■	■	-			
1.5	0.7	3.0	713-60-1.5	■	■	■	723-60-1.5	■	■	■
1.8	0.85	4.0	713-60-1.8	■	■	■	723-60-1.8	■	□	■
2.0	1.0	4.0	713-60-2.0	■	■	■	723-60-2.0	■	■	■

Fonçage-tournage

Einstecken und drehen

Grooving and turning

714 / 724

L

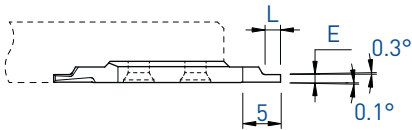
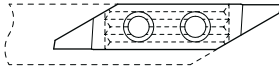

R

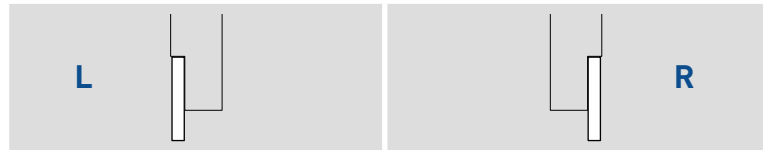
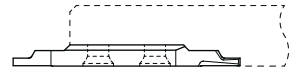
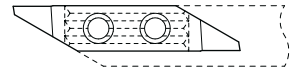

E	L	Art. N°	L			R		
			TiAlN	TiN	N (µk20)	HTA	HTiN	HN (µk10)
0.5	1.0	714-0.5	■	■	■			
0.6	1.0	714-0.6	■	■	■			
0.7	1.5	714-0.7	■	■	■			
0.8	1.5	714-0.8	■	■	■	■	□	■
0.9	2.0	714-0.9	■	■	■			
1.0	2.0	714-1.0	■	■	■	■	■	■
1.1	2.0	714-1.1	■	■	■			
1.2	2.5	714-1.2	■	■	■			
1.3	2.5	714-1.3	■	■	■			
1.4	3.0	714-1.4	■	■	■			
1.5	3.0	714-1.5	■	■	■	■	■	■

TOP-LINE

Filetage
Gewinde drehen
Threading

716 / 726

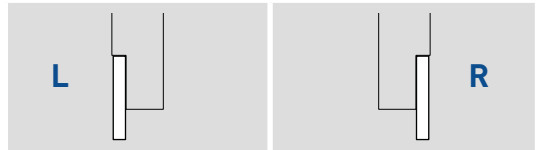
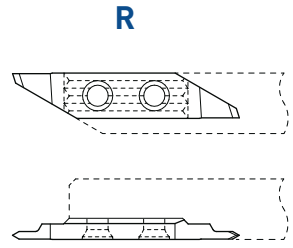
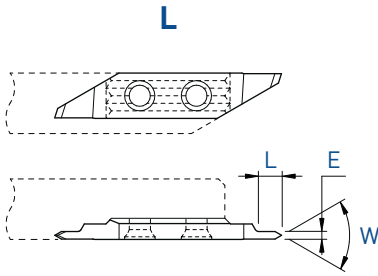

W	E	L	Art. N°	TiAlN	TiN	N (µk20)	Art. N°	TiAlN	TiN	N (µk20)
60°	1.0	3	716-60-1.0	■	■	■	726-60-1.0	■	■	■
60°	1.5	4	716-60-1.5	■	■	■	726-60-1.5	■	■	■
55°	1.0	3	716-55-1.0	■	■	■	726-55-1.0	■	□	■
55°	1.5	4	716-55-1.5	■	■	■	726-55-1.5	■	□	■

Plaquettes ébauches

WSP-Rohlinge

Blank inserts

711-EP / 721-EP

L

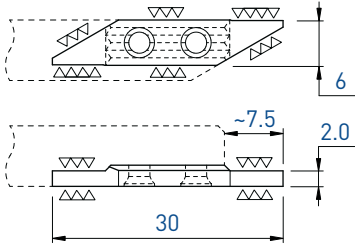

R

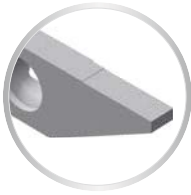
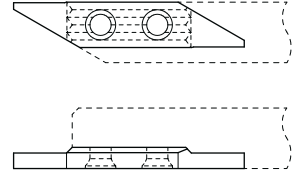

L		R			
Art. N°	TiAlN TiN N (µk20)	HTA HTiN HN (µk10)	Art. N°	TiAlN TiN N (µk20)	HTA HTiN HN (µk10)
711-EP	■ ■ ■	■ □ ■	721-EP	■ □ ■	□ □ ■

L			R		
Type		Page	Type		Page
730	730	1.26	740	740	1.26
	730-JET	1.27		740/730-D	1.31
	730-NOVIBRA	1.30		740-C	1.28
	730RC	1.29		740-JET	1.27
731	731	1.32		740-NOVIBRA	1.30
	731-E	1.67	741	741	1.32
	731-EP	1.67		741-E	1.67
	731N	1.38/1.45		741-EP	1.67
	731R	1.39		741L	1.39
	731RU	1.44		741LX12	1.42
	731RX12	1.42		741LX25	1.43
	731RX25	1.43		741LX4	1.40
	731RX4	1.40		741LXF	1.41
	731RXF	1.41		741N	1.38/1.45
	731U	1.37		741U	1.37
	731X12	1.35		741X12	1.35
	731X25	1.36		741X25	1.36
	731X4	1.33		741X4	1.33
	731XF	1.34		741XF	1.34
732	732	1.46	742	742	1.46
	732PX	1.47		742PX	1.47
	732X	1.48		742X	1.48
733	733	1.49	743	743	1.49
	733P	1.55		743P	1.55
	733VX-15°	1.53		743VX-15°	1.53
	733VX-8°	1.51		743VX-8°	1.51
	733VX-805	1.52		743VX-805	1.52
	733X	1.50		743X	1.50
	733ZX10	1.54		743ZX10	1.54
734	734	1.56	744	744	1.56
	734VS	1.57		744VS	1.57
	734X	1.58		744X	1.58
	734ZX10	1.59		744ZX10	1.59
735	735	1.61		744ZX17	1.59
	735X-90	1.62		744ZXT	1.60
736	736-55	1.63	745	745	1.61
	736-60	1.63		745X-90	1.62
	736-A60°	1.64	746	746-55	1.63
	736-M	1.65		746-60	1.63
737	737	1.66		746-A60°	1.64
				746-M	1.65
			747	747	1.66

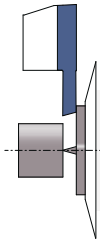
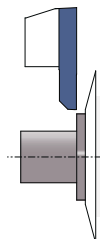
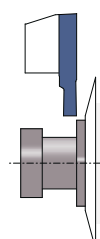
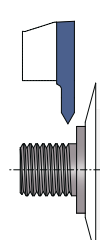
		730 / 740 Porte-outils Halter Holders	> 1.26
	731 / 741 Tronçonnage Abstechen Parting off		> 1.32
		741L / 731R Tronçonnage - coupe déportée Abstechen - versetztes Schneiden Parting off - cut off line	> 1.39
	732 / 742 Tournage avant Vorwärts drehen Front turning		> 1.46
		733 / 743 Tournage arrière Rückwärts drehen Back turning	> 1.49
	734 / 744 Fonçage-tournage Einstechen und drehen Grooving and turning		> 1.56
		735 / 745 Gorges Einstechen Grooving	> 1.61
	736 / 746 Filetage Gewinde drehen Threading		> 1.63
		737 / 747 Plaquettes à rayon Radius Wendeplatten Radius inserts	> 1.66
	Plaquettes ébauches WSP-Rohlinge Blank inserts		> 1.67

L

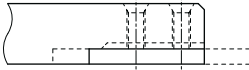
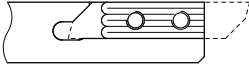

R

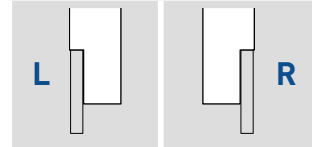
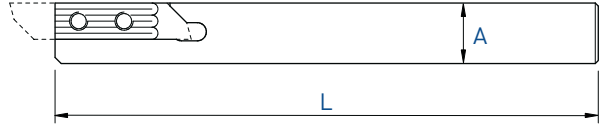

Serrage standard A
Standard Spannsystem A
Standard clamping system A

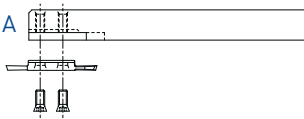

Serrage B
Spannsystem B
Clamping system B

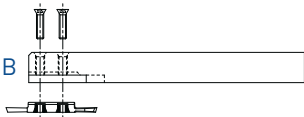

A x B	L	Serrage Spannsystem Clamping	Art. N°	Art. N°
7 x 7	115	A	730-7	740-7
8 x 8	115	A + B	730-8	740-8
8 x 8	140	A + B	730-8-140	-
10 x 10	115	A + B	730-10	740-10
10 x 10	50	A + B	730-10-50	740-10-50
12 x 12	130	A + B	730-12	740-12
12 x 12	90	A + B	730-12-90	740-12-90
12.7 x 12.7	130	A + B	730-12.7	740-12.7
16 x 16	130	A + B	730-16	740-16
16 x 16	75	A + B	730-16-75	740-16-75
20 x 20	120	A + B	730-20	740-20

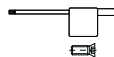

Chaque support est livré avec vis et clé.
Jeder Halter wird mit Spannschraube(n) und Schlüssel geliefert.
Screw(s) and key are included with each tool holder.



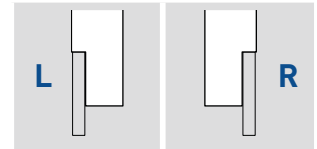
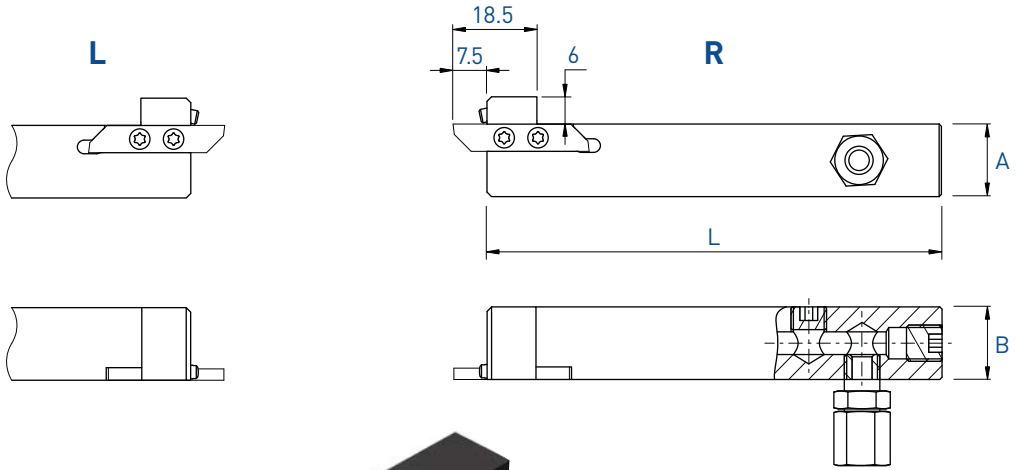

Porte-outils avec arrosage intégré
 Halter mit integrierter Kühlmittelzufuhr
 Holders with integrated coolant supply

730-JET / 740-JET

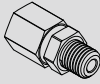

A x B	L	Serrage Spannsystem Clamping	Art. N°	Art. N°
8 x 10	100	A + B	-	740-0810-JET
10 x 12	100	A + B	730-1012-JET	740-1012-JET
12 x 12	100	A + B	730-12-JET	740-12-JET
12.7 x 12.7	100	A + B	730-12.7-JET	740-12.7-JET
16 x 16	100	A + B	730-16-JET	740-16-JET
20 x 20	100	A + B	730-20-JET	740-20-JET



Pièces de rechange Ersatzteile Spare parts			Buse Düse Nozzle 	Option 
	Art. N°	Art. N°	Art. N°	Art. N°
740-0810-JET	J-M5-D5	JB-M5	-	JC-M5-D5
730-JET / 740-JET	J-M8X1-D6	JB-M8X1	JJ-M3X6-D1.5	-

Chaque support est livré avec vis et clé.
 Jeder Halter wird mit Spannschraube(n) und Schlüssel geliefert.
 Screw(s) and key are included with each tool holder.



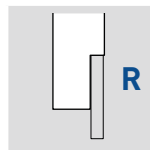
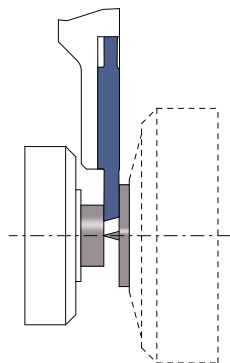
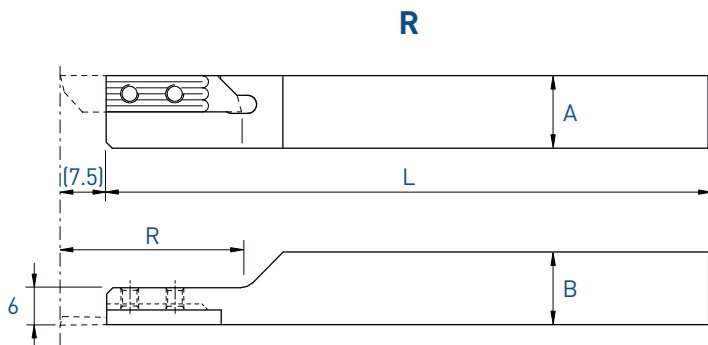

A x B	L	R	Serrage Spansystem Clamping	Art. N°
8 x 8	115	24	A	740-C-8
10 x 10	115	24	A	740-C-10
12 x 12	130	30	A	740-C-12
16 x 16	130	40	A	740-C-16

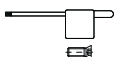

Chaque support est livré avec vis et clé.
Jeder Halter wird mit Spanschraube(n) und Schlüssel geliefert.
Screw(s) and key are included with each tool holder.

Porte-outils

Halter

Holders

Coupe à droite déportée

Versetztes Rechtsschneiden

Right cut off line

730RC

Utiliser des plaquettes type 731R
 WSP Typ 731R verwenden
 Use inserts type 731R

Voir pages 1.39 - 1.45
 Siehe Seiten 1.39 - 1.45
 See pages 1.39 - 1.45

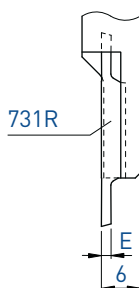
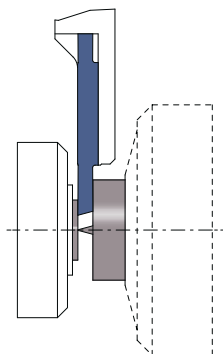
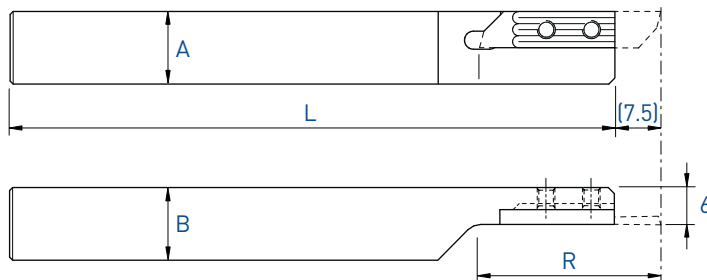
**L (R)**

Coupe à droite déportée
 Versetztes Rechtsschneiden
 Right cut off line

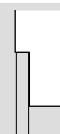

A x B	L	R	Art. N°
8 x 8	115	24	730RC-8
10 x 10	115	24	730RC-10
12 x 12	130	30	730RC-12
16 x 16	130	40	730RC-16

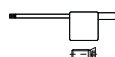

Chaque support est livré avec vis et clé.
 Jeder Halter wird mit Spannschraube(n) und Schlüssel geliefert.
 Screw(s) and key are included with each tool holder.

L

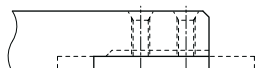
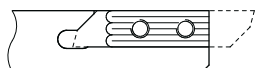

R

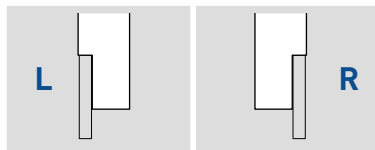
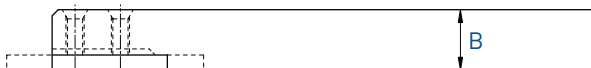
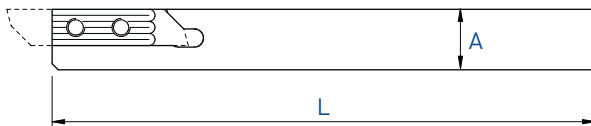

A x B	L	Serrage Spannsystem Clamping	Art. N°	Art. N°
7 x 7	115	A	730-7-NOVIBRA	740-7-NOVIBRA
8 x 8	115	A + B	730-8-NOVIBRA	740-8-NOVIBRA
8 x 8	80	A + B	-	740-8-80-NOVIBRA
10 x 10	115	A + B	-	740-10-NOVIBRA
12 x 12	130	A + B	-	740-12-NOVIBRA

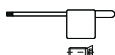

Chaque support est livré avec vis et clé.
 Jeder Halter wird mit Spannschraube(n) und Schlüssel geliefert.
 Screw(s) and key are included with each tool holder.

Porte-outils

Halter

Holders

740 / 730-D

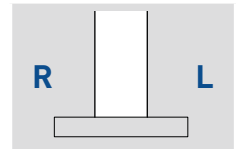
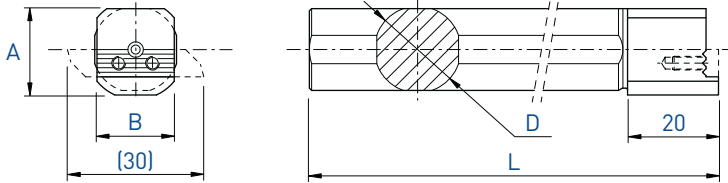

D	L	A	B	Art. N°
16	160	19	17	740/730-D16
19.05	160	19	17	740/730-D19.05
19.05	110	19	17	740/730-D19.05-S
20	160	19.5	17	740/730-D20
22	110	20	17	740/730-D22
25	200	22	17	740/730-D25
25.4	200	22	17	740/730-D25.4

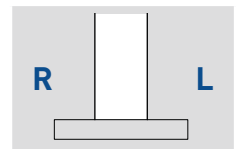
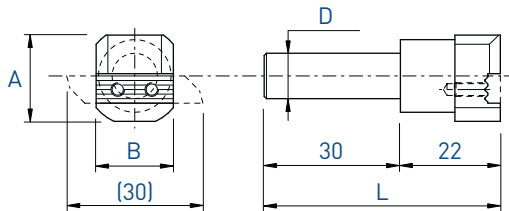

D	L	A	B	Art. N°
10	52	19	17	740/730-D10

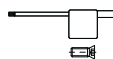

Chaque support est livré avec vis et clé.

Jeder Halter wird mit Spannschraube(n) und Schlüssel geliefert.

Screw(s) and key are included with each tool holder.

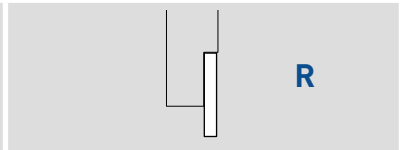
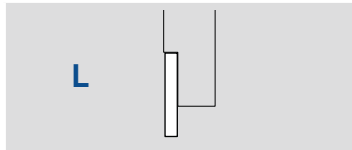
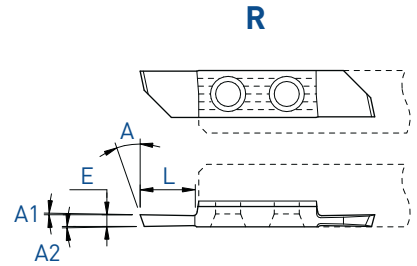
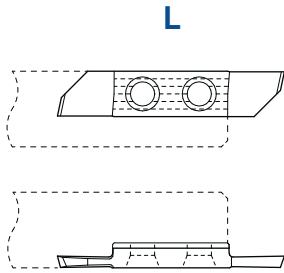

E	A	A1	A2	L	Art. N°	TiAlN	TiN	N (µk20)	HTA	HTiN	HN (µk10)	Art. N°	TiAlN	TiAlX	TiN	N (µk20)	HTA	HTiN	HN (µk10)	
0.6	18°	2.5°	0.5°	3	731-0.6	■	■	■	■	■	■	741-0.6	■	■	■	■	■	■	■	■
0.8	20°	0.3°	0.3°	5	731-0.8	■	■	■	■	□	■	741-0.8	■	■	■	■	■	■	■	■
1.0	20°	0.3°	0.3°	5	731-1.0	■	■	■	■	■	■	741-1.0	■	■	■	■	■	■	■	■
1.2	20°	0.3°	0.3°	5	731-1.2	■	■	■	■	□	■	741-1.2	■	■	■	■	■	■	■	■
1.5	20°	0.3°	0.3°	7	731-1.5	■	■	■	■	■	■	741-1.5	■	■	■	■	■	■	■	■
1.8	20°	0.3°	0.3°	7	731-1.8	■	■	■	■	□	■	741-1.8	■	■	■	■	■	■	□	■
2.0	20°	0.3°	0.3°	7	731-2.0	■	■	■	■	□	■	741-2.0	■	■	■	■	■	■	■	■
2.5	20°	0.3°	0.3°	7	731-2.5	■	■	■	■	■	■	741-2.5	■	■	■	■	■	■	□	■

7XX-XX-B



Sur demande pour serrage type B, voir page 1.03
Wahlweise mit B-Spannsystem, siehe Seite 1.03
On request for B clamping system, see page 1.03

Tronçonnage

Abstechen

Parting off

731X4 / 741X4

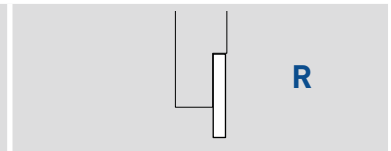
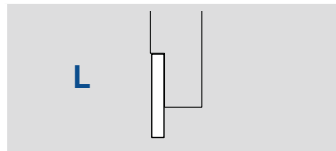
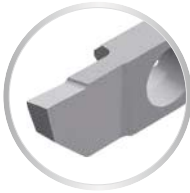
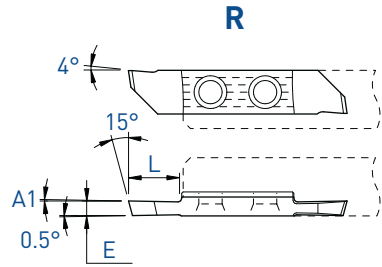
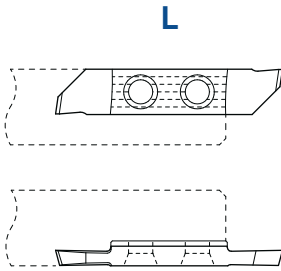

E	A1	L	Art. N°	TiAlN			HTA		HN (µk10)	Art. N°	TiAlN			HTA		HN (µk10)
				Ti	Al	N	HTA	HTiN			Ti	Al	N	HTA	HTiN	
0.6	2.5°	3	731X4-0.6	■	■	■	■	■	741X4-0.6	■	■	■	■	■	■	■
0.8	0.5°	4	-						741X4-0.8							
1.0	0.5°	5	731X4-1.0	■	■	■			741X4-1.0	■	■	■	■	■	□	■
1.5	0.5°	7	731X4-1.5	■	■	■	■	□	741X4-1.5	■	■	■	■	■	□	■
2.0	0.5°	7	731X4-2.0	■	■	■			741X4-2.0	■	■	■	■			

7XX-XX-B



Sur demande pour serrage type B, voir page 1.03
Wahlweise mit B-Spannsystem, siehe Seite 1.03
On request for B clamping system, see page 1.03

■ = disponible / verfügbar / available

□ = selon disponibilité du stock / jenach Lagerverfügbarkeit / depending on stock availability

- Tronçonnage
- Abstechen
- Parting off

731XF / 741XF

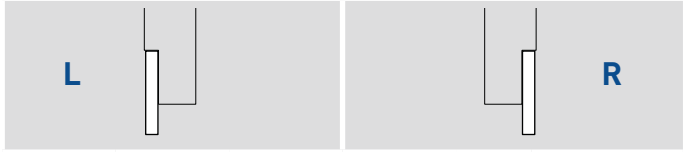
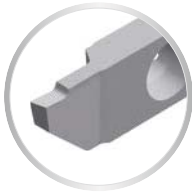
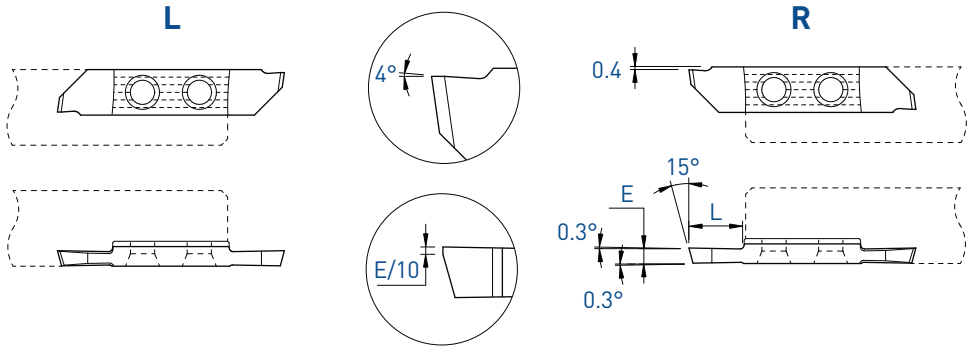

E	L	Art. N°	L			R			Art. N°	R					
			TiAlN	TiN	N (µk20)	HTA	HTiN	HN (µk10)		TiAlN	TiN	N (µk20)	HTA	HTiN	HN (µk10)
1.2	5	-							741XF-1.2	■	□	■			
1.5	7	731XF-1.5	■	■	■	■	■	■	741XF-1.5	■	■	■	■	■	■
2.0	7	731XF-2.0	■	■	■				741XF-2.0	■	■	■	■	■	■
2.5	7	731XF-2.5	■	■	■				741XF-2.5	■	■	■			

7XX-XX-B



Sur demande pour serrage type B, voir page 1.03
 Wahlweise mit B-Spannsystem, siehe Seite 1.03
 On request for B clamping system, see page 1.03

Tronçonnage

Abstechen

Parting off

731X12 / 741X12

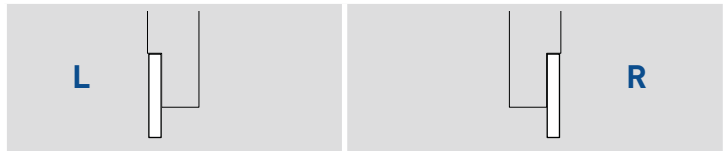
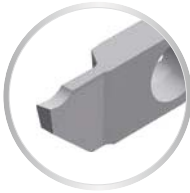
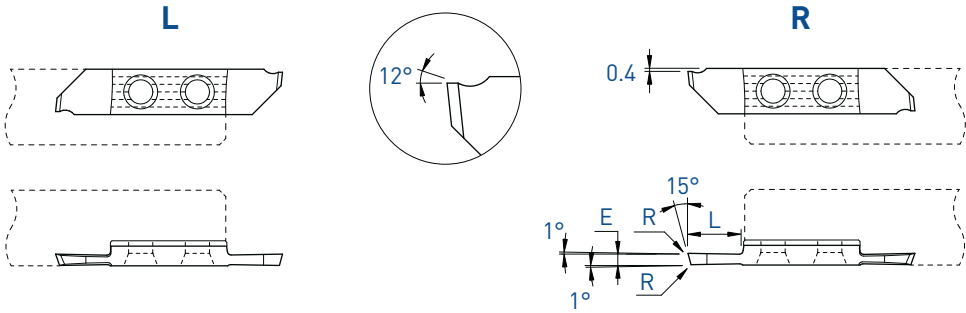

			L				R										
E	L	R	Art. N°	TiAlN	TiN	N (µk20)	HTA	HTiN	HN (µk10)	Art. N°	TiAlN	TiAlX	TiN	N (µk20)	HTA	HTiN	HN (µk10)
0.5	3	0.03	-							741X12-0.5					■		■
1.0	5	0.03	731X12-1.0	■	■	■				741X12-1.0	■	■	■	■	■	□	■
1.5	7	0.03	731X12-1.5	■	■	■				741X12-1.5	■	■	■	■	■	■	■
2.0	7	0.03	731X12-2.0	■	■	■				741X12-2.0	■	■	■	■	■	□	■

7XX-XX-B

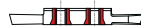

Sur demande pour serrage type B, voir page 1.03
Wahlweise mit B-Spannsystem, siehe Seite 1.03
On request for B clamping system, see page 1.03

■ = disponible / verfügbar / available

□ = selon disponibilité du stock / jenach Lagerverfügbarkeit / depending on stock availability

Tronçonnage
Abstechen
Parting off

731X25 / 741X25

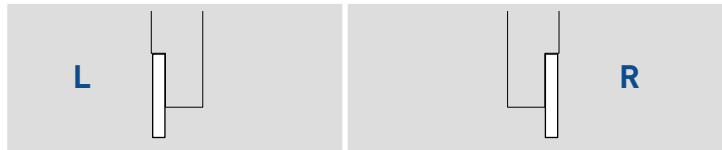
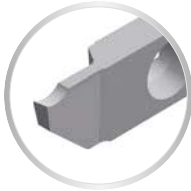
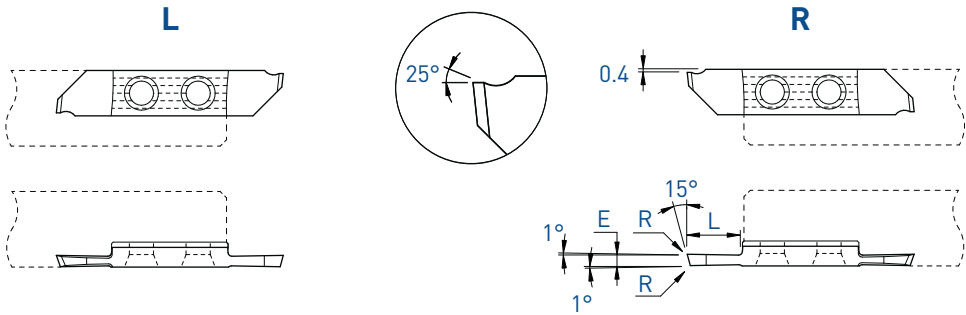

E	L	Art. N°	L			R			HTA	HTiN	HN (µk10)
			TiAlN	TiN	N (µk20)	TiAlN	TiAlX	TiN			
1.0	5	731X25-1.0	■	■	■				■	□	■
1.5	7	731X25-1.5	■	■	■				■	□	■
2.0	7	731X25-2.0	■	■	■				■	□	■

7XX-XX-B



Sur demande pour serrage type B, voir page 1.03
Wahlweise mit B-Spannsystem, siehe Seite 1.03
On request for B clamping system, see page 1.03

Tronçonnage

Abstechen

Parting off

731U / 741U

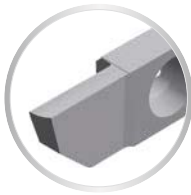
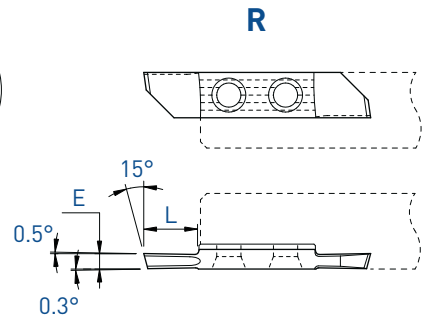
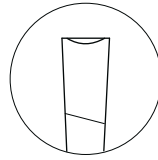
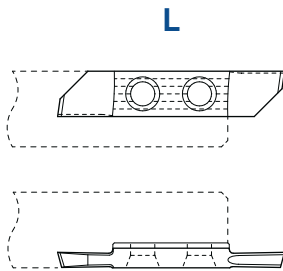

L



R



E	L	Art. N°	TiAlN	TiN	N (µk20)	HTA	HTiN	HN (µk10)	Art. N°	TiAlN	TiN	N (µk20)	HTA	HTiN	HN (µk10)
1.5	7	731U-1.5	■	■	■	■	□	■	741U-1.5	■	■	■	■	■	■
2.0	7	731U-2.0	■	■	■	■	□	■	741U-2.0	■	■	■	■	□	■

7XX-XX-B



Sur demande pour serrage type B, voir page 1.03
Wahlweise mit B-Spannsystem, siehe Seite 1.03
On request for B clamping system, see page 1.03

■ = disponible / verfügbar / available

□ = selon disponibilité du stock / jenach Lagerverfügbarkeit / depending on stock availability

Tronçonnage

Abstechen

Parting off

731N / 741N

L

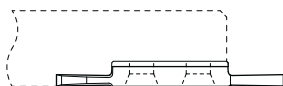
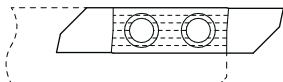

R

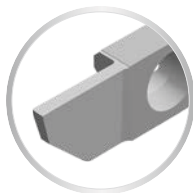
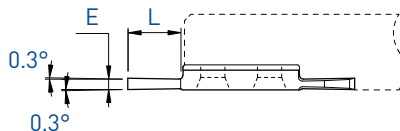
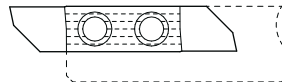

L

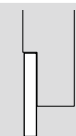

R



E	L	Art. N°	TiAlN	TiN	N (µk20)	HTA	HTiN	HN (µk10)	Art. N°	TiAlN	TiN	N (µk20)	HTA	HTiN	HN (µk10)
1.0	5	731N-1.0	■	■	■	■	□	■	741N-1.0	■	■	■	■	□	■
1.5	7	731N-1.5	■	■	■	■	□	■	741N-1.5	■	■	■	■	□	■

7XX-XX-B



Sur demande pour serrage type B, voir page 1.03
Wahlweise mit B-Spannsystem, siehe Seite 1.03
On request for B clamping system, see page 1.03

Tronçonnage
Abstechen
Parting off

Coupe déportée
Versetztes Schneiden
Cut off line

741L / 731R

Cut L

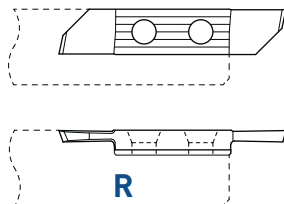

Cut R

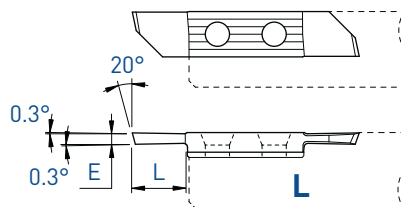

R (L)

Coupe à gauche déportée
Versetztes Linksschneiden
Left cut off line

L (R)

Coupe à droite déportée
Versetztes Rechtsschneiden
Right cut off line

E	L	Art. N°	TiAlN	TiN	N (µk20)	HTA	HTiN	HN (µk10)	Art. N°	TiAlN	TiN	N (µk20)	HTA	HTiN	HN (µk10)
1.0	5	741L-1.0	■	■	■	■	□	■	731R-1.0	■	■	■	■	■	■
1.2	5	741L-1.2	■	■	■	■	□	■	731R-1.2	■	■	■	■	□	■
1.5	7	741L-1.5	■	■	■	■	■	■	731R-1.5	■	■	■	■	■	■
2.0	7	741L-2.0	■	■	■	■	□	■	731R-2.0	■	■	■	■	□	■
2.5	7	741L-2.5	■	■	■				731R-2.5	■	■	■			

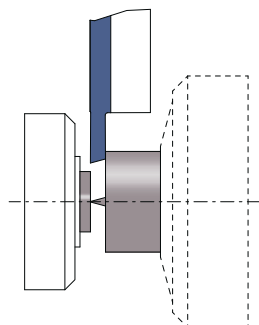

Tronçonnage
Abstechen
Parting off

Coupe déportée
Versetztes Schneiden
Cut off line

741LX4 / 731RX4

Cut L

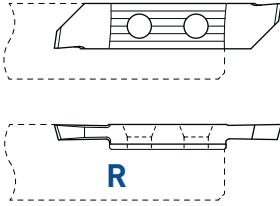

Cut R

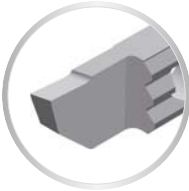
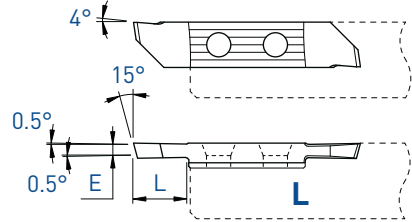

R (L)

Coupe à gauche déportée
Versetztes Linksschneiden
Left cut off line

L (R)

Coupe à droite déportée
Versetztes Rechtsschneiden
Right cut off line

E	L	Art. N°	TiAlN	TiN	N (µk20)	HTA	HTiN	HN (µk10)	Art. N°	TiAlN	TiN	N (µk20)	HTA	HTiN	HN (µk10)
1.5	5	741LX4-1.5	■	■	■				731RX4-1.5	■	■	■	■	■	■

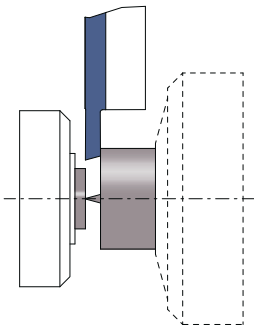

Tronçonnage
Abstechen
Parting off

Coupe déportée
Versetztes Schneiden
Cut off line

741LXF / 731RXF

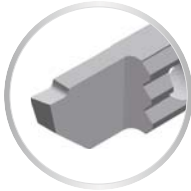
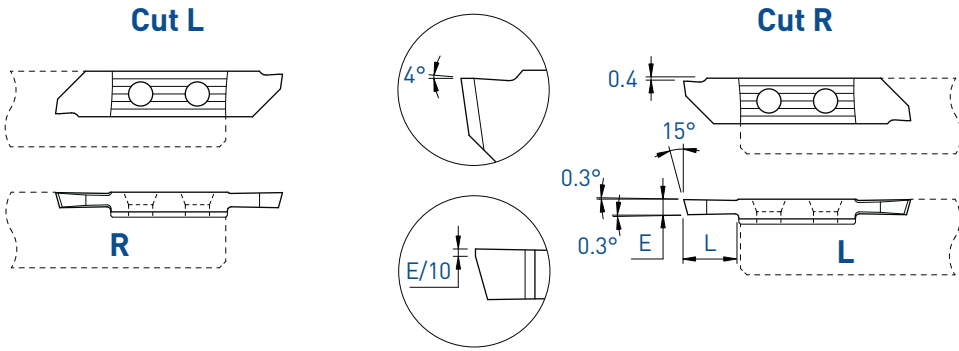

R (L)	L (R)
Coupe à gauche déportée Versetztes Linksschneiden Left cut off line	Coupe à droite déportée Versetztes Rechtsschneiden Right cut off line

E	L	Art. N°	TiAlN	TiN	N (µk20)	HTA	HTiN	HN (µk10)	Art. N°	TiAlN	TiN	N (µk20)	HTA	HTiN	HN (µk10)
1.5	7	741LXF-1.5	■	■	■				731RXF-1.5	■	■	■	■	■	■
2.0	7	741LXF-2.0	■	■	■				731RXF-2.0	■	■	■	■	□	■
2.5	7	741LXF-2.5	■	■	■				731RXF-2.5	■	■	■	■		

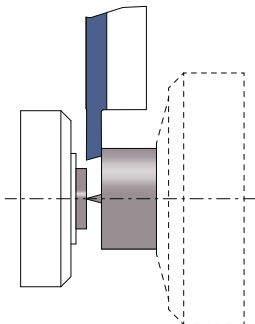

Tronçonnage
Abstechen
Parting off

Coupe déportée
Versetztes Schneiden
Cut off line

741LX12 / 731RX12

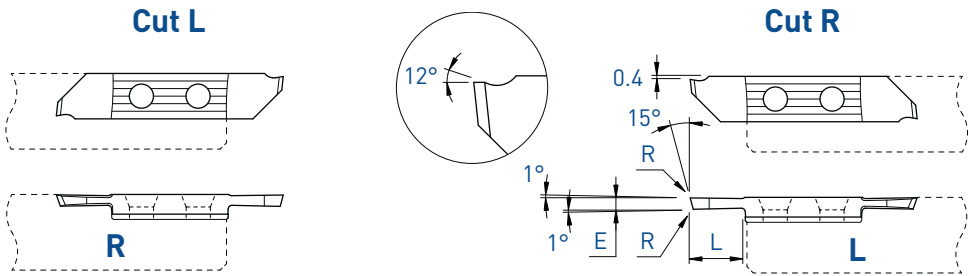

R (L)

Coupe à gauche déportée
Versetztes Linksschneiden
Left cut off line

L (R)

Coupe à droite déportée
Versetztes Rechtsschneiden
Right cut off line

E	L	R	Art. N°	TiAlN	TiN	N (µk20)	HTA	HTiN	HN (µk10)	Art. N°	TiAlN	TiN	N (µk20)	HTA	HTiN	HN (µk10)
1.0	5	0.03	-							731RX12-1.0	■	□	■			
1.5	7	0.03	741LX12-1.5	■	■	■				731RX12-1.5	■	■	■	■	■	■

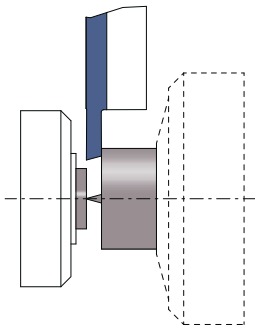

Tronçonnage
Abstechen
Parting off

Coupe déportée
Versetztes Schneiden
Cut off line

741LX25 / 731RX25

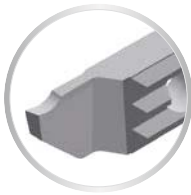
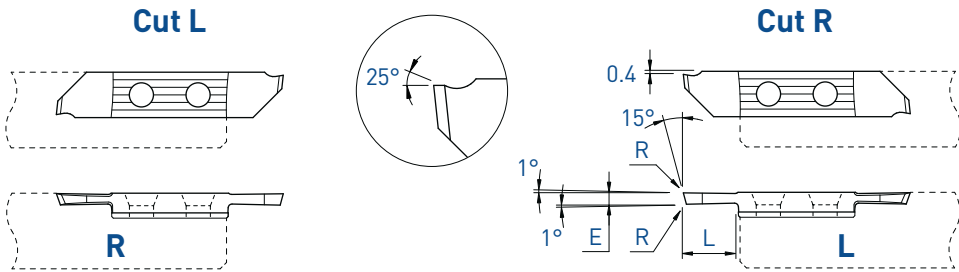

R (L)			L (R)		
Coupe à gauche déportée Versetztes Linksschneiden Left cut off line			Coupe à droite déportée Versetztes Rechtsschneiden Right cut off line		

E	L	R	Art. N°	TiAlN	TiN	N (µk20)	Art. N°	TiAlN	TiN	N (µk20)
1.5	7	0.03	741LX25-1.5	■	■	■	731RX25-1.5	■	■	■

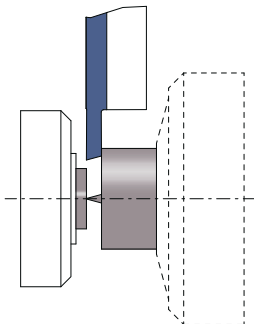

Tronçonnage

Abstechen

Parting off

Coupe déportée

Versetztes Schneiden

Cut off line

731RU

Cut R

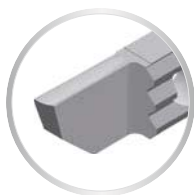
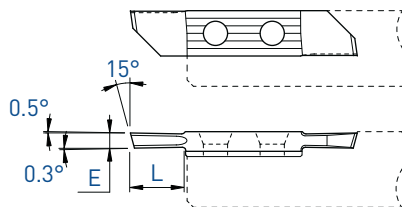
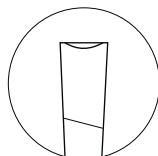

L (R)

Coupe à droite déportée
Versetztes Rechtsschneiden
Right cut off line

E	L	Art. N°	TiAlN	TiN	N (µk20)	HTA	HTiN	HN (µk10)
1.0	5	731RU-1.0	■	□	■			
1.2	5	731RU-1.2	■	□	■			
1.5	7	731RU-1.5	■	□	■	■	□	■
2.0	7	731RU-2.0	■	□	■			

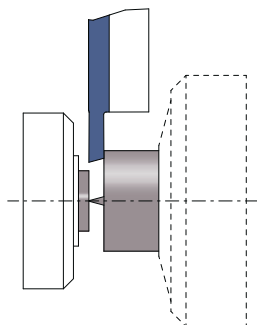

Tronçonnage
Abstechen
Parting off

Coupe déportée
Versetztes Schneiden
Cut off line

741N / 731N

Cut L

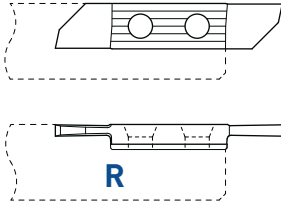

Cut R

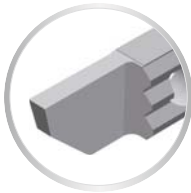
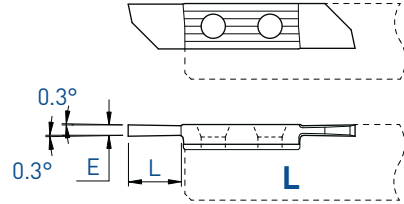

R (L)

Coupe à gauche déportée
Versetztes Linksschneiden
Left cut off line

L (R)

Coupe à droite déportée
Versetztes Rechtsschneiden
Right cut off line

E	L	Art. N°	TiAlN	TiN	N (µk20)	HTA	HTiN	HN (µk10)	Art. N°	TiAlN	TiN	N (µk20)	HTA	HTiN	HN (µk10)
1.0	5	741N-1.0	■	■	■	■	□	■	731N-1.0	■	■	■	■	□	■
1.5	7	741N-1.5	■	■	■	■	□	■	731N-1.5	■	■	■	■	□	■

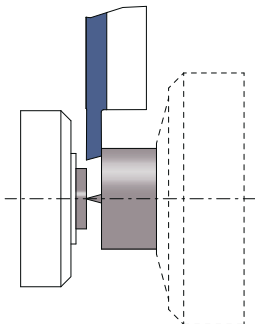

TOP-LINE

Tournage avant
Vorwärts drehen
Front turning

732 / 742

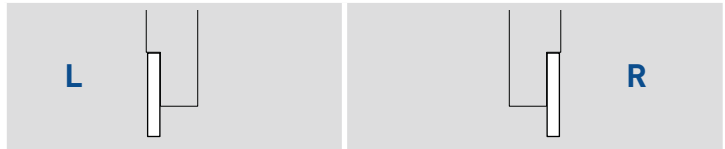
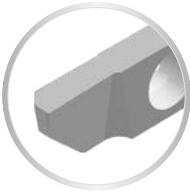
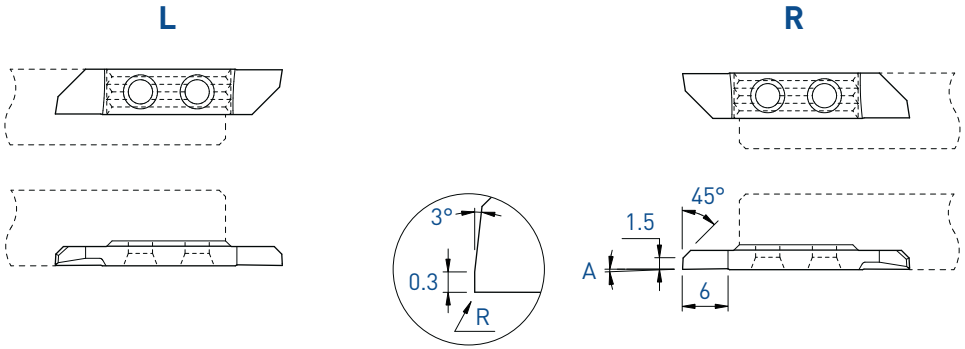

A	R	Art. N°	TiAlN	TiN	N (µk20)	HTA	HTiN	HN (µk10)	Art. N°	TiAlN	TiAlX	TiN	N (µk20)	HTA	HTiN	HN (µk10)
0°	0	732	■	■	■	■	■	■	742	■	■	■	■	■	■	■
2°	0	732-2°	■	■	■	■	□	■	742-2°	■	■	■	■	■	■	■

7XX-XX-B



Sur demande pour serrage type B, voir page 1.03
Wahlweise mit B-Spannsystem, siehe Seite 1.03
On request for B clamping system, see page 1.03

Tournage avant
Vorwärts drehen
Front turning

732PX / 742PX

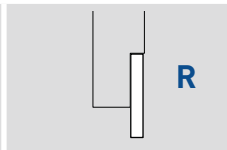
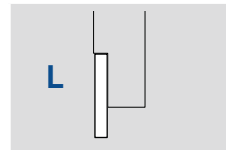
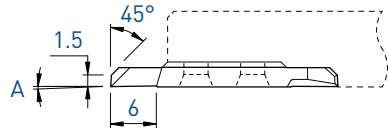
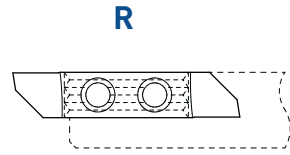
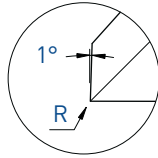
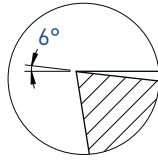
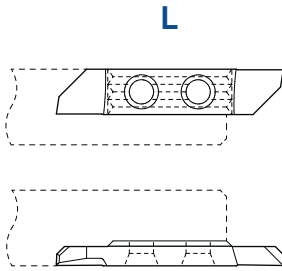

A	R	Art. N°	TiAlN	TiN	N (µk20)	Art. N°	TiAlN	TiN	N (µk20)
0°	0	732PX	■	■	■	742PX	■	■	■

7XX-XX-B



Sur demande pour serrage type B, voir page 1.03
Wahlweise mit B-Spannsystem, siehe Seite 1.03
On request for B clamping system, see page 1.03

■ = disponible / verfügbar / available
□ = selon disponibilité du stock / jenach Lagerverfügbarkeit / depending on stock availability

TOP-LINE

Tournage avant
Vorwärts drehen
Front turning

732X / 742X

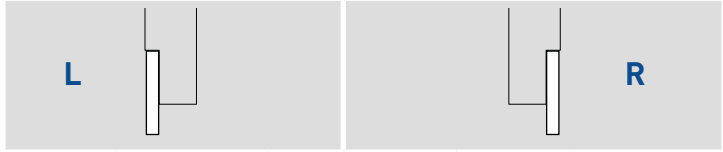
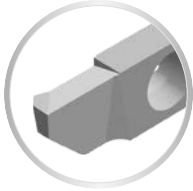
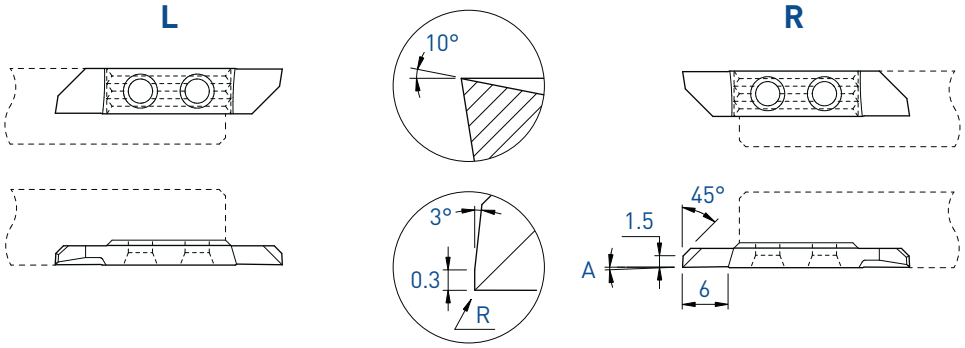

A	R	Art. N°	TiAlN	TiN	N (µk20)	HTA	HTiN	HN (µk10)	Art. N°	TiAlN	TiAlX	TiN	N (µk20)	HTA	HTiN	HN (µk10)
0°	0	732X	■	■	■	■	■	■	742X	■	■	■	■	■	■	■

7XX-XX-B Sur demande pour serrage type B, voir page 1.03
Wahlweise mit B-Spannsystem, siehe Seite 1.03
On request for B clamping system, see page 1.03



Tournage arrière
 Rückwärts drehen
 Back turning

733 / 743

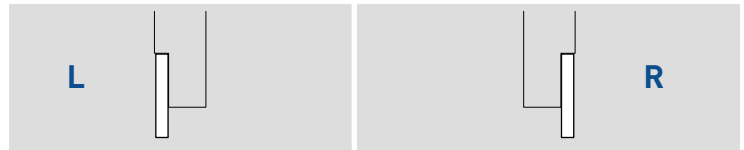
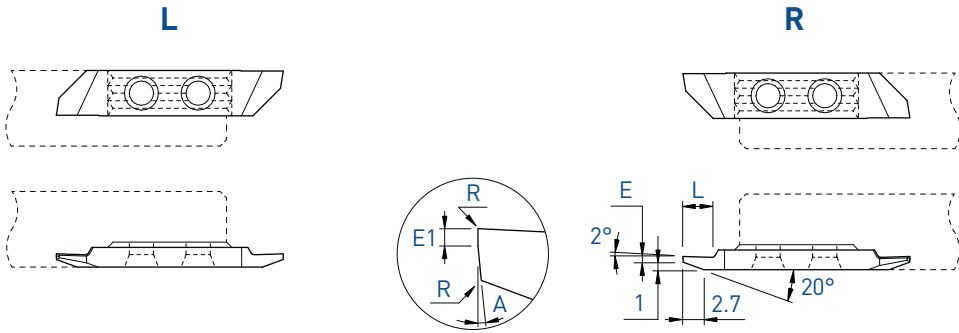

E	E1	A	L	R	Art. N°	TiAlN	TiN	N (µk20)	HTA	HTiN	HN (µk10)	Art. N°	TiAlN	TiAlX	TiN	N (µk20)	HTA	HTiN	HN (µk10)	
0.5	0.25	3°	3	0	733-0.5	■	■	■	■	□	■	743-0.5	■	■	■	■	■	■	■	■
0.5	-	2°	3	0.08	733-0.5-R08	■	■	■	■	□	■	743-0.5-R08	■	■	■	■	■	■	□	■
0.8	0.30	3°	4	0	733-0.8	■	■	■	■	□	■	743-0.8	■	■	■	■	■	■	□	■
1.0	0.40	3°	4	0	733-1.0	■	■	■	■	□	■	743-1.0	■	■	■	■	■	■	□	■
1.2	0.50	3°	5	0	733-1.2	■	■	■	■	□	■	743-1.2	■	■	■	■	■	■	□	■
1.5	0.50	3°	6	0	733-1.5	■	■	■	■	□	■	743-1.5	■	■	■	■	■	■	□	■

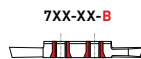

7XX-XX-B Sur demande pour serrage type B, voir page 1.03
 Wahlweise mit B-Spannsystem, siehe Seite 1.03
 On request for B clamping system, see page 1.03

■ = disponible / verfügbar / available
 □ = selon disponibilité du stock / jenach Lagerverfügbarkeit / depending on stock availability

TOP-LINE

Tournage arrière
Rückwärts drehen
Back turning

733X / 743X

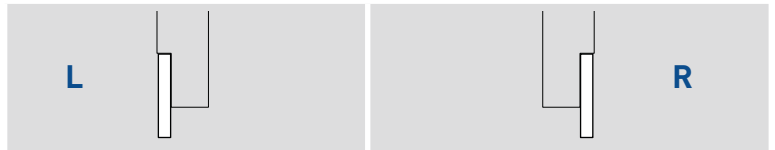
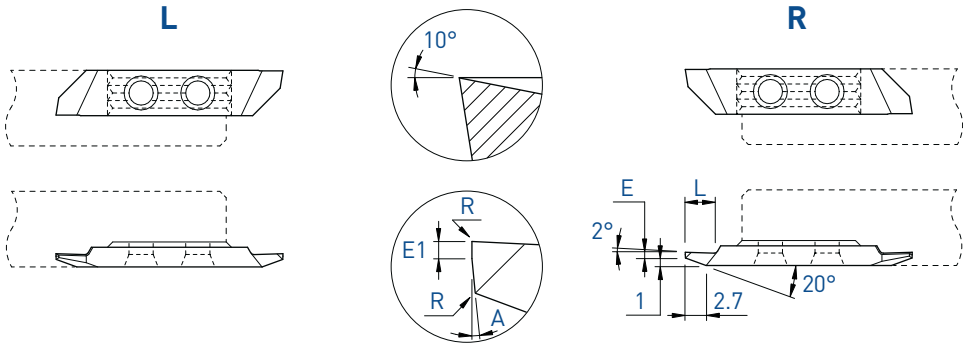

					L					R									
E	E1	A	L	R	Art. N°	TiAlN	TiN	N (µk20)	HTA	HTiN	HN (µk10)	Art. N°	TiAlN	TiAlX	TiN	N (µk20)	HTA	HTiN	HN (µk10)
0.5	0.25	3°	3	0	733X-0.5	■	■	■	■	□	■	743X-0.5	■	■	■	■	■	□	■
0.5	-	2°	3	0.08	733X-0.5-R08	■	■	■				743X-0.5-R08	■	■	■	■	■	□	■
0.8	0.30	3°	4	0	733X-0.8	■	■	■				743X-0.8	■	■	■	■	■	□	■
1.0	0.40	3°	4	0	733X-1.0	■	■	■				743X-1.0	■	■	■	■	■	□	■
1.2	0.50	3°	5	0	733X-1.2	■	■	■				743X-1.2	■	■	■	■	■	□	■
1.5	0.50	3°	6	0	733X-1.5	■	■	■				743X-1.5	■	■	■	■	■	□	■

7XX-XX-B



Sur demande pour serrage type B, voir page 1.03
Wahlweise mit B-Spannsystem, siehe Seite 1.03
On request for B clamping system, see page 1.03

Tournage arrière
Rückwärts drehen
Back turning

733VX-8° / 743VX-8°

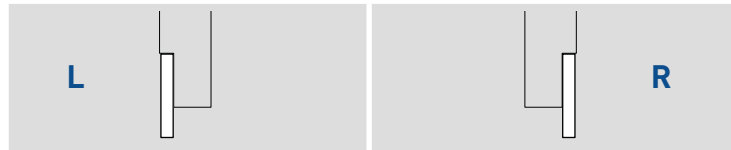
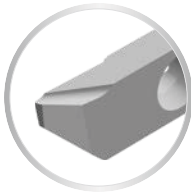
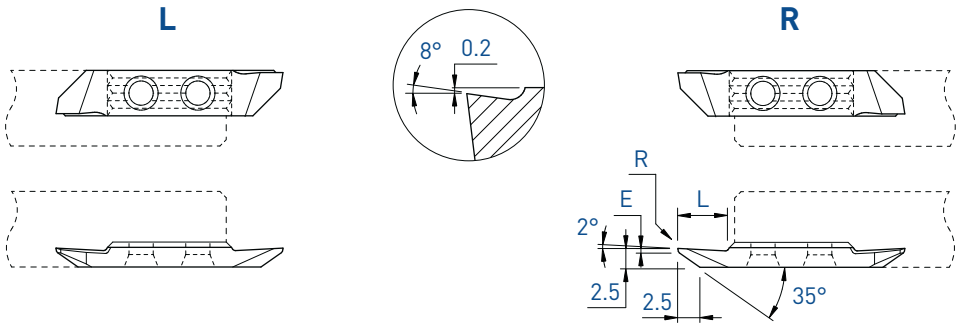

E	L	R	Art. N°	TiAlN	TiN	N (µk20)	HTA	HTiN	HN (µk10)	Art. N°	TiAlN	TiN	N (µk20)	HTA	HTiN	HN (µk10)
~ 1.0	6.5	0	733VX-8°	■	■	■	■	■	■	743VX-8°	■	■	■	■	■	■
~ 1.0	6.5	0.08	733VX-8°-R08	■	■	■	■	□	■	743VX-8°-R08	■	■	■	■	□	■

7XX-XX-B



Sur demande pour serrage type B, voir page 1.03
Wahlweise mit B-Spannsystem, siehe Seite 1.03
On request for B clamping system, see page 1.03

■ = disponible / verfügbar / available
□ = selon disponibilité du stock / jenach Lagerverfügbarkeit / depending the stock availability

Tournage arrière
 Rückwärts drehen
 Back turning

733VX-805 / 743VX-805

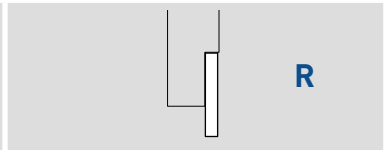
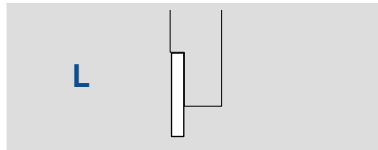
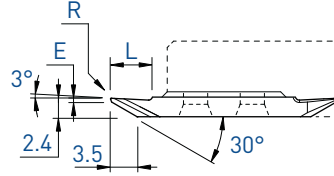
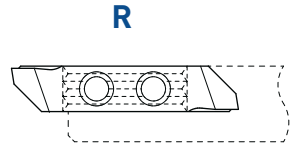
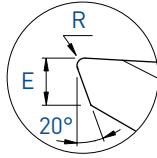
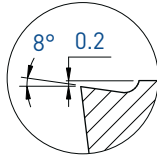
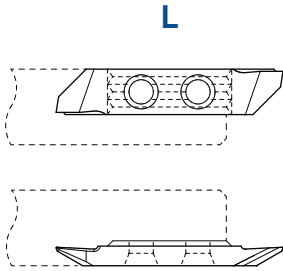

E	L	R	Art. N°	TiAlN	TiN	N (µk20)	HTA	HTiN	HN (µk10)	Art. N°	TiAlN	TiN	N (µk20)	HTA	HTiN	HN (µk10)
0.5	6	0.08	733VX-805-R08	■	□	■	■	□	■	743VX-805-R08	■	■	■	■	□	■

7XX-XX-B



Sur demande pour serrage type B, voir page 1.03
 Wahlweise mit B-Spannsystem, siehe Seite 1.03
 On request for B clamping system, see page 1.03

Tournage arrière
 Rückwärts drehen
 Back turning

733VX-15° / 743VX-15°

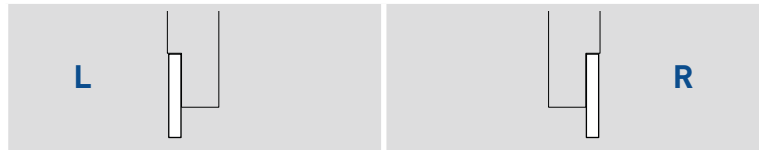
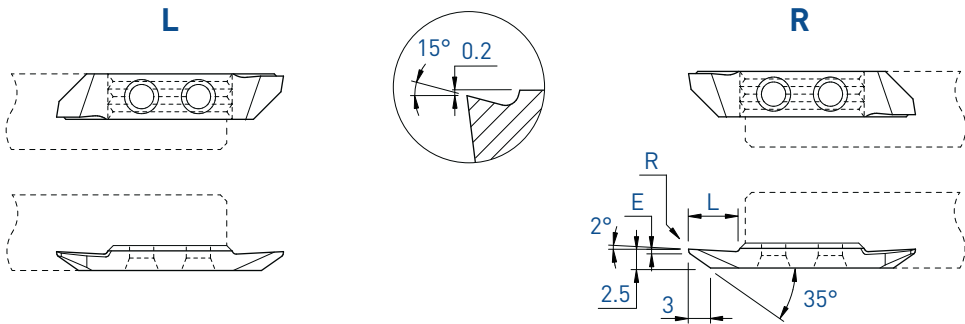

E	L	R	Art. N°	TiAlN	TiN	N (µk20)	HTA	HTiN	HN (µk10)	Art. N°	TiAlN	TiN	N (µk20)	HTA	HTiN	HN (µk10)
0.5	6.5	0	733VX-15°	■	■	■	■	□	■	743VX-15°	■	■	■	■	□	■
0.5	6.5	0.08	733VX-15°-R08	■	■	■				743VX-15°-R08	■	■	■	■	□	■

7XX-XX-B



Sur demande pour serrage type B, voir page 1.03
 Wahlweise mit B-Spannsystem, siehe Seite 1.03
 On request for B clamping system, see page 1.03

■ = disponible / verfügbar / available
 □ = selon disponibilité du stock / jenach Lagerverfügbarkeit / depending on stock availability

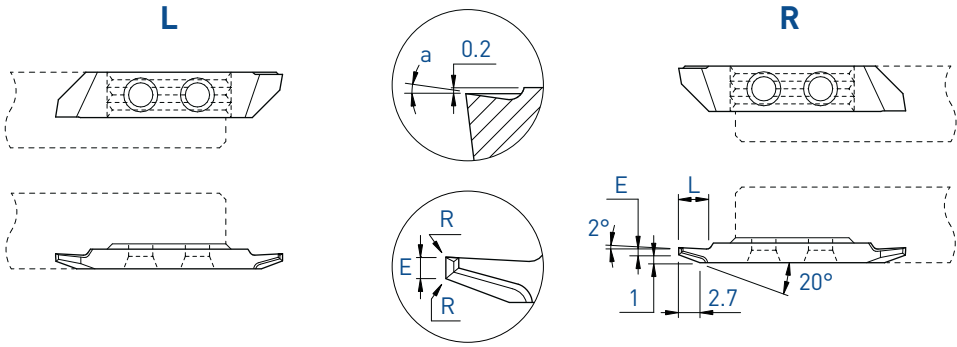

Pour un meilleur contrôle des copeaux
Für eine bessere Spankontrolle
For a better chip-control

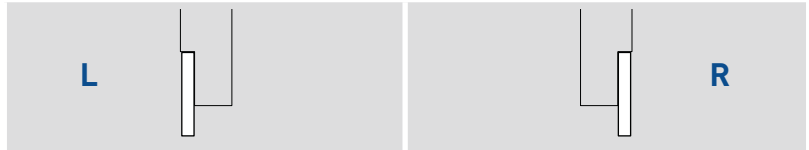

a	E	L	R	Art. N°	L			R							
					TiAlN	TiN	N (µk20)	HTA	HTiN	HN (µk10)	Art. N°	TiAlN	TiN	N (µk20)	HTA
10°	1.0	4	0.01	733ZX10-1.0	■	□					743ZX10-1.0	■	□	■	□
	1.0	4	0.08	733ZX10-1.0-R08	■	□					743ZX10-1.0-R08	■	□	■	□

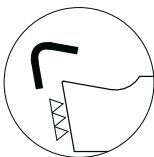

Arête de coupe honée
Gehonte Schneidkante
Honed edge

f min: 0.02 mm/U



7XX-XX-B

Sur demande pour serrage type B, voir page 1.03
Wahlweise mit B-Spannsystem, siehe Seite 1.03
On request for B clamping system, see page 1.03

Tournage arrière / pré-coupe
 Rückwärts drehen / vorstechen
 Back turning / pre-parting off

733P / 743P

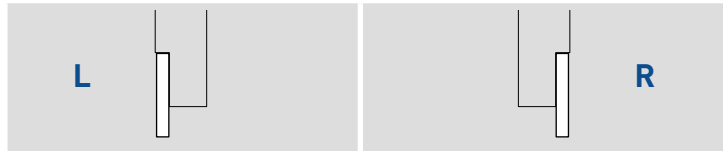
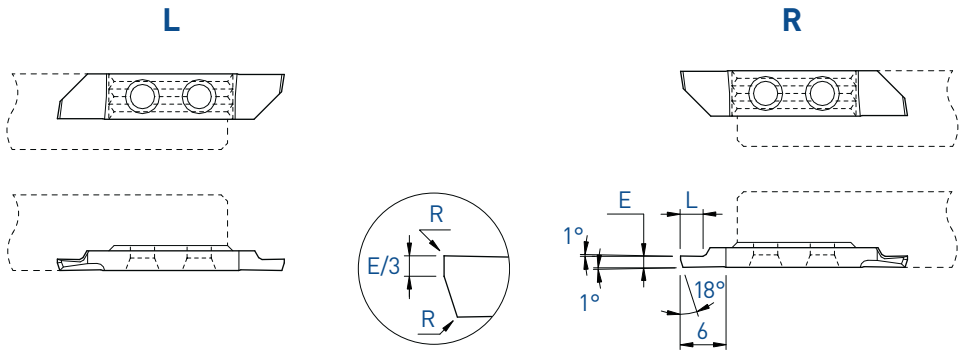

E	L	R	Art. N°	L			R												
				TiAlN	TiN	N (µk20)	HTA	HTiN	HN (µk10)	Art. N°	TiAlN	TiN	N (µk20)	HTA	HTiN	HN (µk10)			
0.8	2	0	733P-0.8	■	■	■													
1.0	2	0	733P-1.0	■	■	■													
1.2	2.5	0	733P-1.2	■	■	■													
1.5	3	0	733P-1.5	■	■	■													

7XX-XX-B



Sur demande pour serrage type B, voir page 1.03
 Wahlweise mit B-Spannsystem, siehe Seite 1.03
 On request for B clamping system, see page 1.03

■ = disponible / verfügbar / available
 □ = selon disponibilité du stock / jenach Lagerverfügbarkeit / depending on stock availability

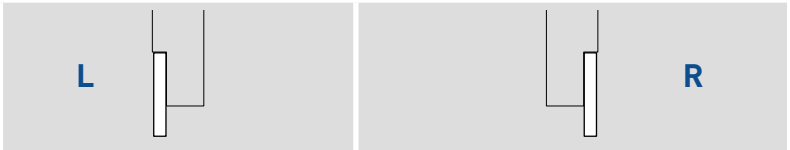
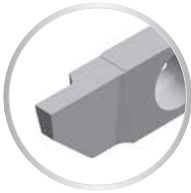
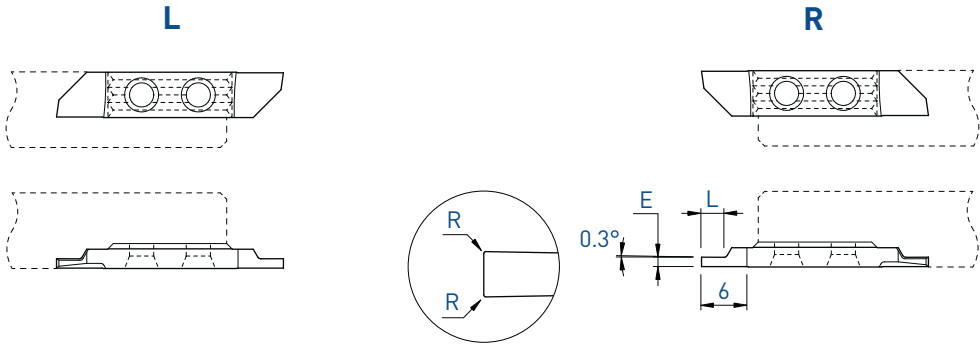

E	L	R	Art. N°	TiAlN	TiN	N (µk20)	HTA	HTiN	HN (µk10)	Art. N°	TiAlN	TiAlX	TiN	N (µk20)	HTA	HTAX	HTiN	HN (µk10)
0.5	1.5	0	734-0.5	■	■	■	■	□	■	744-0.5	■	■	■	■	■	■	■	■
0.6	1.8	0	734-0.6	■	■	■	■	□	■	744-0.6	■	■	■	■	■	■	□	■
0.75	2	0	734-0.75	■	■	■	■	■	■	744-0.75	■	■	■	■	■	■	■	■
0.8	2	0	734-0.8	■	■	■	■	□	■	744-0.8	■	■	■	■	■	■	□	■
0.8	2	0.08	-							744-0.8-R08	■	■	■	■	■	■	□	■
0.9	2.5	0	-							744-0.9	■	■	■	■	■	■	□	■
0.95	3	0	734-0.95	■	■	■	■	■	■	744-0.95	■	■	■	■	■	■	□	■
1.0	2.5	0	734-1.0	■	■	■	■	■	■	744-1.0	■	■	■	■	■	■	■	■
1.0	2.5	0.08	734-1.0-R08	■	■	■	■	■	■	744-1.0-R08	■	■	■	■	■	■	□	■
1.2	3	0	734-1.2	■	■	■	■	□	■	744-1.2	■	■	■	■	■	■	■	■
1.5	3	0	734-1.5	■	■	■	■	■	■	744-1.5	■	■	■	■	■	■	■	■
1.5	3	0.08	734-1.5-R08	■	■	■	■	□	■	744-1.5-R08	■	■	■	■	■	■	□	■
1.5	3	0.15	-							744-1.5-R15	■	■	□	■	■	■	□	■
1.5	3	0.20	-							744-1.5-R20	■	■	■	■	■	■	□	■
1.8	4	0	734-1.8	■	■	■	■	□	■	744-1.8	■	■	■	■	■	■	□	■
2.0	4	0	734-2.0	■	■	■	■	□	■	744-2.0	■	■	■	■	■	■	□	■
2.0	4	0.08	734-2.0-R08	■	■	■	■	□	■	744-2.0-R08	■	■	■	■	■	■	□	■
2.0	4	0.15	-							744-2.0-R15	■	■	□	■	■	■	□	■
2.0	4	0.20	-							744-2.0-R20	■	■	■	■	■	■	□	■
2.5	6	0	734-2.5	■	■	■	■	■	■	744-2.5	■	■	■	■	■	■	□	■

7XX-XX-B



Sur demande pour serrage type B, voir page 1.03
Wahlweise mit B-Spannsystem, siehe Seite 1.03
On request for B clamping system, see page 1.03

Fonçage-tournage

Einstecken und drehen

Grooving and turning

734VS / 744VS

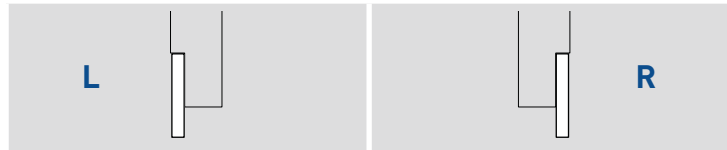
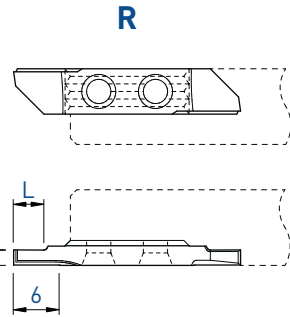
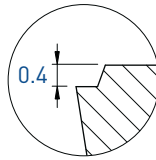
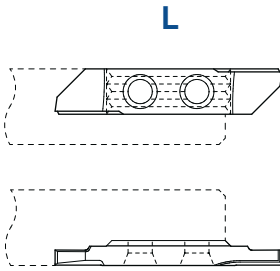

L			R												
E	L	Art. N°	TiAlN	TiN	N (µk20)	HTA	HTiN	HN (µk10)	Art. N°	TiAlN	TiN	N (µk20)	HTA	HTiN	HN (µk10)
1.0	2	734VS-1.0	■	■	■	■	□	■	744VS-1.0	■	■	■	■	□	■
1.2	2.5	734VS-1.2	■	■	■	■	□	■	744VS-1.2	■	■	■	■	□	■
1.5	3	734VS-1.5	■	■	■	■	□	■	744VS-1.5	■	■	■	■	□	■
1.8	4	734VS-1.8	■	■	■				744VS-1.8	■	■	■			
2.0	4	734VS-2.0	■	■	■				744VS-2.0	■	■	■	■	□	■
2.5	6	734VS-2.5	■	■	■				744VS-2.5	■	■	■			

7XX-XX-B



Sur demande pour serrage type B, voir page 1.03
Wahlweise mit B-Spannsystem, siehe Seite 1.03
On request for B clamping system, see page 1.03

■ = disponible / verfügbar / available
□ = selon disponibilité du stock / jenach Lagerverfügbarkeit / depending on stock availability

TOP-LINE

Fonçage-tournage
Einstecken und drehen
Grooving and turning

734X / 744X

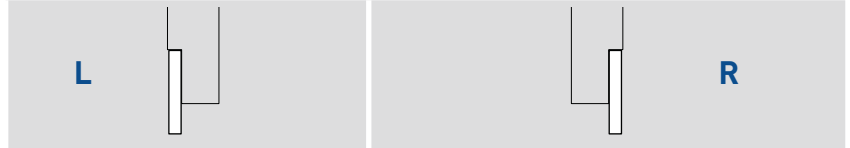
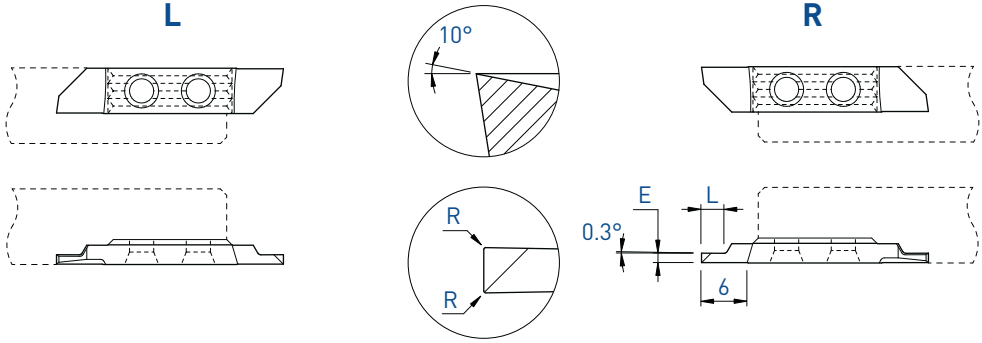

			L					R											
E	L	R	Art. N°	TiAlN	TiN	N (µk20)	HTA	HTIN	HN (µk10)	Art. N°	TiAlN	TiAlX	LOX	TiN	N (µk20)	HTA	HTAX	HTIN	HN (µk10)
0.8	2	0	734X-0.8	■	■	■	■	□	■	744X-0.8	■	■		■	■	■	■	■	■
1.0	2.5	0	734X-1.0	■	■	■	■	□	■	744X-1.0	■			■	■	■	■	■	■
1.0	2.5	0.08	734X-1.0-R08	■	■	■	■	□	■	744X-1.0-R08	■	■	■	■	■	■	■	□	■
1.2	3	0	734X-1.2	■	■	■	■	□	■	744X-1.2	■			■	■	■	■	□	■
1.5	3	0	734X-1.5	■	■	■	■	■	■	744X-1.5	■			■	■	■	■	■	■
1.5	3	0.08	734X-1.5-R08	■	■	■	■	□	■	744X-1.5-R08	■	■	■	■	■	■	■	□	■
1.5	3	0.15	-							744X-1.5-R15	■	■	■	□	■	■	■	□	■
1.5	3	0.20	-							744X-1.5-R20	■	■	■	■	■	■	■	□	■
1.8	4	0	734X-1.8	■	■	■				744X-1.8	■			■	■	■	■	□	■
2.0	4	0	734X-2.0	■	■	■	■	□	■	744X-2.0	■			■	■	■	■	■	■
2.0	4	0.08	734X-2.0-R08	■	■	■	■	□	■	744X-2.0-R08	■	■	■	■	■	■	■	■	■
2.0	4	0.15	-							744X-2.0-R15	■	■	■	□	■	■	■	□	■
2.0	4	0.20	734X-2.0-R20	■	■	■	■	□	■	744X-2.0-R20	■	■	■	■	■	■	■	□	■
2.5	6	0	734X-2.5	■	■	■	■	□	■	744X-2.5	■	■		■	■	■	■	□	■

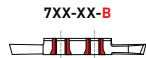

7XX-XX-B Sur demande pour serrage type B, voir page 1.03
Wahlweise mit B-Spannsystem, siehe Seite 1.03
On request for B clamping system, see page 1.03

Fonçage-tournage

Einstecken und drehen

Grooving and turning

734ZX / 744ZX

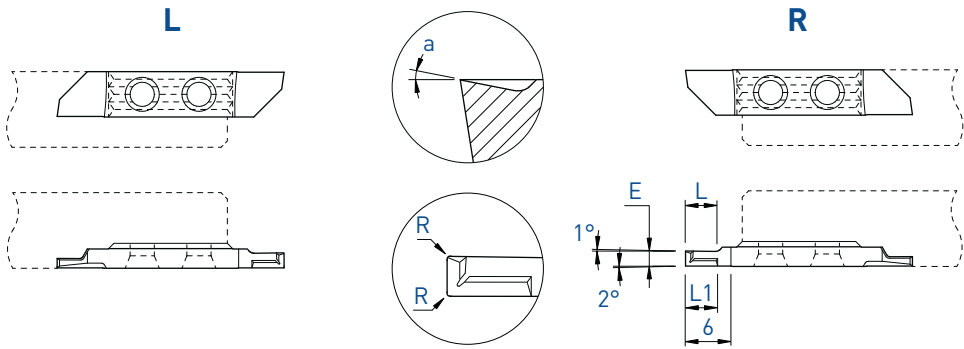

Pour un meilleur contrôle des copeaux
Für eine bessere Spankontrolle
For a better chip-control



a	E	L	L1	R	Art. N°	TiAlN				Art. N°	TiAlN					
						TiN	TiN	N (µk20)	HTA		HAS	HTiN	HN (µk10)	TiAlN	TiAlX	TiN
10°	1.0	2.5	3	0.01	734ZX10-1.0	■	■			744ZX10-1.0	■	■	■	■		□
	1.5	4	4	0.01	734ZX10-1.5	■	■			744ZX10-1.5	■	■	□	■		■
	1.5	4	4	0.08	734ZX10-1.5-R08	■	■			744ZX10-1.5-R08	■	■	■	■		
	2.0	4	4	0.01	734ZX10-2.0	■	■			744ZX10-2.0	■	■	□	■		□
	2.0	4	4	0.08	734ZX10-2.0-R08	■	■			744ZX10-2.0-R08	■	■	□	■		
	2.5	6	4	0.01	734ZX10-2.5	■	■			744ZX10-2.5	■	■	□	■		□
	2.5	6	4	0.08	-					744ZX10-2.5-R08	■	■	□	■		
17°	1.0	2.5	3	0.01	-					744ZX17-1.0				■	■	

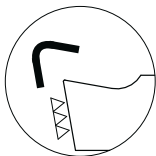

Arête de coupe honée
Gehonte Schneidkante
Honed edge

f min: 0.02 mm/U

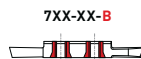

7XX-XX-B
Sur demande pour serrage type B, voir page 1.03
Wahlweise mit B-Spannsystem, siehe Seite 1.03
On request for B clamping system, see page 1.03

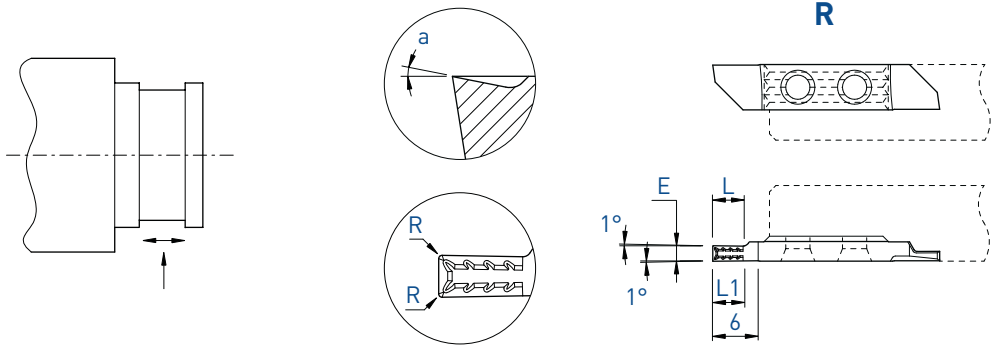

Pour un meilleur contrôle des copeaux
Für eine bessere Spankontrolle
For a better chip-control

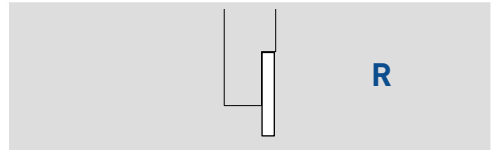

a	E	L	L1	R	Art. N°	TiAIN	TiAlX	LOX	TiN	N (µk20)	HTA	HTiN	HN (µk10)
10°	1.0	2.5	2.5	0.01	744ZXT10-1.0	■	■	■	■		■	□	
	1.5	4	4	0.01	744ZXT10-1.5	■	■	■	□		■	□	
	1.5	4	4	0.08	744ZXT10-1.5-R08	■	■	■	■		■	□	
	2.0	4	4	0.01	744ZXT10-2.0	■	■	■	□		■	□	
	2.0	4	4	0.08	744ZXT10-2.0-R08	■	■	■	□		■	□	
	2.5	5	5	0.01	744ZXT10-2.5	■	■	■	□		■	□	
	2.5	5	5	0.08	744ZXT10-2.5-R08	■	■	■	□		■	□	

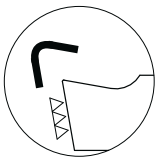

Arête de coupe honée
Gehonte Schneidkante
Honed edge

f min: 0.02 mm/U



7XX-XX-B

Sur demande pour serrage type B, voir page 1.03
Wahlweise mit B-Spannsystem, siehe Seite 1.03
On request for B clamping system, see page 1.03

Gorges
Einstechen
Grooving

735 / 745

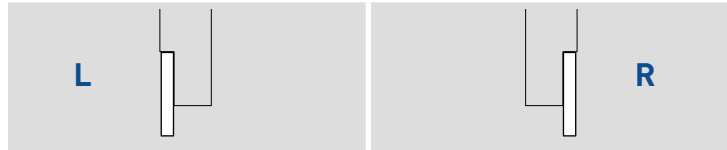
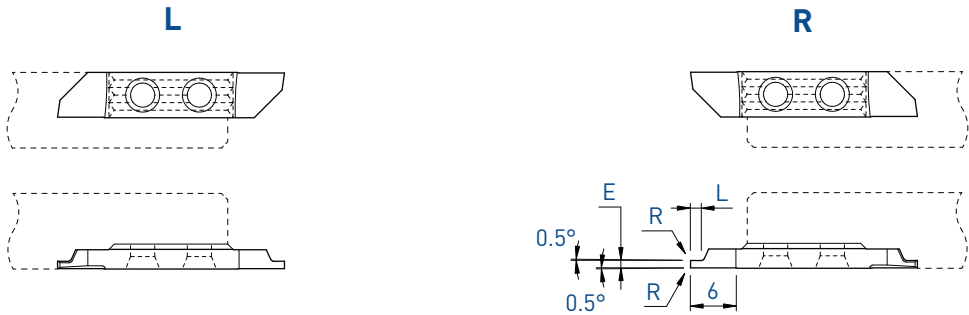

E ± 0.01			Art. N°	TiAlN	TiN	N (µk20)	HTA	HTiN	HN (µk10)	Art. N°	TiAlN	TiN	N (µk20)	HTA	HTiN	HN (µk10)
	L	R														
0.2	0.2	0	735-0202	■	■	■				745-0202	■	■	■	■	□	■
0.3	0.3	0	735-0303	■	■	■				745-0303	■	■	■	■	□	■
0.4	0.4	0	735-0404	■	■	■				745-0404	■	□	■	■	□	■

7XX-XX-B



Sur demande pour serrage type B, voir page 1.03
Wahlweise mit B-Spannsystem, siehe Seite 1.03
On request for B clamping system, see page 1.03

■ = disponible / verfügbar / available
□ = selon disponibilité du stock / jenach Lagerverfügbarkeit / depending on stock availability

TOP-LINE

Gorges
Einstecken
Grooving

735X-90 / 745X-90

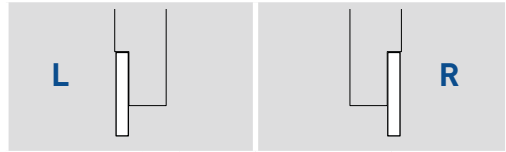
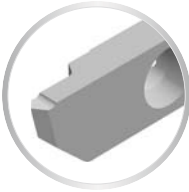
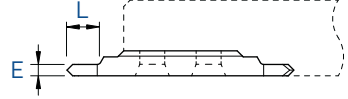
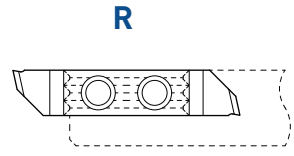
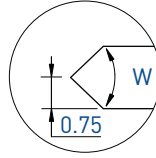
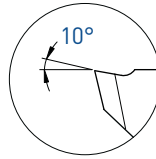
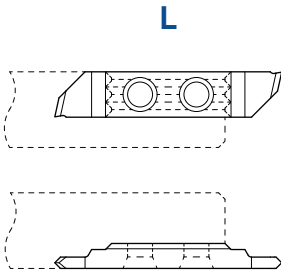

W	E	L	Art. N°	TiAIN	TiN	N (μk20)	Art. N°	TiAIN	TiN	N (μk20)
90°	1.5	4	735X-90-1.5	□	□	□	745X-90-1.5	■	□	■

7XX-XX-B



Sur demande pour serrage type B, voir page 1.03
Wahlweise mit B-Spannsystem, siehe Seite 1.03
On request for B clamping system, see page 1.03

Filetage

Gewinde drehen

Threading

736 / 746

L

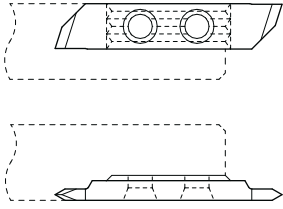

R

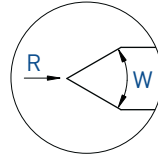
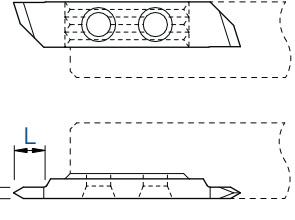

Profil partiel
Teilprofil
Partial profile



W	E	L	R	L						R								
				Art. N°	TiAlN	TiN	N (µk20)	HTA	HTiN	HN (µk10)	Art. N°	TiAlN	TiN	N (µk20)	HTA	HTiN	HN (µk10)	
60°	1.5	4	0	736-60-1.5	■	■	■					746-60-1.5	■	■	■			
60°	1.5	4	0.02	736-60-1.5-R02	■	■	■		■	■	■	746-60-1.5-R02	■	■	■		□	■
60°	2.0	6	0	736-60-2.0	■	■	■					746-60-2.0	■	■	■			
60°	2.0	6	0.02	736-60-2.0-R02	■	■	■		■	■	■	746-60-2.0-R02	■	■	■			■
55°	1.5	4	0	736-55-1.5	■	■	■					746-55-1.5	■	■	■			
55°	1.5	4	0.02	736-55-1.5-R02	■	■	■					746-55-1.5-R02	■	■	■			
55°	2.0	6	0	736-55-2.0	■	■	■					746-55-2.0	■	■	■			
55°	2.0	6	0.02	736-55-2.0-R02	■	■	■					746-55-2.0-R02	■	■	■			

7XX-XX-B



Sur demande pour serrage type B, voir page 1.03
Wahlweise mit B-Spannsystem, siehe Seite 1.03
On request for B clamping system, see page 1.03

■ = disponible / verfügbar / available
□ = selon disponibilité du stock / jenach Lagerverfügbarkeit / depending on stock availability

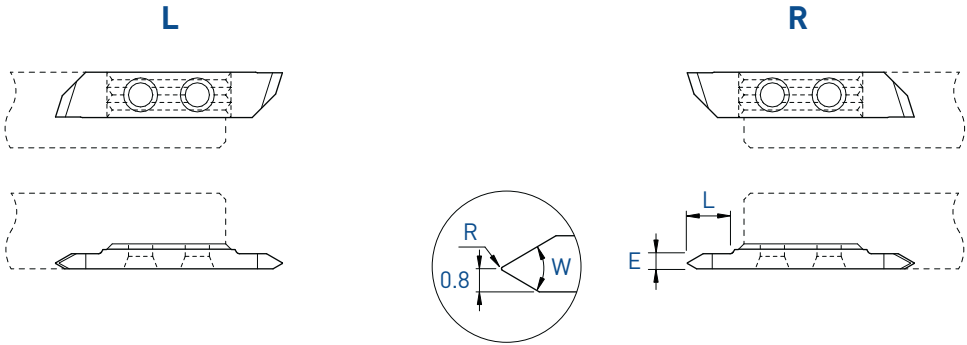

Profil partiel
Teilprofil
Partial profile

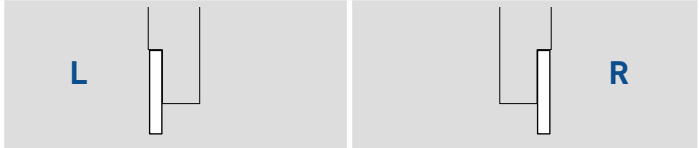

W	E	L	R	Pas steigung Pitch P	Art. N°	TiAlN	TiN	N (µk20)	HTA	HTiN	HN (µk10)	Art. N°	TiAlN	TiN	N (µk20)	HTA	HTiN	HN (µk10)
60°	2.0	6	0.06	0.50-1.50	736-A60°	■	■	■				746-A60°	■	■	■	■	□	■

Plaquettes de filetage avec coupe positive 2°, voir page 1.126
WSP Gewindedrehen mit positivem Schnitt 2°, siehe Seite 1.126
Threading inserts with positive cut 2°, see page 1.126

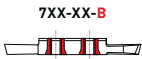

Sur demande pour serrage type B, voir page 1.03
Wahlweise mit B-Spannsystem, siehe Seite 1.03
On request for B clamping system, see page 1.03

Filetage

Gewinde drehen

Threading

736-M / 746-M

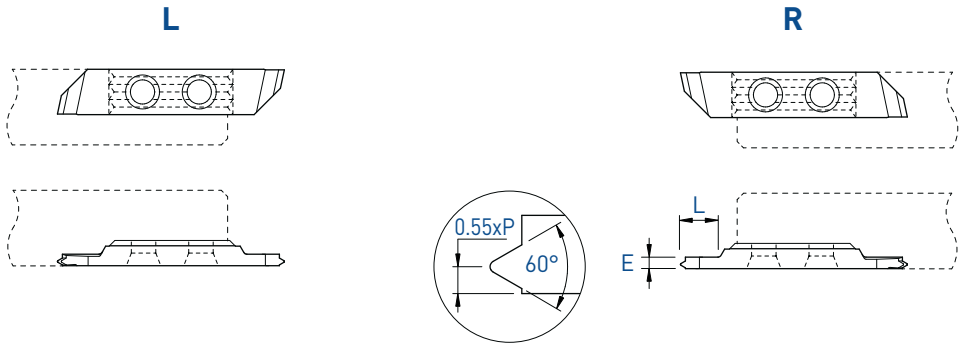

Profil complet métrique
Metrisches Vollprofil
Metric full profile

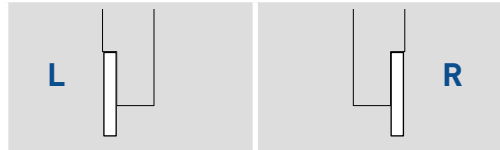

Pas steigung Pitch P	E	L	L			R				
			Art. N°	TiAIN	TiN	N (µm20)	Art. N°	TiAIN	TiN	N (µm20)
0.25	1.0	3	736-M-0.25	■	■	■	746-M-0.25	■	■	■
0.30	1.0	3	736-M-0.30	■	■	■	746-M-0.30	■	■	■
0.35	1.0	3	736-M-0.35	■	■	■	746-M-0.35	■	■	■
0.40	1.0	3	736-M-0.40	■	■	■	746-M-0.40	■	■	■
0.45	1.0	3	736-M-0.45	■	■	■	746-M-0.45	■	■	■
0.50	1.0	3	736-M-0.50	■	■	■	746-M-0.50	■	■	■
0.60	1.0	3	736-M-0.60	■	■	■	746-M-0.60	■	■	■
0.70	1.0	3	736-M-0.70	■	■	■	746-M-0.70	■	■	■
0.75	1.0	3	736-M-0.75	■	■	■	746-M-0.75	■	■	■
0.80	1.5	4.5	736-M-0.80	■	■	■	746-M-0.80	■	■	■
1.00	1.5	4.5	736-M-1.00	■	■	■	746-M-1.00	■	■	■
1.25	1.5	4.5	736-M-1.25	■	■	■	746-M-1.25	■	■	■
1.50	2.0	6	736-M-1.50	■	■	■	746-M-1.50	■	■	■
1.75	2.0	6	736-M-1.75	■	■	■	746-M-1.75	■	■	■

Plaquettes de filetage avec coupe positive 2°, voir page 1.127
WSP Gewindedrehen mit positivem Schnitt 2°, siehe Seite 1.127
Threading inserts with positive cut 2°, see page 1.127

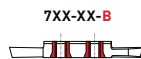

Sur demande pour serrage type B, voir page 1.03
Wahlweise mit B-Spannsystem, siehe Seite 1.03
On request for B clamping system, see page 1.03

■ = disponible / verfügbar / available
□ = selon disponibilité du stock / jenach Lagerverfügbarkeit / depending on stock availability

L

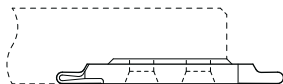
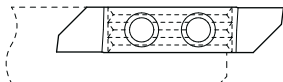

R

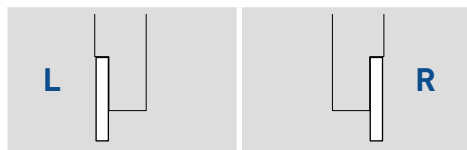
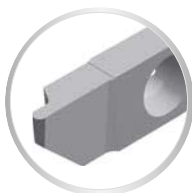
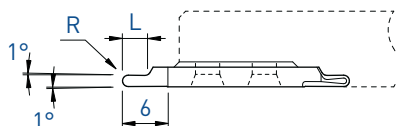
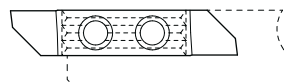

R	L	Art. N°	TiAlN			Art. N°	TiN		
			TiAlN	TiN	N (μm20)		TiAlN	TiN	N (μm20)
0.25	1.5	-				747-R0.25	■	■	■
0.40	2	-				747-R0.4	■	■	■
0.50	2.5	737-R0.5	■	■	■	747-R0.5	■	■	■
0.60	2.5	737-R0.6	■	■	■	747-R0.6	■	■	■
0.75	3	737-R0.75	■	■	■	747-R0.75	■	■	■
0.80	3	737-R0.8	■	■	■	747-R0.8	■	■	■
1.00	4	737-R1.0	■	■	■	747-R1.0	■	■	■

7XX-XX-B



Sur demande pour serrage type B, voir page 1.03
 Wahlweise mit B-Spannsystem, siehe Seite 1.03
 On request for B clamping system, see page 1.03

Plaquettes ébauches
WSP-Rohlinge
Blank inserts

731-E / 741-E
731-EP / 741-EP

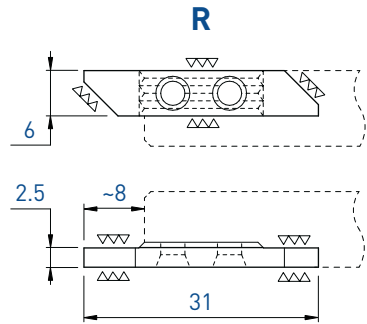
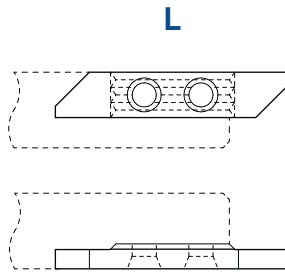
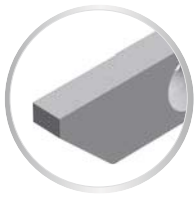

L			R		
Art. N°	N (µk20)	HN (µk10)	Art. N°	N (µk20)	HN (µk10)
731-E	■	■	741-E	■	■



Face de coupe polie
Polierte Schneidfläche
Polished cutting face

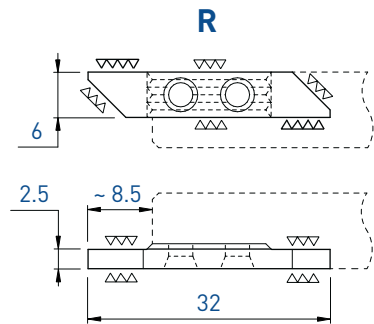
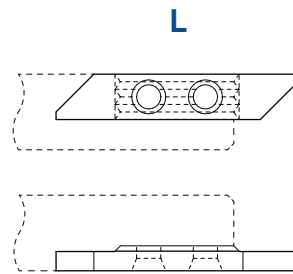

L						R							
Art. N°	TiAlN	TiN	N (µk20)	HTA	HTiN	HN (µk10)	Art. N°	TiAlN	TiN	N (µk20)	HTA	HTiN	HN (µk10)
731-EP	■	■	■	■	■	■	741-EP	■	■	■	■	□	■

7XX-XX-B



Sur demande pour serrage type B,
voir page 1.03
Wahlweise mit B-Spannsystem,
siehe Seite 1.03
On request for B clamping system,
see page 1.03

■ = disponible / verfügbar / available
□ = selon disponibilité du stock / jenach Lagerverfügbarkeit / depending on stock availability

L			R		
Type		Page	Type		Page
750	750	1.70	760	760	1.70
	750-JET	1.71		760/750-D	1.75/ 1.76
	750RC	1.72		760/750-AX	1.77
751	751	1.78	760-JET	1.71	
	751-E	1.128	760LC	1.73	
	751-EP	1.128	760-NOVIBRA	1.74	
	751NXF	1.87/ 1.97	761	761	1.78
	751R	1.88	761-E	1.128	
	751-R05	1.80	761-EP	1.128	
	751RAS	1.99	761L	1.88	
	751RD	1.98	761LD	1.98	
	751R-R05	1.90	761L-R05	1.90	
	751RS	1.89	761LS	1.89	
	751RU	1.95	761LX12	1.93	
	751RZU	1.96	761LX25	1.94	
	751RX12	1.93	761LX4	1.91	
	751RX25	1.94	761LXF	1.92	
	751RX4	1.91	761NXF	1.87/ 1.97	
	751RXF	1.92	761-R05	1.80	
	751S	1.79	761S	1.79	
	751U	1.85	761U	1.85	
	751X12	1.83	761ZU	1.86	
	751X25	1.84	761X12	1.83	
	751X4	1.81	761X25	1.84	
751XF	1.82	761X4	1.81		
752	752	1.100	761XF	1.82	
	752PX	1.101	762	762	1.100
	752S05	1.105	762PX	1.101	
753	752X	1.102	762S05	1.105	
	753	1.106	762X	1.102	
	753P	1.116	762VX-800	1.103	
	753S05	1.105	762ZX	1.104	
	753VX-15°	1.112	763	763	1.106
	753VX-8°	1.109	763P	1.116	
	753VX-805	1.110	763S05	1.105	
	753X	1.107	763VUX	1.114	
	753XS	1.108	763VX-15°	1.112	
	753ZX10	1.115	763VX-8°	1.109	
	754	754	1.117	763VX-800	1.111
		754VS	1.118	763VX-805	1.110
		754X	1.119	763X	1.107
		754ZX10	1.122	763XS	1.108
756	754ZXT	1.124	763ZX10	1.115	
	756-55	1.125	764	764	1.117
	756-60	1.125	764VS	1.118	
	756-AG60°	1.126	764X	1.119	
757	756-G60°	1.126	764X5	1.120	
	756-M	1.127	764X10	1.121	
	757	1.128	764ZX10	1.122	
	757ZX	1.129	764ZX25	1.122	
			764ZXB	1.123	
			764ZXT	1.124	
			766	766-55	1.125
				766-60	1.125
				766-AG60°	1.126
				766-G60°	1.126
				766-M	1.127
			767	767	1.128
				767ZX	1.129

	<p>751 / 761 Tronçonnage Abstechen Parting off</p>		<p>750 / 760 Porte-outils Halter Holders</p>	<p>> 1.70</p>
	<p>752 / 762 Tournage avant Vorwärts drehen Front turning</p>		<p>761L / 751R Tronçonnage - coupe déportée Abstechen - versetztes Schneiden Parting off - cut off line</p>	<p>> 1.78</p>
	<p>754 / 764 Fonçage-tournage Einstecken und drehen Grooving and turning</p>		<p>753 / 763 Tournage arrière Rückwärts drehen Back turning</p>	<p>> 1.100</p>
	<p>757 / 767 Plaquettes à rayon Radius Wendeplatten Radius inserts</p>		<p>756 / 766 Filetage Gewinde drehen Threading</p>	<p>> 1.106</p>
	<p>Plaquettes ébauches WSP-Rohlinge Blank inserts</p>	<p>> 1.125</p>	<p>> 1.128</p>	
	<p>Plaquettes ébauches WSP-Rohlinge Blank inserts</p>	<p>> 1.130</p>		

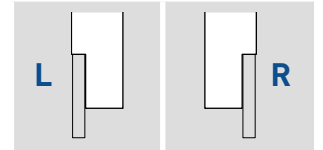
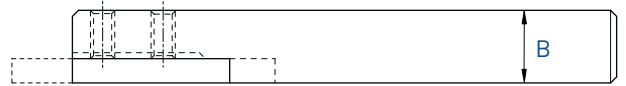
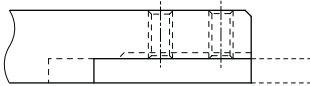
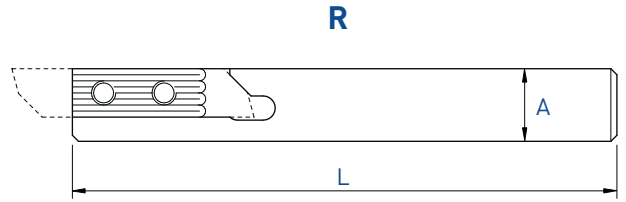
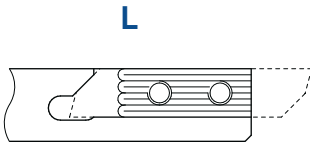

Serrage standard A
Standard Spannsystem A
Standard clamping system A

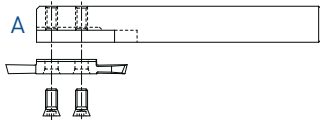

A x B	L	Serrage Spannsystem Clamping	Art. N°	Art. N°
10 x 10	115	A	750-10	760-10
10 x 10	115	A + B	750-10-AB	760-10-AB
10 x 10	50	A	750-10-50	760-10-50
12 x 12	130	A	750-12	760-12
12 x 12	130	A + B	750-12-AB	760-12-AB
12 x 12	90	A	750-12-90	760-12-90
12 x 12	90	A + B	750-12-90-AB	760-12-90-AB
12.7 x 12.7	130	A + B	750-12.7	760-12.7
14 x 14	130	A + B	750-14	760-14
16 x 16	130	A + B	750-16	760-16
16 x 16	75	A + B	750-16-75	760-16-75
20 x 20	120	A + B	750-20	760-20
25 x 25	140	A	760/750-25	

Serrage A + B
Spannsystem A + B
Clamping system A + B

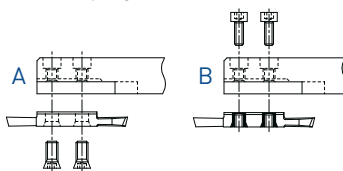

760/750-25
R + L



Chaque support est livré avec vis et clé.
Jeder Halter wird mit Spannschraube(n) und Schlüssel geliefert.
Screw(s) and key are included with each tool holder.

Porte-outils avec arrosage intégré
 Halter mit integrierter Kühlmittelzufuhr
 Holders with integrated coolant supply

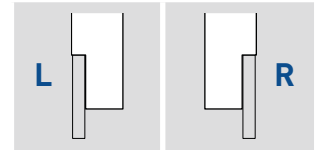
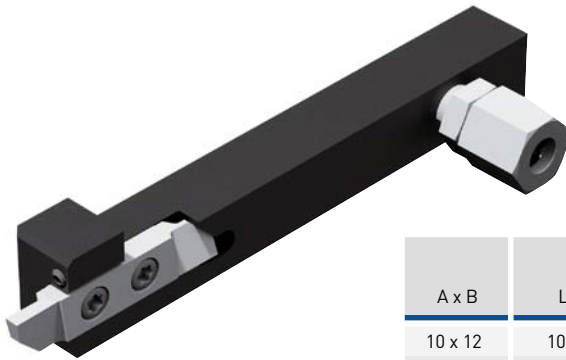
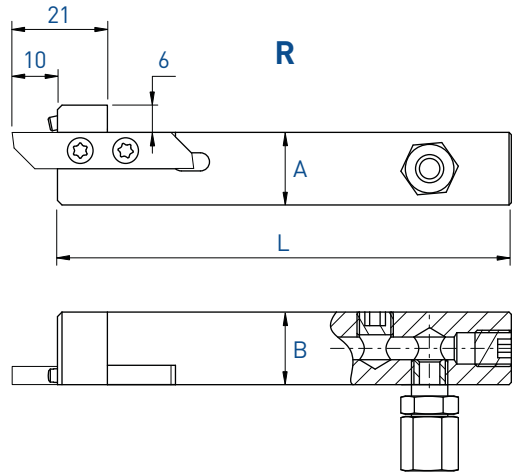
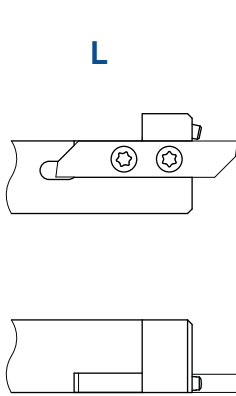

750-JET / 760-JET



A x B	L	Serrage Spannsystem Clamping	Art. N°	Art. N°
10 x 12	100	A + B	750-1012-JET	760-1012-JET
12 x 12	100	A + B	750-12-JET	760-12-JET
12.7 x 12.7	100	A + B	750-12.7-JET	760-12.7-JET
16 x 16	100	A + B	750-16-JET	760-16-JET
20 x 20	100	A + B	750-20-JET	760-20-JET

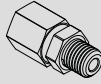

Chaque support est livré avec vis et clé.
 Jeder Halter wird mit Spannschraube(n)
 und Schlüssel geliefert.
 Screw(s) and key are included with each
 tool holder.

Pièces de rechange Ersatzteile Spare parts			Buse Düse Nozzle 
	Art. N°	Art. N°	Art. N°
750-JET / 760-JET	J-M8X1-D6	JB-M8X1	JJ-M3X6-D1.5

Porte-outils
Halter
Holder

Coupe à droite déportée
Versetztes Rechtsschneiden
Right cut off line

750RC

Utiliser des plaquettes type 751R
 WSP Typ 751R verwenden
 Use inserts type 751R

Voir pages 1.88 - 1.99
 Siehe Seiten 1.88 - 1.99
 See pages 1.88 - 1.99

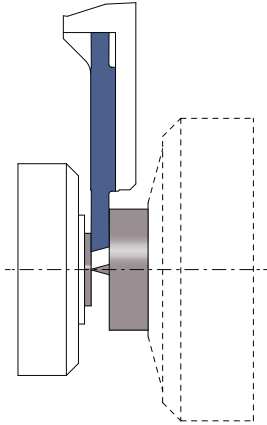
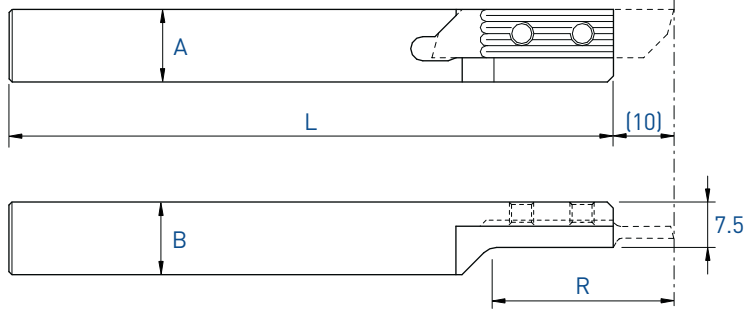

L (R)			
Coupe à droite déportée Versetztes Rechtsschneiden Right cut off line			
A x B	R	L	Art. N°
12 x 12	30	130	750RC-12
16 x 16	40	130	750RC-16

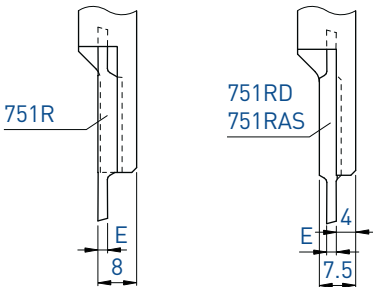

(p. 1.98 - 1.99)



Chaque support est livré avec vis et clé.
 Jeder Halter wird mit Spanschraube(n) und Schlüssel geliefert.
 Screw(s) and key are included with each tool holder.

Porte-outils

Halter

Holder

Coupe à gauche déportée

Versetztes Linksschneiden

Left cut off line

760LC

Utiliser des plaquettes type 761L
WSP Typ 761L verwenden
Use insets type 761L

Voir pages 1.88 - 1.94 + 1.98
Siehe Seiten 1.88 - 1.94 + 1.98
See pages 1.88 - 1.94 + 1.98

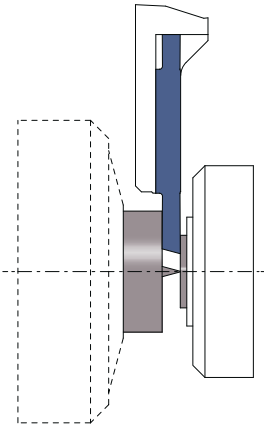
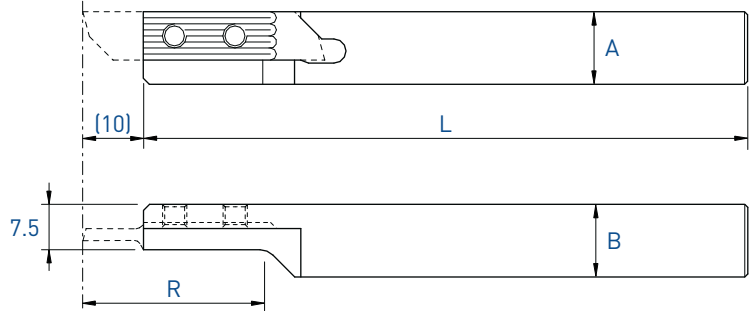

R (L)

Coupe à gauche déportée
Versetztes Linksschneiden
Left cut off line

A x B	R	L	Art. N°
16 x 16	40	130	760LC-16

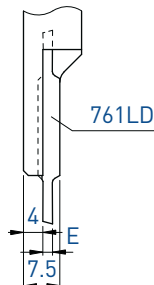
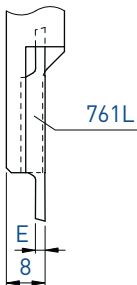

(p. 1.98)



Chaque support est livré avec vis et clé.
Jeder Halter wird mit Spannschraube(n) und Schlüssel geliefert.
Screw(s) and key are included with each tool holder.

R

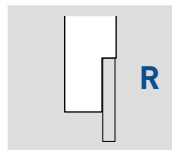
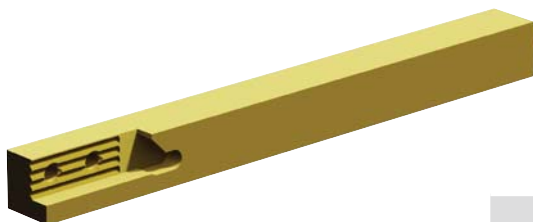
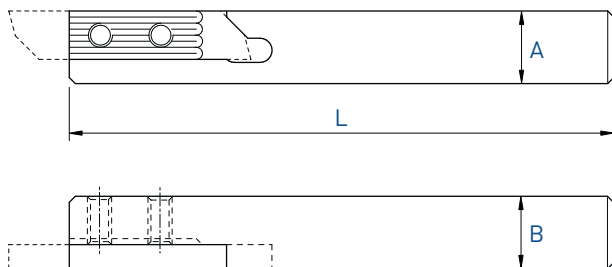

A x B	L	Serrage Spannsystem Clamping	Art. N°
10 x 10	115	A	760-10-NOVIBRA
12 x 12	130	A	760-12-NOVIBRA

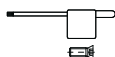

Chaque support est livré avec vis et clé.
 Jeder Halter wird mit Spannschraube(n) und Schlüssel geliefert.
 Screw(s) and key are included with each tool holder.

Porte-outils

Halter

Holders

760 / 750-D10

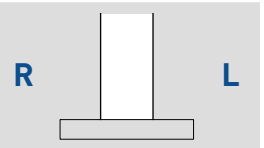
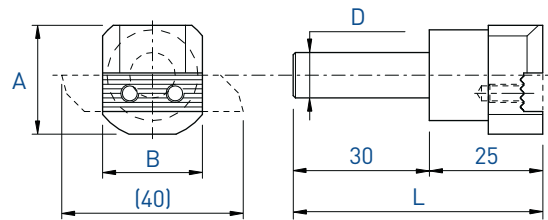

D	L	A	B	Art. N°
10	55	24	22	760/750-D10

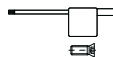

Chaque support est livré avec vis et clé.
 Jeder Halter wird mit Spannschraube(n) und Schlüssel geliefert.
 Screw(s) and key are included with each tool holder.

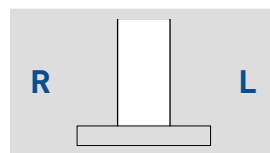
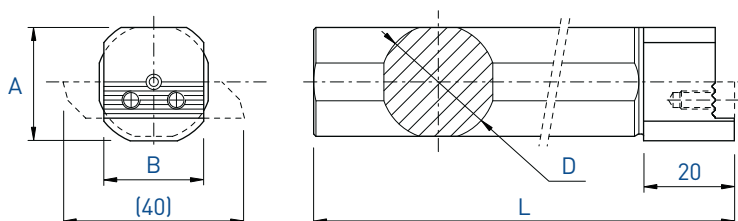

D	L	A	B	Art. N°
16	160	25	22	760/750-D16
19.05	160	25	22	760/750-D19.05
19.05	110	25	22	760/750-D19.05-S
20	160	25	22	760/750-D20
22	110	25	22	760/750-D22
25	200	25	22	760/750-D25
25.4	200	25	22	760/750-D25.4
25.4	125	25	22	760/750-D25.4-S

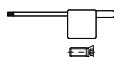

Chaque support est livré avec vis et clé.
 Jeder Halter wird mit Spannschraube(n) und Schlüssel geliefert.
 Screw(s) and key are included with each tool holder.

Porte-outils

Halter

Holders

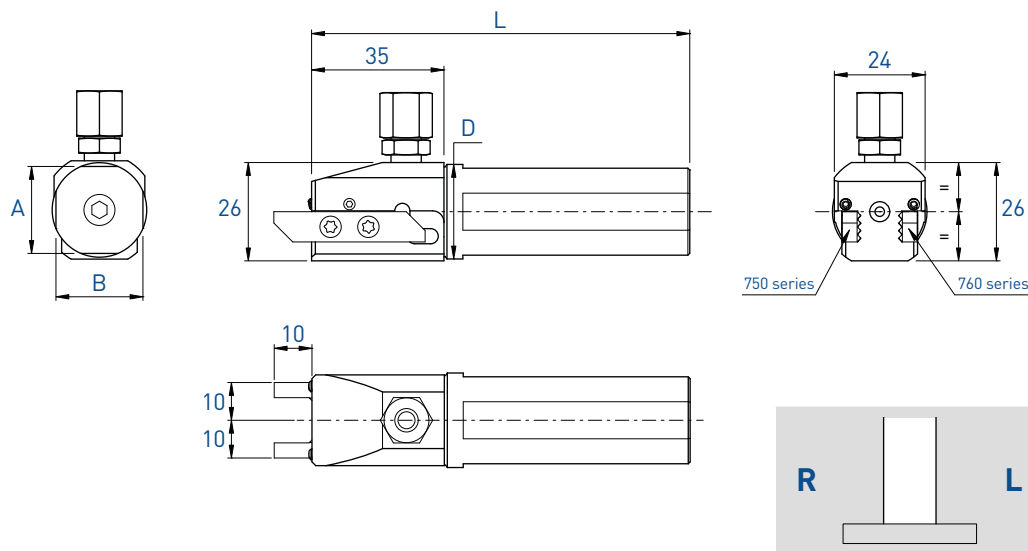

760 / 750-AX

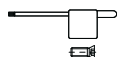

D	L	A	B	Art. N°
25	100	23	23	760/750-AX-D25-JET
25.4	100	23	23	760/750-AX-D25.4-JET

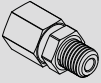

Chaque support est livré avec vis et clé.
 Jeder Halter wird mit Spannschraube(n)
 und Schlüssel geliefert.
 Screw(s) and key are included with each
 tool holder.

Pièces de rechange Ersatzteile Spare parts			Buse Düse Nozzle 
	Art. N°	Art. N°	Art. N°
760/750-AX	J-M8X1-D6	JB-M8X1	JJ-M3X6-D1.5

Tronçonnage

Abstechen

Parting off

751 / 761

L

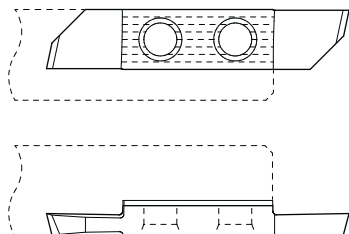

R

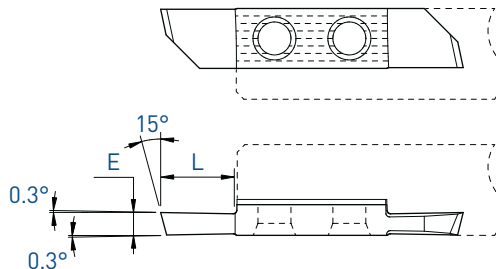

L



R



E	L	Art. N°	L			R			Art. N°	R			HTA	HTiN	HN (µk10)	
			TiAlN	TiN	N (µk20)	TiAlN	TiAlX	TiN		N (µk20)						
1.0	5	751-1.0	■	■	■	■	□	■	761-1.0	■	■	■	■	■	■	■
1.2	5	751-1.2	■	■	■	■	□	■	761-1.2	■	■	■	■	■	■	■
1.5	7.5	751-1.5	■	■	■	■	□	■	761-1.5	■	■	■	■	■	■	■
1.8	7.5	751-1.8	■	■	■	■	□	■	761-1.8	■	■	■	■	■	■	■
2.0	10	751-2.0	■	■	■	■	□	■	761-2.0	■	■	■	■	■	■	■
2.2	10	751-2.2	■	■	■	■	□	■	761-2.2	■	■	■	■	■	■	■
2.5	10	751-2.5	■	■	■	■	□	■	761-2.5	■	■	■	■	■	■	■
3.0	10	751-3.0	■	■	■	■	□	■	761-3.0	■	■	■	■	■	■	■

7XX-XX-B



Sur demande pour serrage type B, voir page 1.03
Wahlweise mit B-Spannsystem, siehe Seite 1.03
On request for B clamping system, see page 1.03

Tronçonnage
Abstechen
Parting off

751S / 761S

L

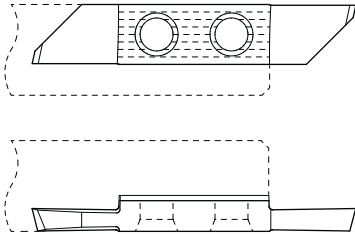

R

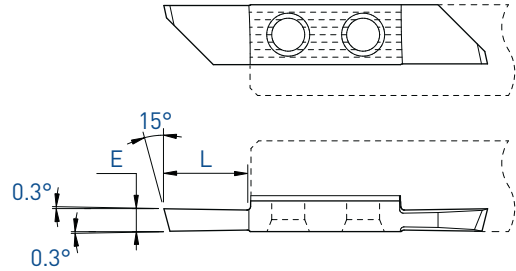

L

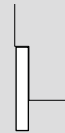

R



E	L	Art. N°	TiAlN	TiN	N (µk20)	HTA	HTiN	HN (µk10)	Art. N°	TiAlN	TiAlX	TiN	N (µk20)	HTA	HTiN	HN (µk10)
2.0	11.5	751S-2.0	■	■	■	■	□	■	761S-2.0	■	■	■	■	■	□	■
2.2	11.5	751S-2.2	■	■	■				761S-2.2	■	■	■	■	■	□	■
2.5	11.5	751S-2.5	■	■	■	■	□	■	761S-2.5	■	■	■	■	■	□	■
3.0	11.5	751S-3.0	■	■	■				761S-3.0	■	■	■	■	■	□	■

7XX-XX-B

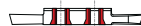

Sur demande pour serrage type B, voir page 1.03
Wahlweise mit B-Spannsystem, siehe Seite 1.03
On request for B clamping system, see page 1.03

■ = disponible / verfügbar / available
□ = selon disponibilité du stock / jenach Lagerverfügbarkeit / depending on stock availability

Tronçonnage

Abstechen

Parting off

751-R05 / 761-R05

L

R

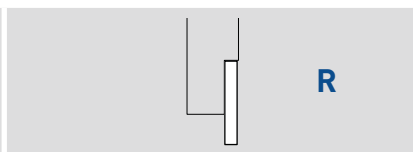
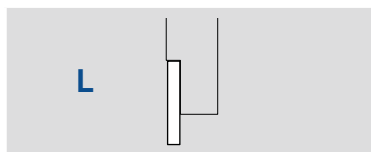
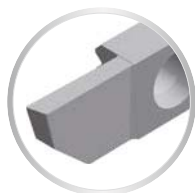
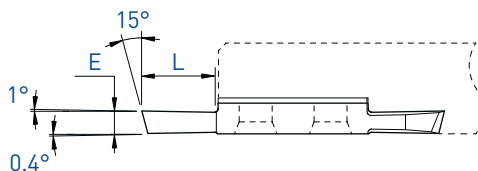
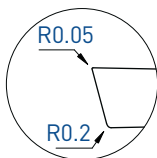
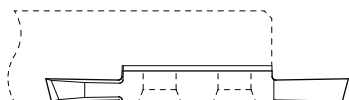
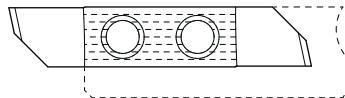
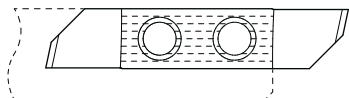

E	L	Art. N°	L			R			HTA	HTiN	HN [µk10]			
			TiAlN	TiN	N [µk20]	TiAlN	TiAlX	TiN				N [µk20]		
1.5	7.5	751-1.5-R05	■	■	■						■	□	■	
2.0	10	751-2.0-R05	■	■	■							■	□	■
2.5	10	751-2.5-R05	■	■	■									■

7XX-XX-B



Sur demande pour serrage type B, voir page 1.03
Wahlweise mit B-Spannsystem, siehe Seite 1.03
On request for B clamping system, see page 1.03

Tronçonnage
Abstechen
Parting off

751X4 / 761X4

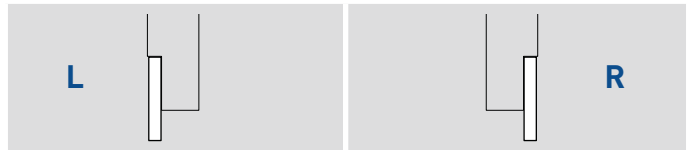
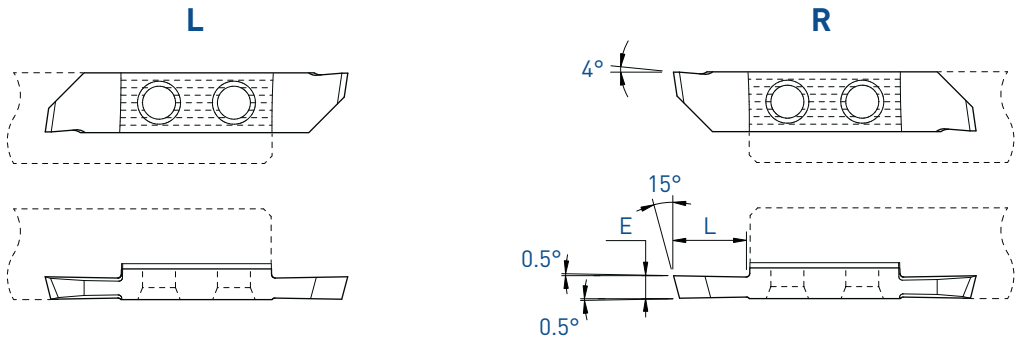

E	L	Art. N°	L			R									
			TiAlN	TiN	N (µk20)	HTA	HTiN	HN (µk10)	Art. N°	TiAlN	TiN	N (µk20)	HTA	HTiN	HN (µk10)
1.5	7.5	-							761X4-1.5	■	■	■			
2.0	10	751X4-2.0	■	■	■	■	□	■	761X4-2.0	■	■	■	■	□	■
2.5	10	-							761X4-2.5	■	■	■			

■ = disponible / verfügbar / available
□ = selon disponibilité du stock / jenach Lagerverfügbarkeit / depending on stock availability

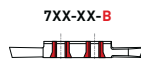

7XX-XX-B
Sur demande pour serrage type B, voir page 1.03
Wahlweise mit B-Spannsystem, siehe Seite 1.03
On request for B clamping system, see page 1.03

- Tronçonnage
- Abstechen
- Parting off

751XF / 761XF

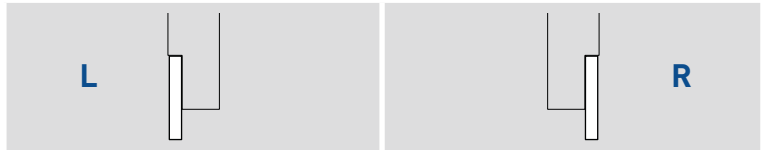
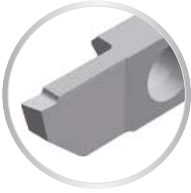
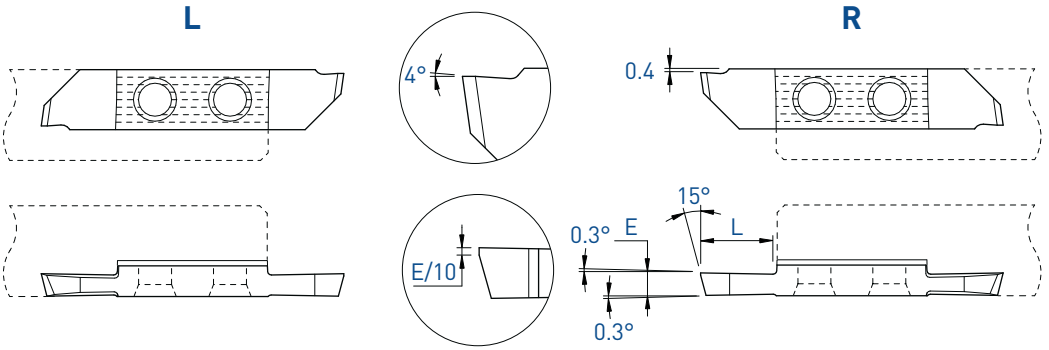

E	L	Art. N°	L			R									
			TiAlN	TiN	N (µk20)	HTA	HTiN	HN (µk10)	Art. N°	TiAlN	TiN	N (µk20)	HTA	HTiN	HN (µk10)
1.5	7.5	751XF-1.5	■	■	■	■	□	■	761XF-1.5	■	■	■	■	□	■
2.0	10	751XF-2.0	■	■	■	■	■	■	761XF-2.0	■	■	■	■	■	■
2.2	10	751XF-2.2	■	■	■				761XF-2.2	■	■	■			
2.5	10	751XF-2.5	■	■	■	■	□	■	761XF-2.5	■	■	■			
3.0	10	751XF-3.0	■	■	■				761XF-3.0	■	■	■	■	□	■

7XX-XX-B



Sur demande pour serrage type B, voir page 1.03
 Wahlweise mit B-Spannsystem, siehe Seite 1.03
 On request for B clamping system, see page 1.03

Tronçonnage

Abstechen

Parting off

751X12 / 761X12

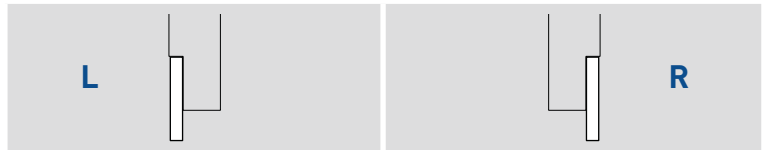
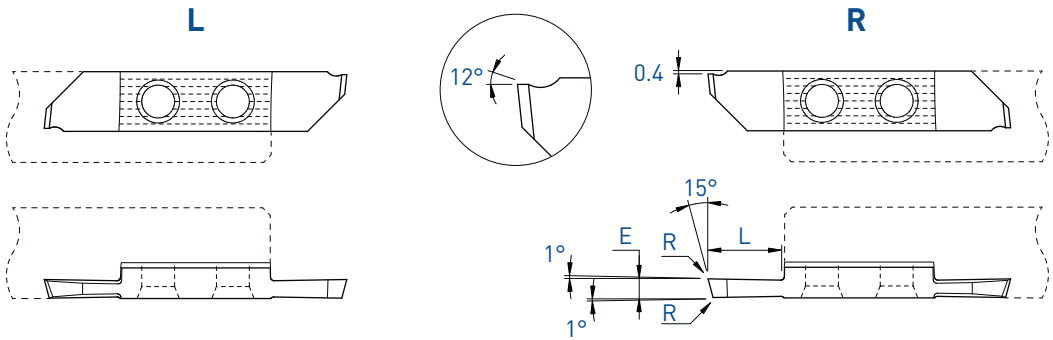

E	L	R	Art. N°	TiAlN	TiN	N (µk20)	HTA	HTiN	HN (µk10)	Art. N°	TiAlN	TiN	N (µk20)	HTA	HTiN	HN (µk10)
1.5	7.5	0.03	751X12-1.5	■	■	■	■	□	■	761X12-1.5	■	■	■	■	□	■
2.0	10	0.03	751X12-2.0	■	■	■	■	□	■	761X12-2.0	■	■	■	■	□	■
2.5	10	0.03	751X12-2.5	■	■	■	■			761X12-2.5	■	■	■	■	□	■

7XX-XX-B

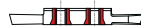

Sur demande pour serrage type B, voir page 1.03
Wahlweise mit B-Spannsystem, siehe Seite 1.03
On request for B clamping system, see page 1.03

■ = disponible / verfügbar / available
□ = selon disponibilité du stock / jenach Lagerverfügbarkeit / depending on stock availability

TOP-LINE

- Tronçonnage
- Abstechen
- Parting off

751X25 / 761X25

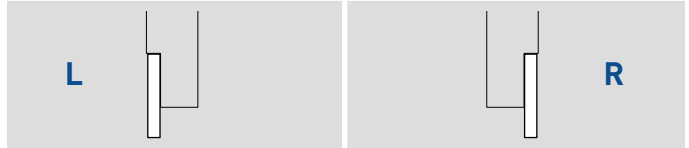
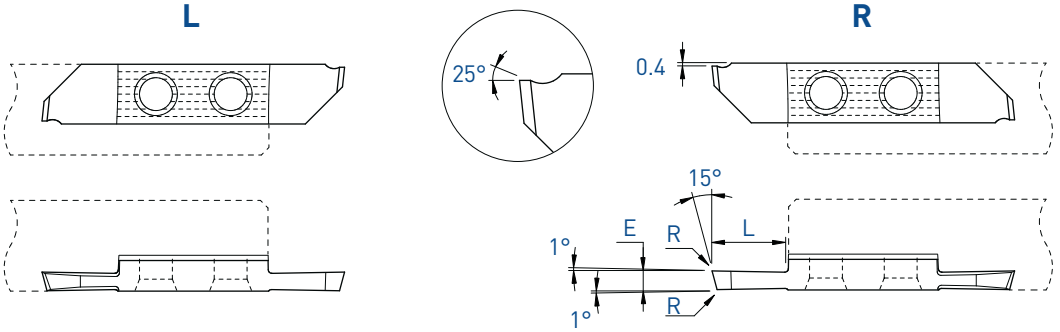

			L						R							
E	L	R	Art. N°	TiAlN	TiN	N (µk20)	HTA	HTiN	HN (µk10)	Art. N°	TiAlN	TiN	N (µk20)	HTA	HTiN	HN (µk10)
1.5	7.5	0.03	751X25-1.5	■	■	■	■	□	■	761X25-1.5	■	■	■			
2.0	10	0.03	751X25-2.0	■	■	■				761X25-2.0	■	■	■	■	□	■
2.5	10	0.03	751X25-2.5	■	■	■				761X25-2.5	■	■	■	■	□	■

7XX-XX-B



Sur demande pour serrage type B, voir page 1.03
 Wahlweise mit B-Spannsystem, siehe Seite 1.03
 On request for B clamping system, see page 1.03

Tronçonnage
Abstechen
Parting off

751U / 761U

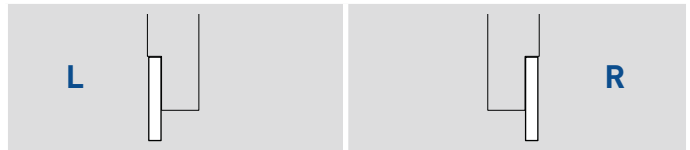
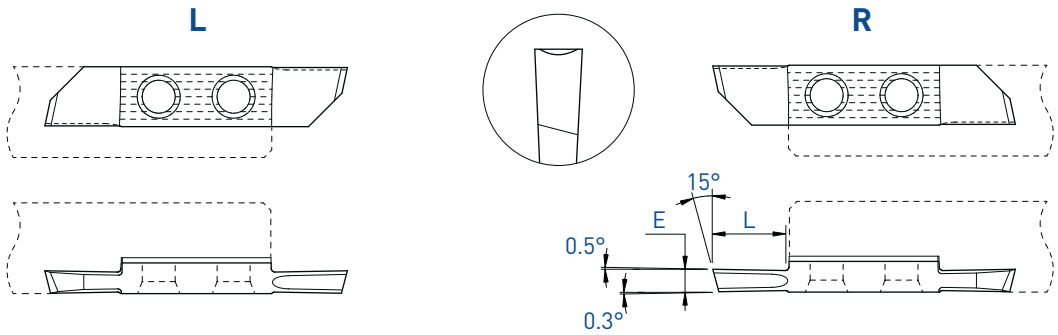

E	L	Art. N°	L			R									
			TiAlN	TiN	N (µk20)	HTA	HTiN	HN (µk10)	Art. N°	TiAlN	TiN	N (µk20)	HTA	HTiN	HN (µk10)
1.5	7.5	-							761U-1.5	■	□	■	■	□	■
2.0	10	751U-2.0	■	■	■				761U-2.0	■	■	■	□	□	■

■ = disponible / verfügbar / available
□ = selon disponibilité du stock / jenach Lagerverfügbarkeit / depending on stock availability



7XX-XX-B
Sur demande pour serrage type B, voir page 1.03
Wahlweise mit B-Spannsystem, siehe Seite 1.03
On request for B clamping system, see page 1.03

Tronçonnage

Abstechen

Parting off

761ZU

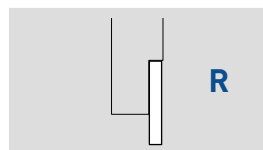
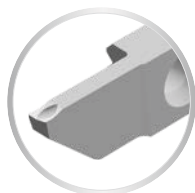
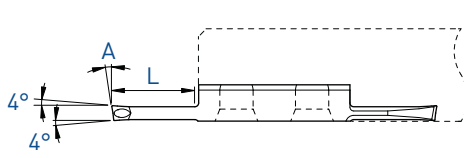
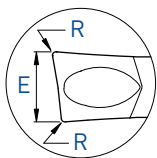
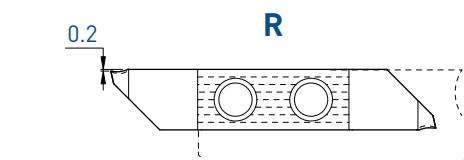
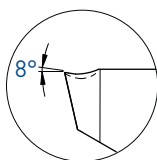

E	A	L	R	Art. N°	TiAlN N (µm20)
2.0	0°	11	0.10	761ZU8-2.0-R10	■
2.0	8°	11	0.10	761ZU8-2.0-8°-R10	■

7XX-XX-B



Sur demande pour serrage type B, voir page 1.03
Wahlweise mit B-Spannsystem, siehe Seite 1.03
On request for B clamping system, see page 1.03

Tronçonnage
Abstechen
Parting off

751NXF / 761NXF

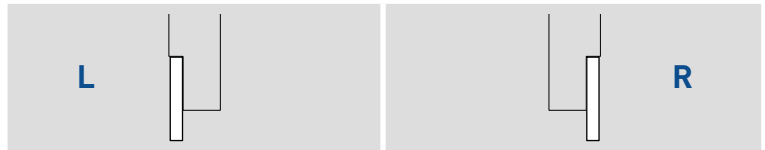
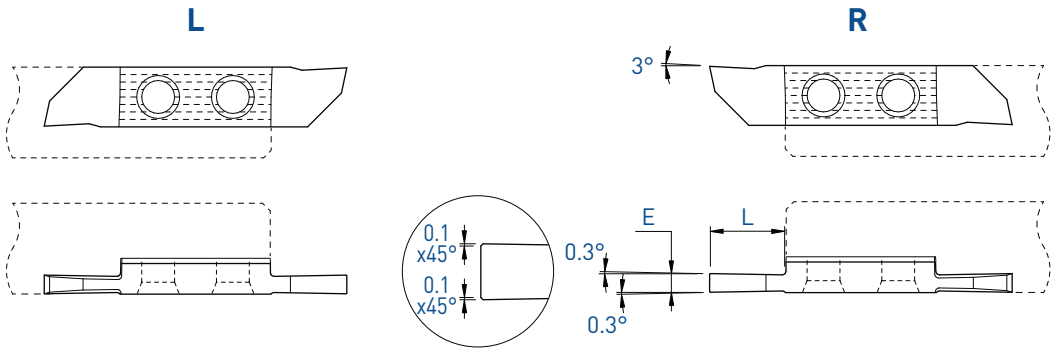

E	L	Art. N°	L			R			Art. N°	R					
			TiAlN	TiN	N (µk20)	HTA	HTiN	HN (µk10)		TiAlN	TiN	N (µk20)	HTA	HTiN	HN (µk10)
2.0	10	751NXF-2.0	■	■	■	■	□	■	761NXF-2.0	■	■	■	■	□	■
2.5	10	751NXF-2.5	■	■	■				761NXF-2.5	■	■	■			
3.0	10	751NXF-3.0	■	■	■				761NXF-3.0	■	■	■			

■ = disponible / verfügbar / available
□ = selon disponibilité du stock / jenach Lagerverfügbarkeit / depending on stock availability

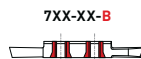

7XX-XX-B
Sur demande pour serrage type B, voir page 1.03
Wahlweise mit B-Spannsystem, siehe Seite 1.03
On request for B clamping system, see page 1.03

Tronçonnage
Abstechen
Parting off

Coupe déportée
Versetztes Schneiden
Cut off line

761L / 751R

Cut L

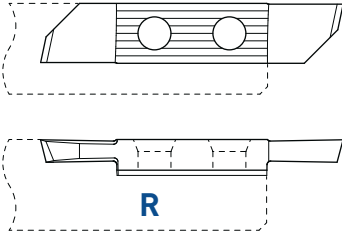

Cut R

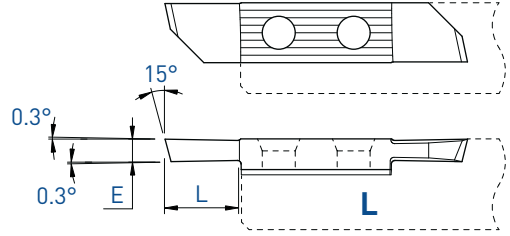

R (L)

Coupe à gauche déportée
 Versetztes Linksschneiden
 Left cut off line

L (R)

Coupe à droite déportée
 Versetztes Rechtsschneiden
 Right cut off line

E	L	Art. N°	TiAlN	TiN	N (µk20)	HTA	HTiN	HN (µk10)	Art. N°	TiAlN	TiAlX	TiN	N (µk20)	HTA	HTiN	HN (µk10)
1.0	5	761L-1.0	■	■	■	■	□	■	751R-1.0	■	■	■	■	■	□	■
1.5	7.5	761L-1.5	■	■	■	■	□	■	751R-1.5	■	■	■	■	■	□	■
1.8	7.5	761L-1.8	■	■	■				751R-1.8	■	■	■	■	■	□	■
2.0	10	761L-2.0	■	■	■	■	□	■	751R-2.0	■	■	■	■	■	■	■
2.2	10	761L-2.2	■	■	■				751R-2.2	■	■	■	■			
2.5	10	761L-2.5	■	■	■	■	□	■	751R-2.5	■	■	■	■	■	■	■
3.0	10	761L-3.0	■	■	■				751R-3.0	■	■	■	■	■	□	■

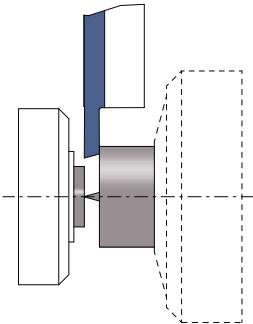

Tronçonnage
Abstechen
Parting off

Coupe déportée
Versetztes Schneiden
Cut off line

761LS / 751RS

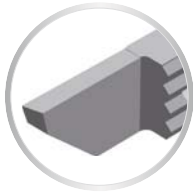
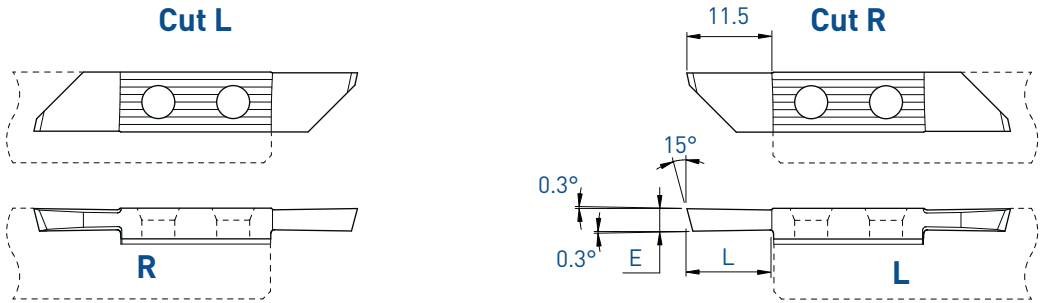

R (L)	L (R)
Coupe à gauche déportée Versetztes Linksschneiden Left cut off line	Coupe à droite déportée Versetztes Rechtsschneiden Right cut off line

E	L	Art. N°	TiAlN	TiN	N (µk20)	HTA	HTiN	HN (µk10)	Art. N°	TiAlN	TiAlX	TiN	N (µk20)	HTA	HTiN	HN (µk10)
1.0	5.5	761LS-1.0	■	■	■	■	□	■	751RS-1.0	■	■	■	■	■	□	■
1.5	8	761LS-1.5	■	■	■	■	□	■	751RS-1.5	■	■	■	■	■	□	■
2.0	11.5	761LS-2.0	■	■	■				751RS-2.0	■	■	■	■	■	■	■
2.2	11.5	761LS-2.2	■	■	■				751RS-2.2	■	■	■	■	■	□	■
2.5	11.5	761LS-2.5	■	■	■				751RS-2.5	■	■	■	■	■	□	■
3.0	11.5	761LS-3.0	■	■	■				751RS-3.0	■	■	■	■	■	□	■

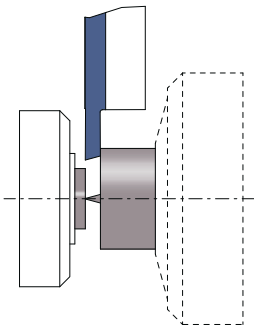

■ = disponible / verfügbar / available
□ = selon disponibilité du stock / jenach Lagerverfügbarkeit / depending on stock availability

TOP-LINE

Tronçonnage
Abstechen
Parting off

Coupe déportée
Versetztes Schneiden
Cut off line

761L-R05 / 751R-R05

Cut L

Cut R

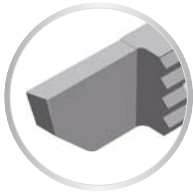
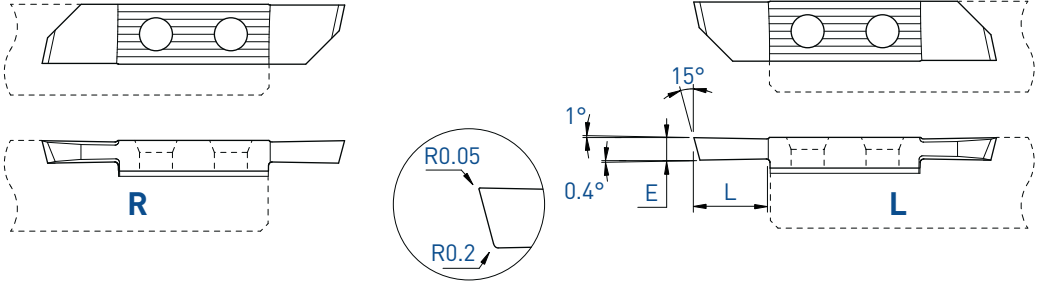

R (L)

Coupe à gauche déportée
Versetztes Linksschneiden
Left cut off line

L (R)

Coupe à droite déportée
Versetztes Rechtsschneiden
Right cut off line

E	L	Art. N°	TiAlN	TiN	N (µk20)	HTA	HTiN	HN (µk10)	Art. N°	TiAlN	TiAlX	TiN	N (µk20)	HTA	HTiN	HN (µk10)
1.5	7.5	761L-1.5-R05	■	■	■				751R-1.5-R05	■	■	■	■	■	□	■
2.0	10	761L-2.0-R05	■	■	■				751R-2.0-R05	■	■	■	■			

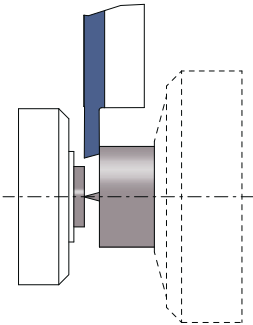

Tronçonnage
Abstechen
Parting off

Coupe déportée
Versetztes Schneiden
Cut off line

761LX4 / 751RX4

Cut L

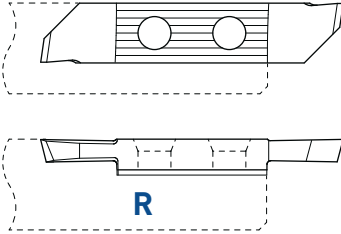

Cut R

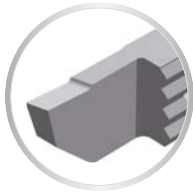
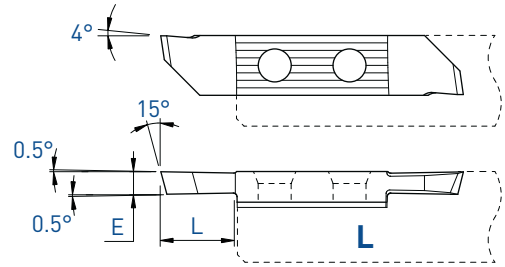

R (L)

Coupe à gauche déportée
Versetztes Linksschneiden
Left cut off line

L (R)

Coupe à droite déportée
Versetztes Rechtsschneiden
Right cut off line

E	L	Art. N°	TiAlN	TiN	N [µk20]	HTA	HTiN	HN [µk10]	Art. N°	TiAlN	TiN	N [µk20]	HTA	HTiN	HN [µk10]
1.5	7.5	-							751RX4-1.5	■	■	■	■	■	■
2.0	10	761LX4-2.0	■	■	■				751RX4-2.0	■	■	■	■	■	■
2.5	10	-							751RX4-2.5	■	■	■			

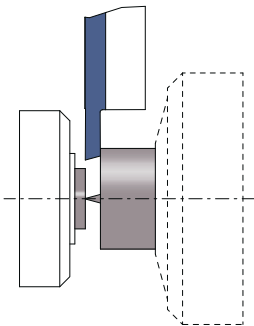

Tronçonnage
Abstechen
Parting off

Coupe déportée
Versetztes Schneiden
Cut off line

761LXF / 751RXF

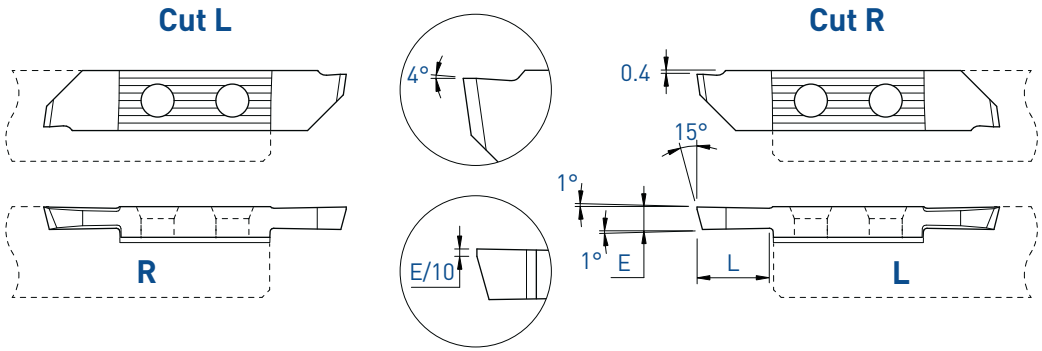

R (L)	L (R)
Coupe à gauche déportée Versetztes Linksschneiden Left cut off line	Coupe à droite déportée Versetztes Rechtsschneiden Right cut off line

E	L	Art. N°	TiAlN	TiN	N (µk20)	HTA	HTiN	HN (µk10)	Art. N°	TiAlN	TiN	N (µk20)	HTA	HTiN	HN (µk10)
1.5	7.5	-							751RXF-1.5	■	■	■	■	□	■
2.0	10	761LXF-2.0	■	■	■				751RXF-2.0	■	■	■	■	■	■
2.5	10	761LXF-2.5	■	■	■				751RXF-2.5	■	■	■	■	□	■
3.0	10	761LXF-3.0	■	■	■				751RXF-3.0	■	■	■	■	□	■

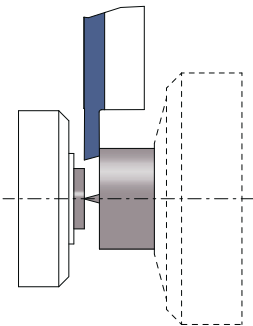

Tronçonnage
Abstechen
Parting off

Coupe déportée
Versetztes Schneiden
Cut off line

761LX12 / 751RX12

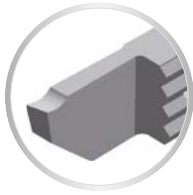
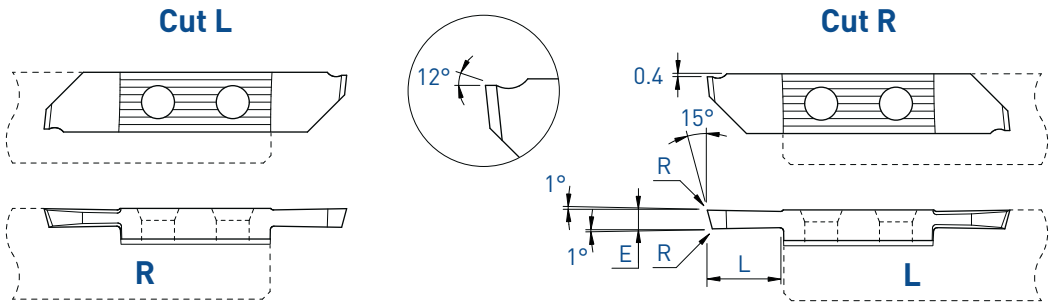

			R (L) Coupe à gauche déportée Versetztes Linksschneiden Left cut off line					L (R) Coupe à droite déportée Versetztes Rechtsschneiden Right cut off line								
E	L	R	Art. N°	TiAlN	TiN	N [µk20]	HTA	HTiN	HN [µk10]	Art. N°	TiAlN	TiN	N [µk20]	HTA	HTiN	HN [µk10]
1.5	7.5	0.03	-							751RX12-1.5	■	■	■			
2.0	10	0.03	761LX12-2.0	■	■	■				751RX12-2.0	■	■	■	■	■	■

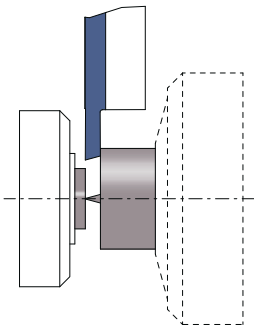

TOP-LINE

Tronçonnage
Abstechen
Parting off

Coupe déportée
Versetztes Schneiden
Cut off line

761LX25 / 751RX25

Cut L

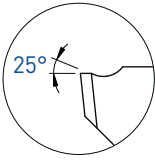
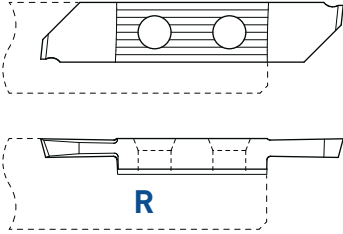

Cut R

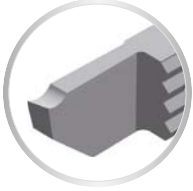
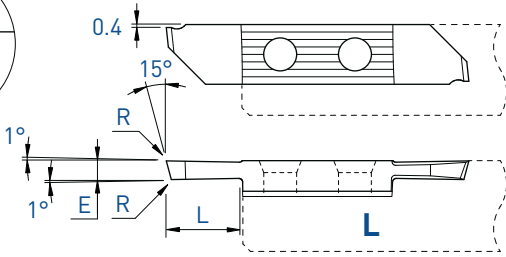

R (L)

Coupe à gauche déportée
Versetztes Linksschneiden
Left cut off line

L (R)

Coupe à droite déportée
Versetztes Rechtsschneiden
Right cut off line

E	L	R	Art. N°	TiAIN	TiN	N (µk20)	Art. N°	TiAIN	TiN	N (µk20)
2.0	10	0.03	761LX25-2.0	■	■	■	751RX25-2.0	■	■	■

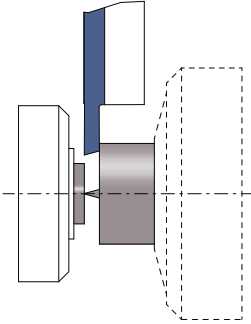

Tronçonnage
Abstechen
Parting off

Coupe déportée
Versetztes Schneiden
Cut off line

751RU

Cut R

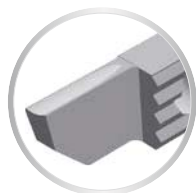
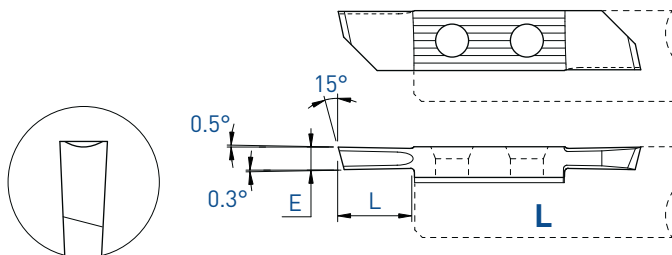

L (R)
Coupe à droite déportée
Versetztes Rechtsschneiden
Right cut off line

E	L	Art. N°	TiAIN	TiN	N (µk20)
1.5	7.5	751RU-1.5	■	■	■
2.0	10	751RU-2.0	■	■	■

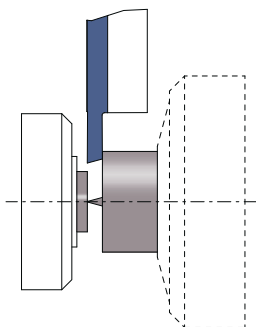

Tronçonnage

Abstechen

Parting off

Coupe déportée

Versetztes Schneiden

Cut off line

751RZU

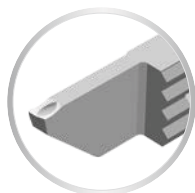
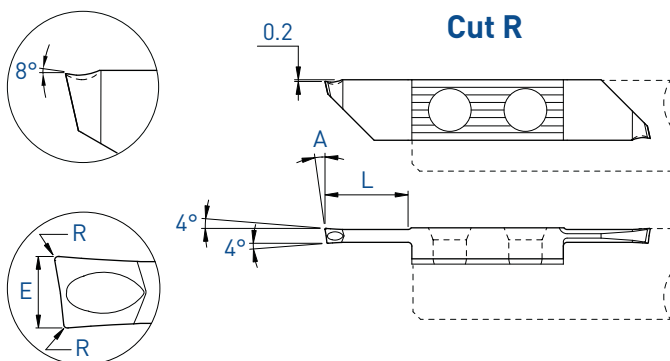

R (L)

Coupe à gauche déportée
Versetztes Linksschneiden
Left cut off line

E	A	L	R	Art. N°	TiAlN	TiN	N (µm20)
2.0	8°	11.0	0.10	751RZU8-2.0-8°-R10	■		

Tronçonnage
Abstechen
Parting off

Coupe déportée
Versetztes Schneiden
Cut off line

761NXF / 751NXF

Cut L

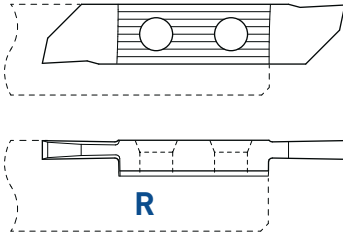

Cut R

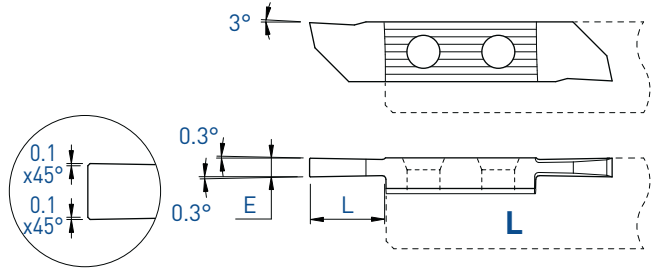

R (L)

Coupe à gauche déportée
Versetztes Linksschneiden
Left cut off line

L (R)

Coupe à droite déportée
Versetztes Rechtsschneiden
Right cut off line

E	L	Art. N°	TiAlN	TiN	N (µk20)	HTA	HTiN	HN (µk10)	Art. N°	TiAlN	TiN	N (µk20)	HTA	HTiN	HN (µk10)
2.0	10	761NXF-2.0	■	■	■	■	□	■	751NXF-2.0	■	■	■	■	□	■
2.5	10	761NXF-2.5	■	■	■				751NXF-2.5	■	■	■			
3.0	10	761NXF-3.0	■	■	■				751NXF-3.0	■	■	■			

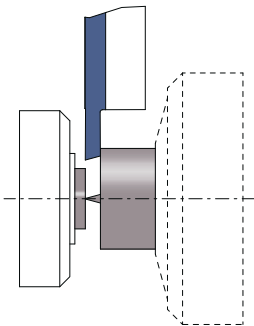

Tronçonnage
Abstechen
Parting off

Coupe déportée
Versetztes Schneiden
Cut off line

761LD / 751RD

Cut L

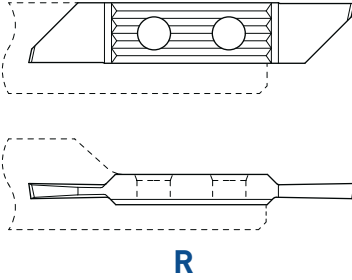

Cut R

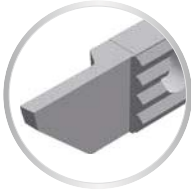
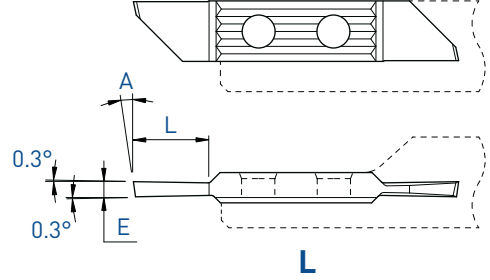

R (L)

Coupe à gauche déportée
 Versetztes Linksschneiden
 Left cut off line

L (R)

Coupe à droite déportée
 Versetztes Rechtsschneiden
 Right cut off line

E	A	L	Art. N°	TiAlN	TiN	N (µk20)	HTA	HTiN	HN (µk10)	Art. N°	TiAlN	TiN	N (µk20)	HTA	HTiN	HN (µk10)
1.0	8°	5	761LD-1.0-8°	■	■	■	■	□	■	751RD-1.0-8°	■	■	■	■	□	■
1.0	15°	5	761LD-1.0-15°	■	■	■	■	□	■	751RD-1.0-15°	■	■	■	■	□	■
1.2	8°	5	761LD-1.2-8°	■	■	■				751RD-1.2-8°	■	■	■	■	□	■
1.5	8°	8	761LD-1.5-8°	■	■	■				751RD-1.5-8°	■	■	■	■	■	■
1.5	15°	8	761LD-1.5-15°	■	■	■				751RD-1.5-15°	■	■	■	■	□	■
1.6	8°	8	761LD-1.6-8°	■	■	■				751RD-1.6-8°	■	■	■			
1.8	8°	10	761LD-1.8-8°	■	■	■				751RD-1.8-8°	■	■	■	■	□	■
2.0	8°	10	761LD-2.0-8°	■	■	■				751RD-2.0-8°	■	■	■	■	□	■
2.0	15°	10	761LD-2.0-15°	■	■	■	■	□	■	751RD-2.0-15°	■	■	■	■	□	■
2.5	8°	10	-							751RD-2.5-8°	■	■	■	■	□	■

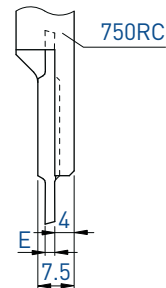
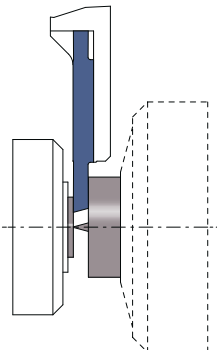

Tronçonnage
Abstechen
Parting off

Coupe déportée
Versetztes Schneiden
Cut off line

751RAS

Cut R

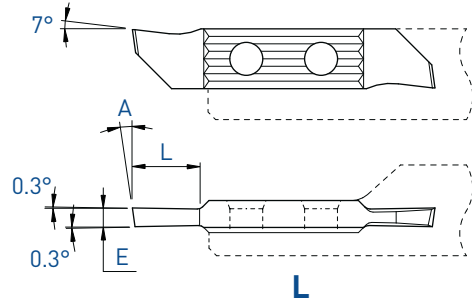

L (R)

Coupe à droite déportée
Versetztes Rechtsschneiden
Right cut off line

E	A	L	Art. N°	TiAlN	TiN	N (µk20)	HTA	HTiN	HN (µk10)
1.6	8°	7.5	751RAS-1.6-8°	■	■	■			
1.6	15°	7.5	751RAS-1.6-15°	■	■	■	■	□	■
2.0	8°	9	751RAS-2.0-8°	■	■	■	■	□	■
2.0	15°	9	751RAS-2.0-15°	■	■	■			
2.5	8°	9	751RAS-2.5-8°	■	■	■			
2.5	15°	9	751RAS-2.5-15°	■	■	■			

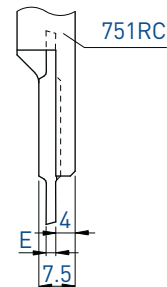
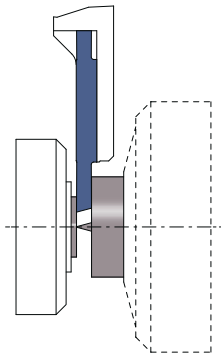

TOP-LINE

Tournage avant
Vorwärts drehen
Front turning

752 / 762

L

R

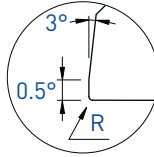
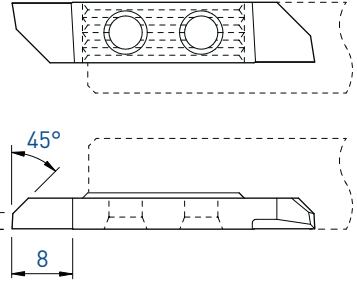
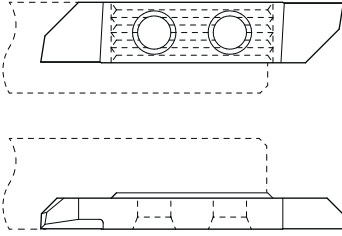

L

R

A	R	Art. N°	TiAlN	TiN	N (µk20)	HTA	HTiN	HN (µk10)	Art. N°	TiAlN	TiN	N (µk20)	HTA	HTiN	HN (µk10)
0°	0	752	■	■	■	■	□	■	762	■	■	■	■	□	■
0°	0.20	-							762-R20	■	■	■	■	□	■
3°	0	752-3°	■	■	■	■	□	■	762-3°	■	■	■	■	□	■

7XX-XX-B



Sur demande pour serrage type B, voir page 1.03
Wahlweise mit B-Spannsystem, siehe Seite 1.03
On request for B clamping system, see page 1.03

Tournage avant
Vorwärts drehen
Front turning

752PX / 762PX

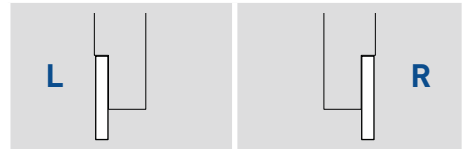
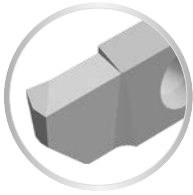
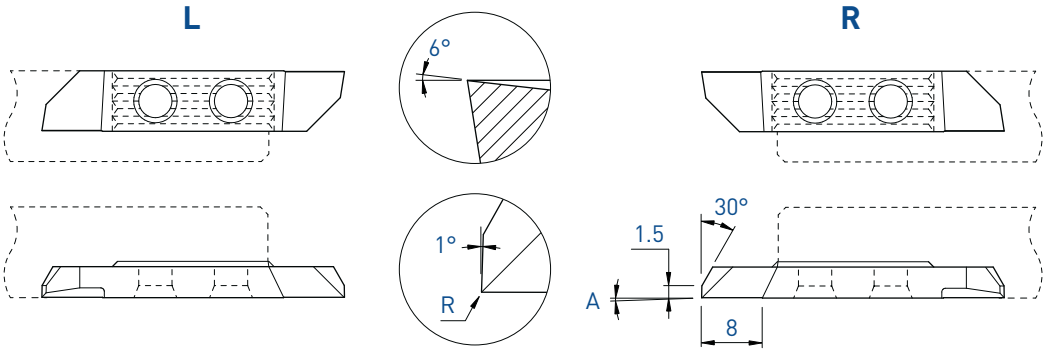

A	R	Art. N°	TiAlN	TiN	N (µk20)	Art. N°	TiAlN	TiN	N (µk20)
0°	0	752PX	■	■	■	762PX	■	■	■

7XX-XX-B



Sur demande pour serrage type B, voir page 1.03
Wahlweise mit B-Spannsystem, siehe Seite 1.03
On request for B clamping system, see page 1.03

■ = disponible / verfügbar / available
□ = selon disponibilité du stock / jenach Lagerverfügbarkeit / depending on stock availability

TOP-LINE

Tournage avant
Vorwärts drehen
Front turning

752X / 762X

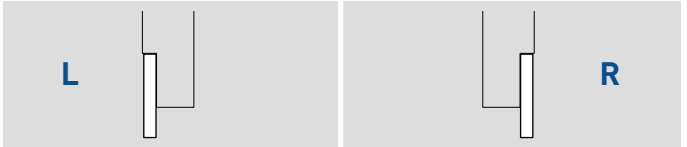
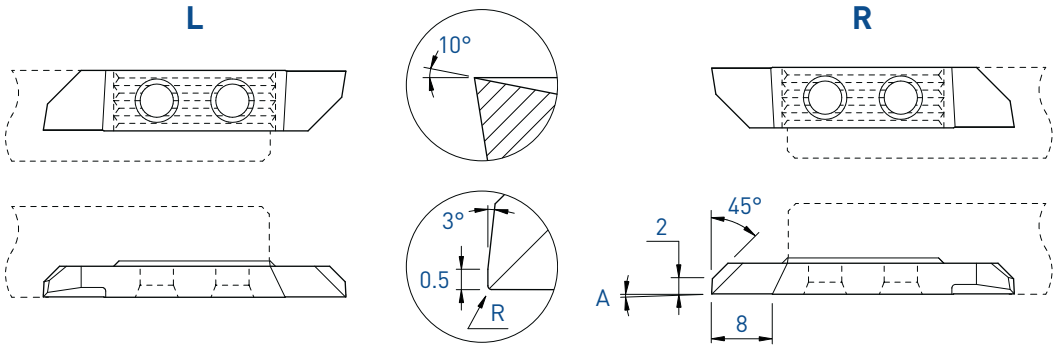

A	R	Art. N°	TiAlN	TiN	N (µk20)	HTA	HTiN	HN (µk10)	Art. N°	TiAlN	TiN	N (µk20)	HTA	HTiN	HN (µk10)
0°	0	752X	■	■	■	■	■	■	762X	■	■	■	■	■	■
0°	0.20	752X-R20	■	■	■				762X-R20	■	■	■	■	■	■

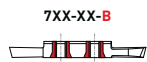

7XX-XX-B
Sur demande pour serrage type B, voir page 1.03
Wahlweise mit B-Spannsystem, siehe Seite 1.03
On request for B clamping system, see page 1.03

Tournage avant
 Vorwärts drehen
 Front turning

762VX-800

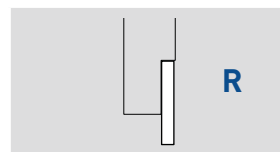
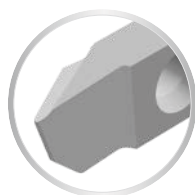
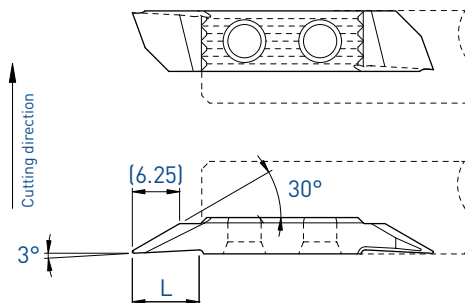
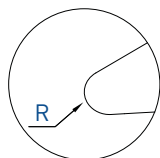
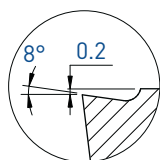

L	R	Art. N°	HTA	HTiN	HN [µk10]
9	0.15	762VX-800-R15	■	■	■

Tournage avant
Vorwärts drehen
Front turning

762VUX

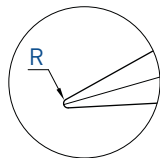
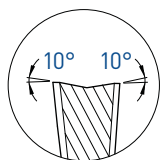

R

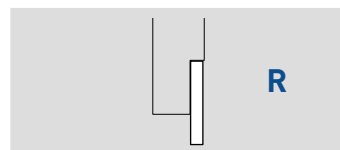
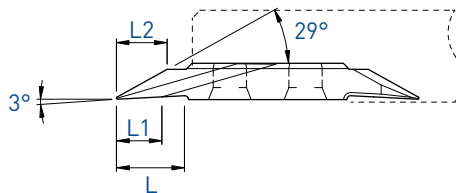
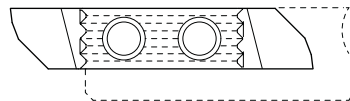

L	L1	L2	R	Art. N°	TiAlN N [µk20]	HTA	HN [µk10]
9	6	6.9	0.08	762VUX10-29°-R08	■	■	■
9	6	6.7	0.15	762VUX10-29°-R15	■	■	■
9	6	6.1	0.35	762VUX10-29°-R35	■	■	■
9	6	4.9	0.75	762VUX10-29°-R75	■	■	■

Tournage avant
Vorwärts drehen
Front turning

762ZX

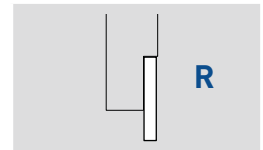
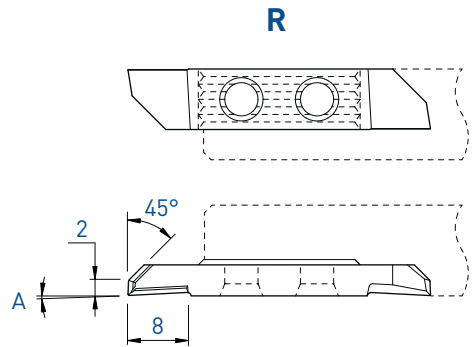
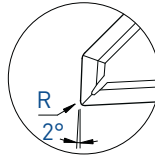
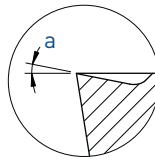

a	A	R	Art. N°	TiAIN	TiN	N (µk20)
10°	3°	0.08	762ZX10-R08	■	□	
	3°	0.20	762ZX10-R20	■	□	

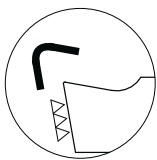

Arête de coupe honée
Gehonte Schneidkante
Honed edge

f min: 0.02 mm/U

7XX-XX-B

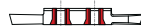

Sur demande pour serrage type B, voir page 1.03
Wahlweise mit B-Spannsystem, siehe Seite 1.03
On request for B clamping system, see page 1.03

TOP-LINE

Tournage multifonction
 Mehrzweck Drehen
 Multifunction turning

752S / 762S
 753S / 763S

L

R

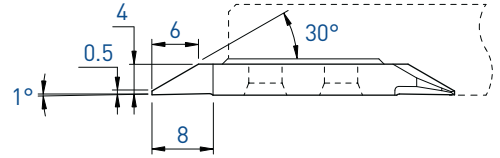
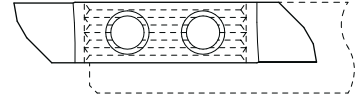
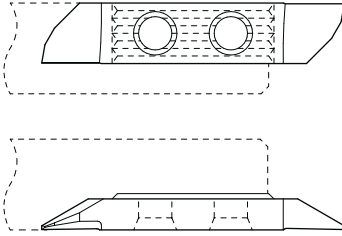

Tournage avant
 Vorwärts drehen
 Front turning

L						R								
Art. N°	TiAlN	TiN	N (µk20)	HTA	HTiN	HN (µk10)	Art. N°	TiAlN	TiAlX	TiN	N (µk20)	HTA	HTiN	HN (µk10)
752S05	■	■	■	■	□	■	762S05	■	■	■	■	■	■	■

L

R

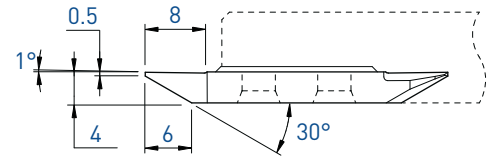
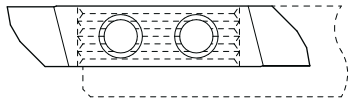
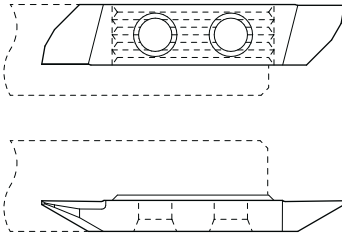

Tournage arrière
 Rückwärts drehen
 Back turning

L						R								
Art. N°	TiAlN	TiN	N (µk20)	HTA	HTiN	HN (µk10)	Art. N°	TiAlN	TiAlX	TiN	N (µk20)	HTA	HTiN	HN (µk10)
753S05	■	■	■	■	■	■	763S05	■	■	■	■	■	■	■

Tournage arrière
Rückwärts drehen
Back turning

753 / 763

L

R

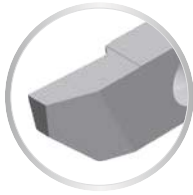
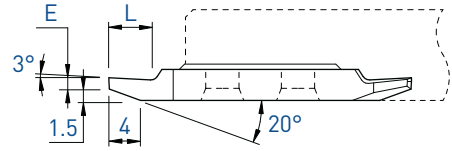
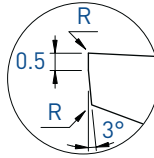
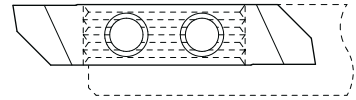
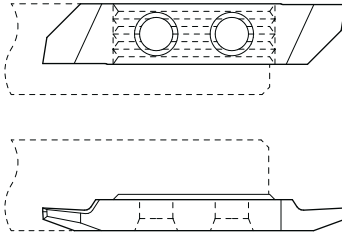

L

R

E	L	R	Art. N°	TiAlN	TiN	N (µk20)	HTA	HTiN	HN (µk10)	Art. N°	TiAlN	TiN	N (µk20)	HTA	HTiN	HN (µk10)
1.0	5	0	753-1.0	■	■	■	■	□	■	763-1.0	■	■	■	■	■	■
1.0	5	0.08	753-1.0-R08	■	■	■				763-1.0-R08	■	■	■	■	□	■
1.5	6	0	753-1.5	■	■	■				763-1.5	■	■	■	■	□	■
2.0	7.5	0	753-2.0	■	■	■				763-2.0	■	■	■	■	□	■
2.5	9	0	753-2.5	■	■	■				763-2.5	■	■	■	■	□	■

7XX-XX-B



Sur demande pour serrage type B, voir page 1.03
Wahlweise mit B-Spannsystem, siehe Seite 1.03
On request for B clamping system, see page 1.03

■ = disponible / verfügbar / available
□ = selon disponibilité du stock / jenach Lagerverfügbarkeit / depending on stock availability

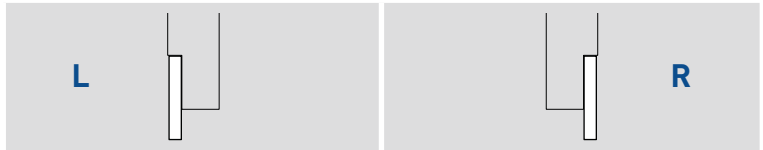
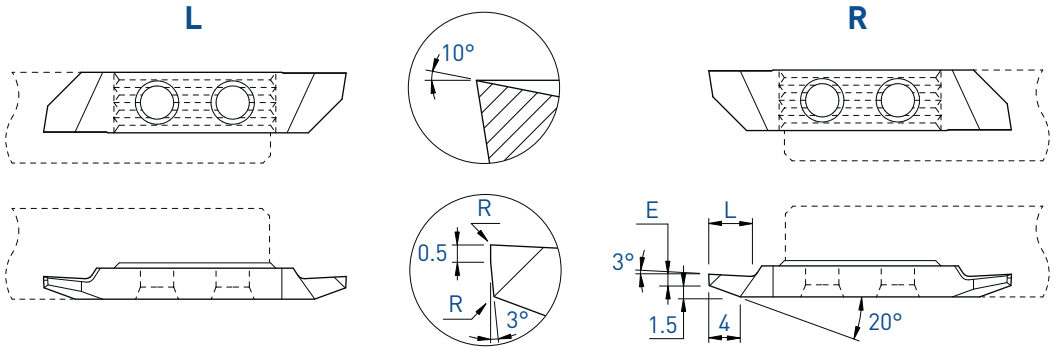

E	L	R	L				R								
			Art. N°	TiAlN	TiN	N (µk20)	HTA	HTiN	HN (µk10)	Art. N°	TiAlN	TiN	N (µk20)	HTA	HTiN
1.0	5	0	753X-1.0	■	■	■			763X-1.0	■	■	■	■	□	■
1.0	5	0.08	753X-1.0-R08	■	■	■	■	□	763X-1.0-R08	■	■	■	■	□	■
1.0	5	0.20	753X-1.0-R20	■	■	■			763X-1.0-R20	■	■	■			
1.5	6	0	753X-1.5	■	■	■			763X-1.5	■	■	■	■	□	■
1.5	6	0.20	753X-1.5-R20	■	■	■			763X-1.5-R20	■	■	■			
2.0	7.5	0	753X-2.0	■	■	■			763X-2.0	■	■	■			
2.0	7.5	0.20	753X-2.0-R20	■	■	■			763X-2.0-R20	■	■	■			
2.5	9	0	753X-2.5	■	■	■			763X-2.5	■	■	■			
2.5	9	0.20	753X-2.5-R20	■	■	■			763X-2.5-R20	■	■	■			

7XX-XX-B



Sur demande pour serrage type B, voir page 1.03
Wahlweise mit B-Spannsystem, siehe Seite 1.03
On request for B clamping system, see page 1.03

Tournage arrière
Rückwärts drehen
Back turning

753XS / 763XS

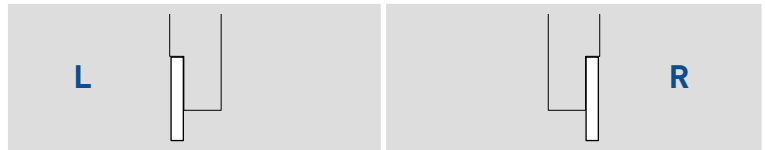
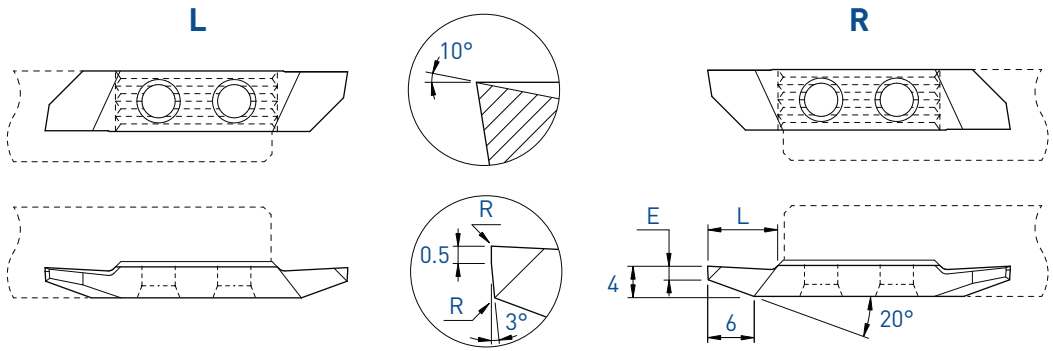

E	L	R	Art. N°	TiAlN	TiN	N (µk20)	HTA	HTiN	HN (µk10)	Art. N°	TiAlN	TiN	N (µk20)	HTA	HTiN	HN (µk10)
1.8	9	0	753XS-1.8	■	■	■				763XS-1.8	■	■	■	■	□	■
1.8	9	0.20	753XS-1.8-R20	■	■	■				763XS-1.8-R20	■	■	■			

7XX-XX-B



Sur demande pour serrage type B, voir page 1.03
Wahlweise mit B-Spannsystem, siehe Seite 1.03
On request for B clamping system, see page 1.03

■ = disponible / verfügbar / available
□ = selon disponibilité du stock / jenach Lagerverfügbarkeit / depending on stock availability

TOP-LINE

Tournage arrière
Rückwärts drehen
Back turning

753VX-8° / 763VX-8°

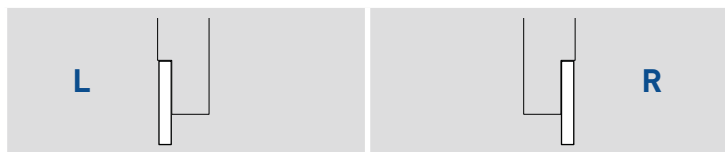
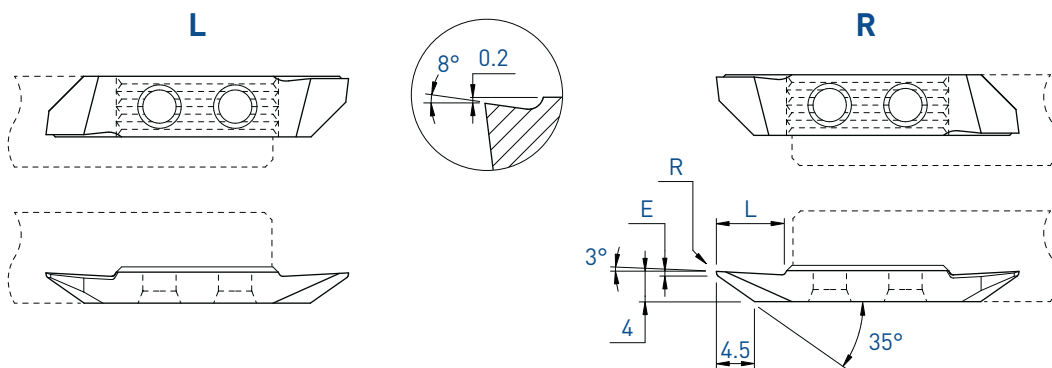

E	L	R	Art. N°	L			R								
				TiAlN	TiN	N (µk20)	HTA	HTiN	HN (µk10)	Art. N°	TiAlN	TiN	N (µk20)	HTA	HTiN
~ 1.0	9	0	753VX-8°	■	■	■			763VX-8°	■	■	■	■	■	■
~ 1.0	9	0.08	753VX-8°-R08	■	■	■			763VX-8°-R08	■	■	■	■	□	■
~ 1.0	9	0.20	-						763VX-8°-R20	■	■	■			

7XX-XX-B



Sur demande pour serrage type B, voir page 1.03
Wahlweise mit B-Spannsystem, siehe Seite 1.03
On request for B clamping system, see page 1.03

Tournage arrière
 Rückwärts drehen
 Back turning

753VX-805 / 763VX-805

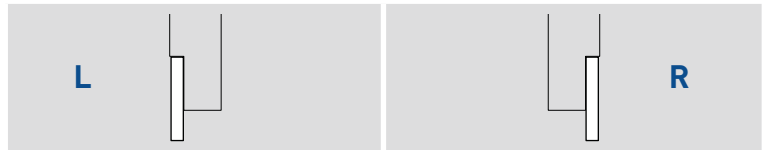
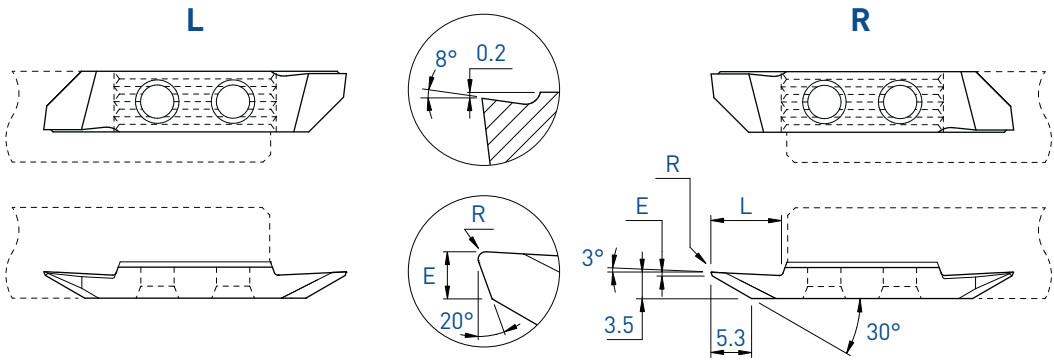

E	L	R	Art. N°	TiAlN	TiN	N (µk20)	HTA	HTiN	HN (µk10)	Art. N°	TiAlN	TiN	N (µk20)	HTA	HTiN	HN (µk10)
0.5	9	0.08	753VX-805-R08	■	■	■	■	□	■	763VX-805-R08	■	■	■	■	□	■

7XX-XX-B



Sur demande pour serrage type B, voir page 1.03
 Wahlweise mit B-Spannsystem, siehe Seite 1.03
 On request for B clamping system, see page 1.03

■ = disponible / verfügbar / available
 □ = selon disponibilité du stock / jenach Lagerverfügbarkeit / depending on stock availability

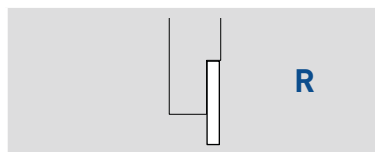
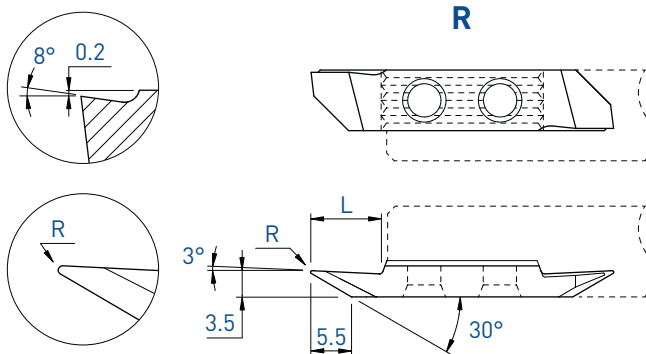

L	R	Art. N°	TiAlN	TiN	N (µk20)	HTA	HTiN	HN (µk10)
9	0.08	763VX-800-R08	■	■	■	■	□	■
9	0.20	763VX-800-R20	■	■	■	■	□	■

7XX-XX-B



Sur demande pour serrage type B, voir page 1.03
Wahlweise mit B-Spannsystem, siehe Seite 1.03
On request for B clamping system, see page 1.03

Tournage arrière
Rückwärts drehen
Back turning

753VX-15° / 763VX-15°

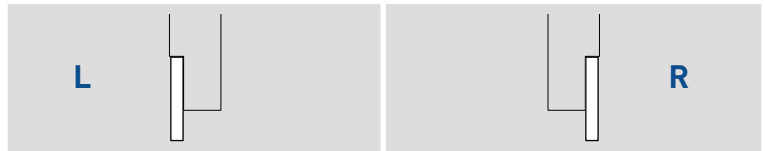
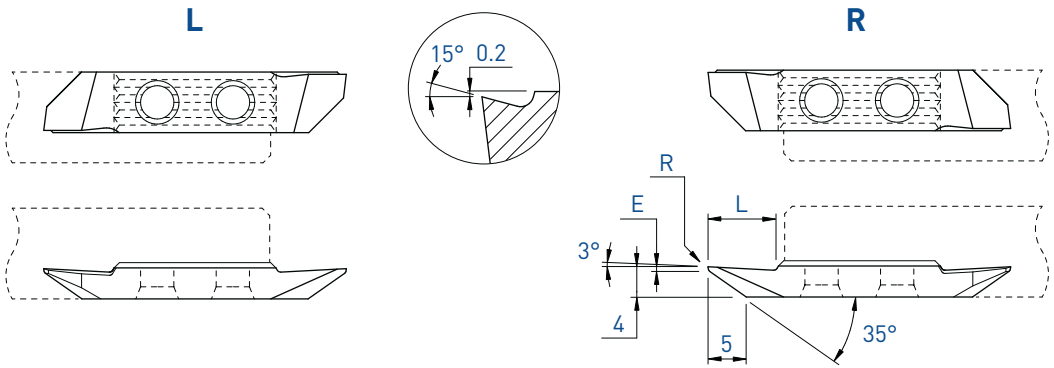

E	L	R	L				R									
			Art. N°	TiAlN	TiN	N (µk20)	HTA	HTiN	HN (µk10)	Art. N°	TiAlN	TiN	N (µk20)	HTA	HTiN	HN (µk10)
0.6	9	0	753VX-15°	■	■	■				763VX-15°	■	■	■	■	□	■
0.6	9	0.08	753VX-15°-R08	■	■	■				763VX-15°-R08	■	■	■	■	□	■

7XX-XX-B



Sur demande pour serrage type B, voir page 1.03
Wahlweise mit B-Spannsystem, siehe Seite 1.03
On request for B clamping system, see page 1.03

■ = disponible / verfügbar / available
□ = selon disponibilité du stock / jenach Lagerverfügbarkeit / depending on stock availability

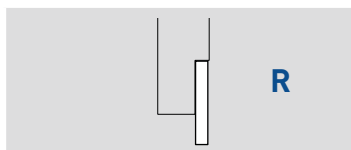
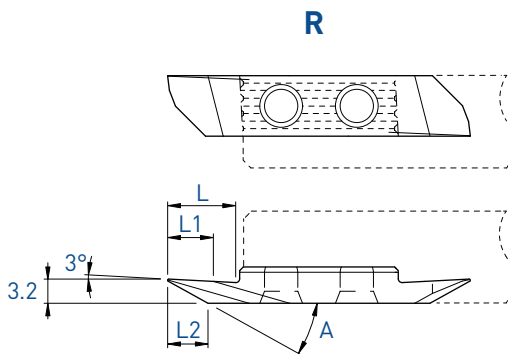
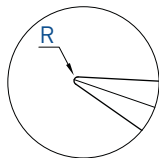
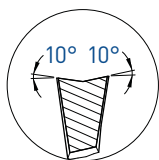

L	L1	L2	A	R	Art. N°	TiAlN N [µk20]	HTA	HN [µk10]
9	6	5.5	29	0.08	763VUX10-29°-R08	■	■	■
9	6	5.3	29	0.15	763VUX10-29°-R15	■	■	■
9	6	4.7	29	0.35	763VUX10-29°-R35	■	■	■
9	6	3.6	29	0.75	763VUX10-29°-R75	■	■	■
9	6	4.2	35	0.15	763VUX10-35°-R15	■	■	■
9	6	3.8	35	0.35	763VUX10-35°-R35	■	■	■

7XX-XX-B



Sur demande pour serrage type B, voir page 1.03
Wahlweise mit B-Spannsystem, siehe Seite 1.03
On request for B clamping system, see page 1.03

Tournage arrière
Rückwärts drehen
Back turning

753ZX / 763ZX

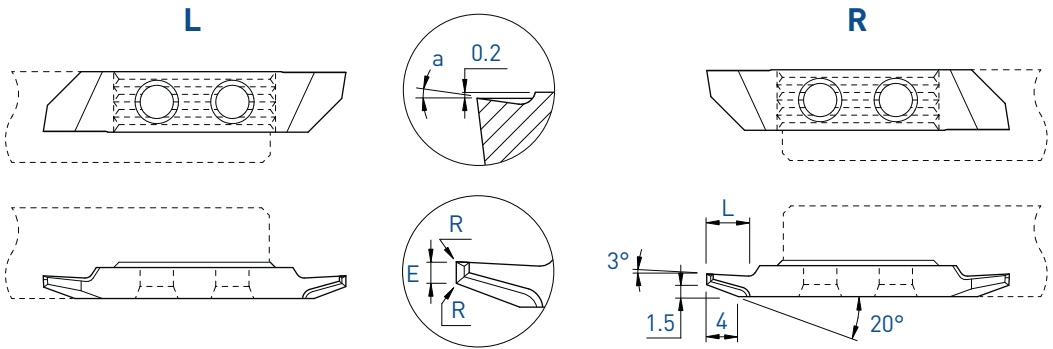

Pour un meilleur contrôle des copeaux
Für eine bessere Spankontrolle
For a better chip-control

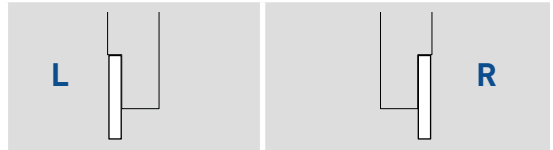

a	E	L	R	Art. N°	TiAlN	TiN	N (µm20)	Art. N°	TiAlN	TiN	N (µm20)
10°	1.0	5	0.01	753ZX10-1.0	■	□		763ZX10-1.0	■	■	
	1.0	5	0.08	-				763ZX10-1.0-R08	■	■	
	1.0	5	0.20	-				763ZX10-1.0-R20	■	■	



Arête de coupe honée
Gehonte Schneidkante
Honed edge

f min: 0.02 mm/U



Sur demande pour serrage type B, voir page 1.03
Wahlweise mit B-Spannsystem, siehe Seite 1.03
On request for B clamping system, see page 1.03

TOP-LINE

Tournage arrière / pré-coupe
 Rückwärts drehen / vorstechen
 Back turning / pre-parting off

753P / 763P

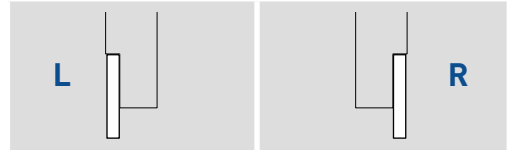
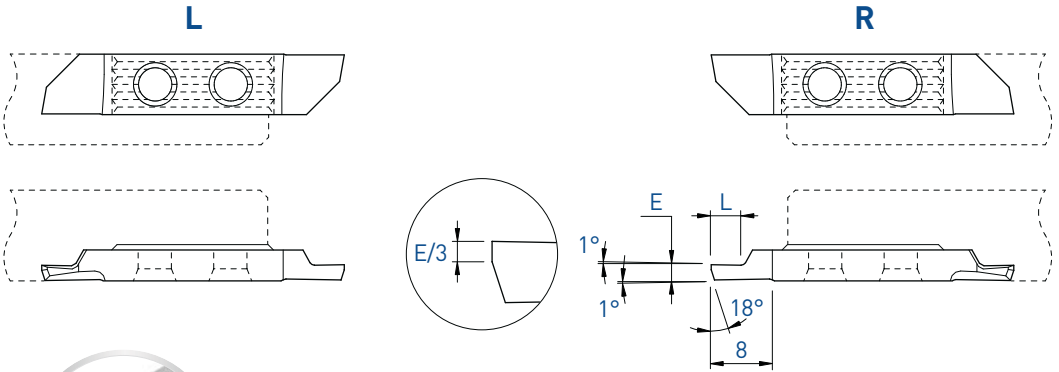

E	L	Art. N°	TiAlN	TiN	N (µk20)	Art. N°	TiAlN	TiN	N (µk20)
1.5	3	753P-1.5	■	■	■	763P-1.5	■	■	■
1.8	3.5	753P-1.8	■	■	■	763P-1.8	■	■	■
2.0	4	753P-2.0	■	■	■	763P-2.0	■	■	■
2.2	4.5	753P-2.2	■	■	■	763P-2.2	■	■	■
2.5	5	753P-2.5	■	■	■	763P-2.5	■	■	■
3.0	6	753P-3.0	■	■	■	763P-3.0	■	■	■

7XX-XX-B



Sur demande pour serrage type B, voir page 1.03
 Wahlweise mit B-Spannsystem, siehe Seite 1.03
 On request for B clamping system, see page 1.03

Fonçage-tournage

Einstecken und drehen

Grooving and turning

754 / 764

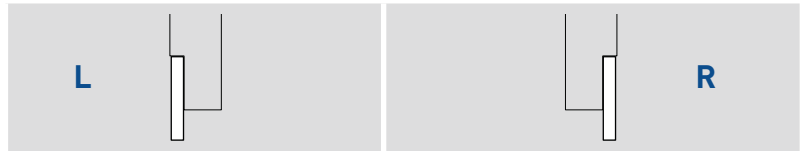
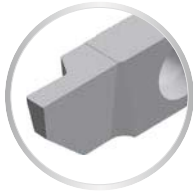
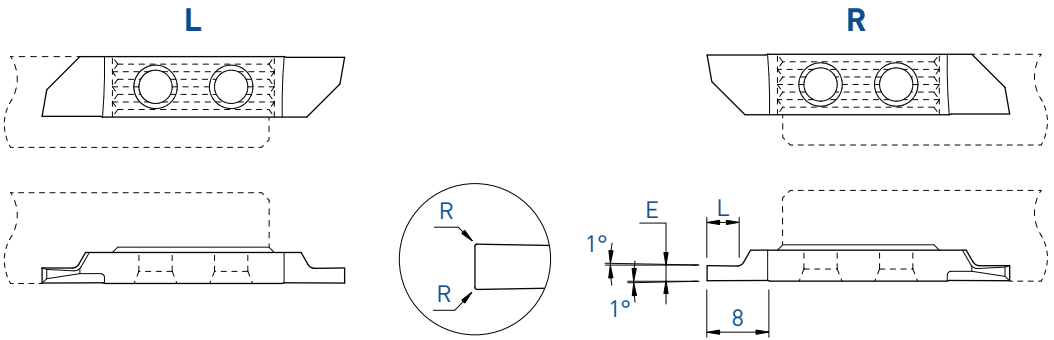

E	L	R	Art. N°	TiAlN	TiN	N (µk20)	HTA	HTiN	HN (µk10)	Art. N°	TiAlN	TiAlX	TiN	N (µk20)	HTA	HTiN	HN (µk10)
0.5	1.5	0	754-0.5	■	■	■				764-0.5	■	■	■	■	■	■	■
0.75	2	0	754-0.75	■	■	■				764-0.75	■	■	■	■	■	■	■
0.8	2	0	-							764-0.8	■	■	■	■	■	□	■
0.95	3	0	754-0.95	■	■	■	■	□	■	764-0.95	■	■	■	■	■	■	■
1.0	2.5	0	754-1.0	■	■	■	■	□	■	764-1.0	■	■	■	■	■	■	■
1.0	2.5	0.08	754-1.0-R08	■	■	■	■	□	■	764-1.0-R08	■	■	■	■	■	□	■
1.2	3	0	754-1.2	■	■	■	■			764-1.2	■	■	■	■	■	□	■
1.5	3	0	754-1.5	■	■	■	■	□	■	764-1.5	■	■	■	■	■	■	■
1.5	3	0.08	754-1.5-R08	■	■	■	■	□	■	764-1.5-R08	■	■	■	■	■	□	■
1.5	3	0.15	-							764-1.5-R15	■	■	□	■	■	■	■
1.5	3	0.20	-							764-1.5-R20	■	■	■	■	■	□	■
1.8	4	0	754-1.8	■	■	■	■			764-1.8	■	■	■	■	■	■	■
2.0	4	0	754-2.0	■	■	■	■	□	■	764-2.0	■	■	■	■	■	■	■
2.0	4	0.08	754-2.0-R08	■	■	■	■	□	■	764-2.0-R08	■	■	■	■	■	□	■
2.0	4	0.15	-							764-2.0-R15	■	■	□	■	■	■	■
2.0	4	0.20	754-2.0-R20	■	■	■	■			764-2.0-R20	■	■	■	■	■	■	■
2.5	6	0	754-2.5	■	■	■	■			764-2.5	■	■	■	■	■	□	■
2.5	6	0.15	-							764-2.5-R15	■	■	□	■	■	■	■
2.5	6	0.20	-							764-2.5-R20	■	■	■	■	■	□	■
3.0	6	0	754-3.0	■	■	■	■	□	■	764-3.0	■	■	■	■	■	□	■
3.0	6	0.08	754-3.0-R08	■	■	■	■			764-3.0-R08	■	■	■	■	■	□	■
3.0	6	0.15	-							764-3.0-R15	■	■	□	■	■	■	■
3.0	6	0.20	754-3.0-R20	■	■	■	■	□	■	764-3.0-R20	■	■	■	■	■	■	■
4.0	8	0	754-4.0	■	■	■	■	■	■	764-4.0	■	■	■	■	■	□	■

7XX-XX-B



Sur demande pour serrage type B, voir page 1.03
Wahlweise mit B-Spannsystem, siehe Seite 1.03
On request for B clamping system, see page 1.03

■ = disponible / verfügbar / available
□ = selon disponibilité du stock / jenach Lagerverfügbarkeit / depending on stock availability

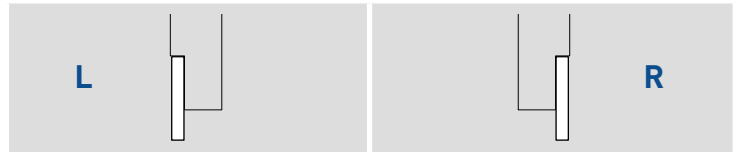
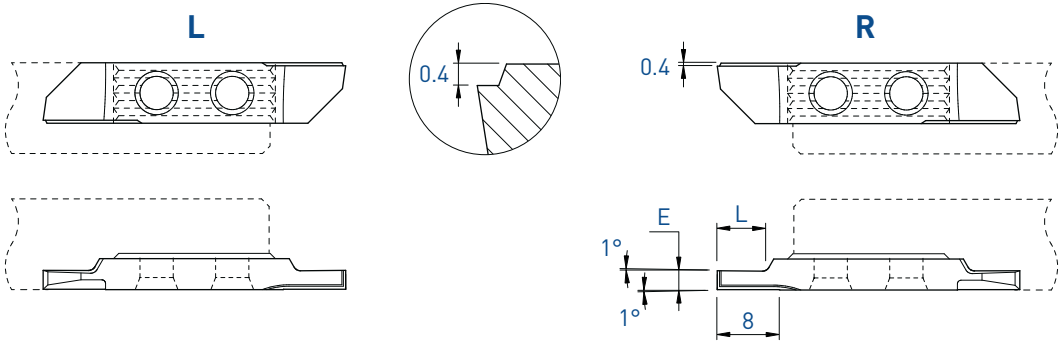

E	L	Art. N°	TiAlN			HTA	HTiN	HN (µk10)	Art. N°	TiAlN			HTA	HTiN	HN (µk10)
			TiN	N (µk20)						TiN	N (µk20)				
1.0	2	754VS-1.0	■	■	■				764VS-1.0	■	■	■			
1.2	2.5	754VS-1.2	■	■	■	■	□	■	764VS-1.2	■	■	■			
1.5	3	754VS-1.5	■	■	■				764VS-1.5	■	■	■			
2.0	4	754VS-2.0	■	■	■				764VS-2.0	■	■	■			
2.5	6	754VS-2.5	■	■	■				764VS-2.5	■	■	■	■	□	■
3.0	6	754VS-3.0	■	■	■				764VS-3.0	■	■	■			

7XX-XX-B



Sur demande pour serrage type B, voir page 1.03
Wahlweise mit B-Spannsystem, siehe Seite 1.03
On request for B clamping system, see page 1.03

Fonçage-tournage

Einstecken und drehen

Grooving and turning

754X / 764X

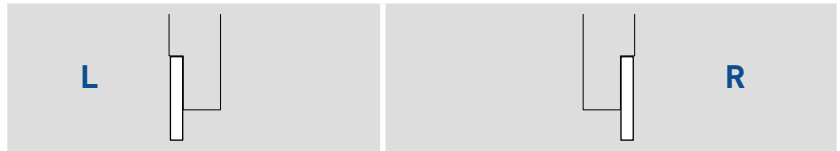
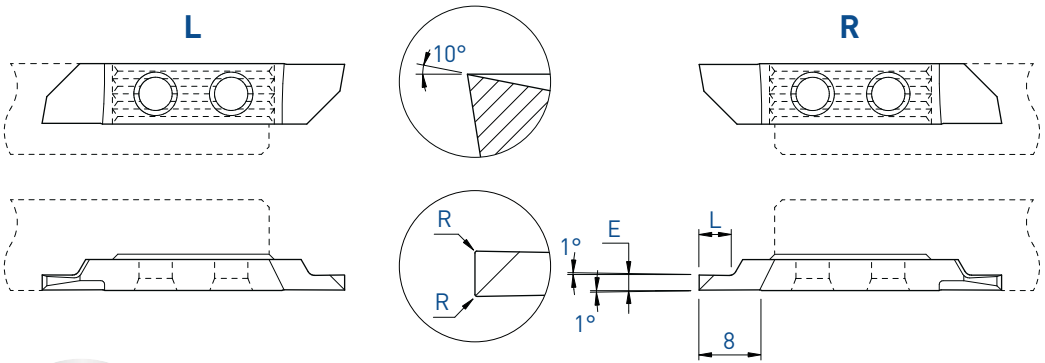

E	L	R	Art. N°	TiAlN	TiN	N (µk20)	HTA	HTiN	HN (µk10)	Art. N°	TiAlN	TiAlX	LoX	TiN	N (µk20)	HTA	HTiN	HN (µk10)
1.0	2.5	0	754X-1.0	■	■	■	■	■	■	764X-1.0	■	■	■	■	■	■	□	■
1.0	2.5	0.08	754X-1.0-R08	■	■	■	■	□	■	764X-1.0-R08	■	■	■	■	■	■	□	■
1.0	2.5	0.20	-							764X-1.0-R20	■	■	■	■	■			
1.2	3	0	754X-1.2	■	■	■				764X-1.2	■	■	■	■	■		□	■
1.2	3	0.08	-							764X-1.2-R08	■	■	■	■	■			
1.5	3	0	754X-1.5	■	■	■		□	■	764X-1.5	■	■	■	■	■		■	■
1.5	3	0.08	754X-1.5-R08	■	■	■		□	■	764X-1.5-R08	■	■	■	■	■		□	■
1.5	3	0.15	-							764X-1.5-R15	■	■	■	□	■		■	■
1.5	3	0.20	754X-1.5-R20	■	■	■				764X-1.5-R20	■	■	■	■	■		■	■
1.8	4	0	754X-1.8	■	■	■				764X-1.8	■	■	■	■	■		□	■
1.8	4	0.20	-							764X-1.8-R20	■	■	■	■	■			
2.0	4	0	754X-2.0	■	■	■		□	■	764X-2.0	■	■	■	■	■		■	■
2.0	4	0.08	754X-2.0-R08	■	■	■		□	■	764X-2.0-R08	■	■	■	■	■		□	■
2.0	4	0.15	-							764X-2.0-R15	■	■	■	□	■		■	■
2.0	4	0.20	754X-2.0-R20	■	■	■		□	■	764X-2.0-R20	■	■	■	■	■		□	■
2.0	4	0.35	-							764X-2.0-R35	■	■	■	□	■		■	■
2.5	6	0	754X-2.5	■	■	■		■	■	764X-2.5	■	■	■	■	■		■	■
2.5	6	0.15	-							764X-2.5-R15	■	■	■	□	■		■	■
2.5	6	0.20	754X-2.5-R20	■	■	■		□	■	764X-2.5-R20	■	■	■	■	■		□	■
2.5	6	0.35	-							764X-2.5-R35	■	■	■	□	■		■	■
3.0	6	0	754X-3.0	■	■	■				764X-3.0	■	■	■	■	■		□	■
3.0	6	0.08	754X-3.0-R08	■	■	■				764X-3.0-R08	■	■	■	■	■		□	■
3.0	6	0.15	-							764X-3.0-R15	■	■	■	□	■		■	■
3.0	6	0.20	754X-3.0-R20	■	■	■				764X-3.0-R20	■	■	■	■	■		□	■
3.0	6	0.35	-							764X-3.0-R35	■	■	■	□	■		■	■
4.0	8	0	754X-4.0	■	■	■				764X-4.0	■	■	■	■	■		□	■
4.0	8	0.20	754X-4.0-R20	■	■	■				764X-4.0-R20	■	■	■	■	■		□	■
4.0	8	0.35	-							764X-4.0-R35	■	■	■	□	■		■	■

■ = disponible / verfügbar / available
 □ = selon disponibilité du stock / jenach Lagerverfügbarkeit / depending on stock availability

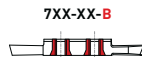

7XX-XX-B Sur demande pour serrage type B, voir page 1.03
 Wahlweise mit B-Spannsystem, siehe Seite 1.03
 On request for B clamping system, see page 1.03

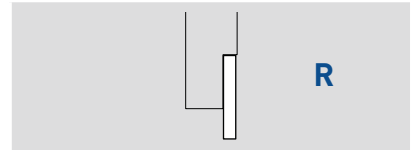
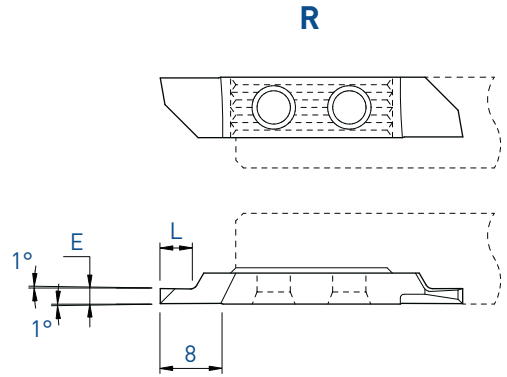
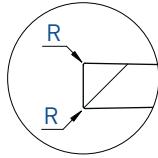
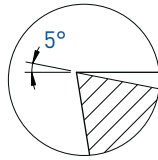

E	L	R	Art. N°	TiAIN	TiAlX	LOX	TiN	N (µm20)
1.5	3	0.08	764X5-1.5-R08-EP	■	■	■	■	■
2.0	4	0.08	764X5-2.0-R08-EP	■	■	■	■	■
2.5	6	0.08	764X5-2.5-R08-EP	■	■	■	■	■
2.5	6	0.15	764X5-2.5-R15-EP	■	■	■	■	■
3.0	6	0.08	764X5-3.0-R08-EP	■	■	■	■	■
3.0	6	0.15	764X5-3.0-R15-EP	■	■	■	■	■
4.0	8	0.15	764X5-4.0-R15-EP	■	■	■	■	■
4.0	8	0.35	764X5-4.0-R35-EP	■	■	■	■	■

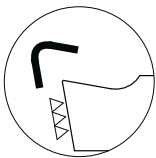

Arête de coupe honée
 Gehonte Schneidkante
 Honed edge



7XX-XX-B
 Sur demande pour serrage type B, voir page 1.03
 Wahlweise mit B-Spannsystem, siehe Seite 1.03
 On request for B clamping system, see page 1.03

Fonçage-tournage

Einstecken und drehen

Grooving and turning

764X10-EP

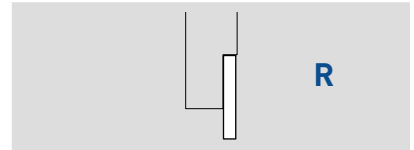
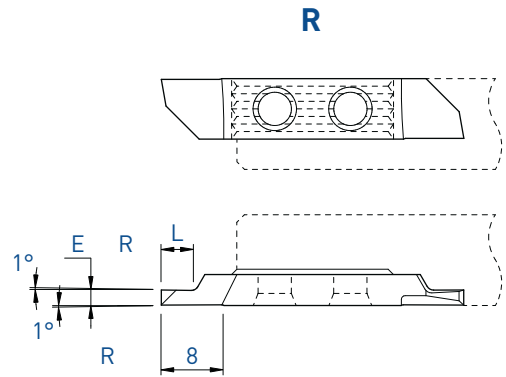
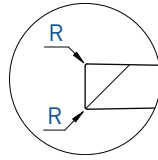
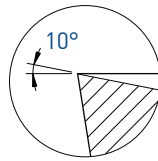

E	L	R	Art. N°	TiAIN	TiAlX	LOX	TiN	N (µm20)
1.5	3	0.08	764X10-1.5-R08-EP	■	■	■	■	■
2.0	4	0.08	764X10-2.0-R08-EP	■	■	■	■	■
2.5	6	0.08	764X10-2.5-R08-EP	■	■	■	■	■
2.5	6	0.15	764X10-2.5-R15-EP	■	■	■	■	■
3.0	6	0.08	764X10-3.0-R08-EP	■	■	■	■	■
3.0	6	0.15	764X10-3.0-R15-EP	■	■	■	■	■
4.0	8	0.15	764X10-4.0-R15-EP	■	■	■	■	■
4.0	8	0.35	764X10-4.0-R35-EP	■	■	■	■	■

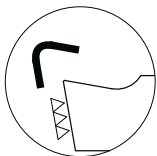

Arête de coupe honée
Gehonte Schneidkante
Honed edge



7XX-XX-B

Sur demande pour serrage type B, voir page 1.03
Wahlweise mit B-Spannsystem, siehe Seite 1.03
On request for B clamping system, see page 1.03

■ = disponible / verfügbar / available

□ = selon disponibilité du stock / jenach Lagerverfügbarkeit / depending on stock availability

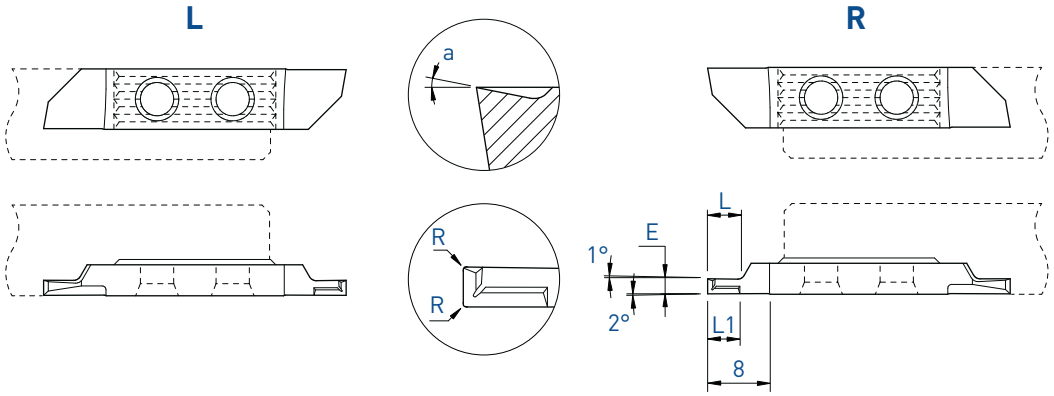

Pour un meilleur contrôle des copeaux
Für eine bessere Spankontrolle
For a better chip-control

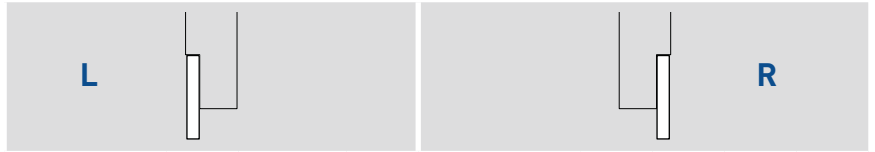

a	E	L	L1	R	Art. N°	L				R														
						TiAlN	TiN	N (µk20)	HTA	HAS	HTiN	HN (µk10)	TiAlN	TiAlX	TiN	N (µk20)	HTA	HAS	HTiN	HN (µk10)				
10°	1.5	4	4	0.03	754ZX10-1.5-R03	■	□						764ZX10-1.5-R03	■	■	■								
	1.5	4	4	0.08	754ZX10-1.5-R08	■	□						764ZX10-1.5-R08	■	■	■								
	2.0	4	4	0.08	754ZX10-2.0-R08	■	□						764ZX10-2.0-R08	■	■	■								
	2.0	4	4	0.20	-								764ZX10-2.0-R20	■	■	□								
	2.5	5	5	0.08	754ZX10-2.5-R08	■	■						764ZX10-2.5-R08	■	■	■								
	2.5	5	5	0.20	-								764ZX10-2.5-R20	■	■	■								
	3.0	6	6	0.08	754ZX10-3.0-R08	■	□						764ZX10-3.0-R08	■	■	■								
	3.0	6	6	0.20	-								764ZX10-3.0-R20	■	■	■								
25°	2.0	4	4	0.08	-								764ZX25-2.0-R08								■	■	□	
	2.0	4	4	0.20	-								764ZX25-2.0-R20								■	■	□	
	2.5	5	5	0.08	-								764ZX25-2.5-R08								■	■	□	
	2.5	5	5	0.20	-								764ZX25-2.5-R20								■	■	□	

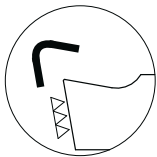

Arête de coupe honée
Gehonte Schneidkante
Honed edge

f min: 0.02 mm/U



7XX-XX-B

Sur demande pour serrage type B, voir page 1.03
Wahlweise mit B-Spannsystem, siehe Seite 1.03
On request for B clamping system, see page 1.03

Fonçage-tournage

Einstechen und drehen

Grooving and turning

764ZXB

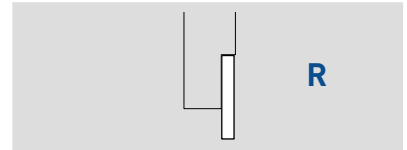
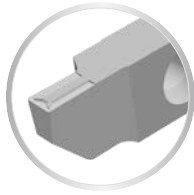
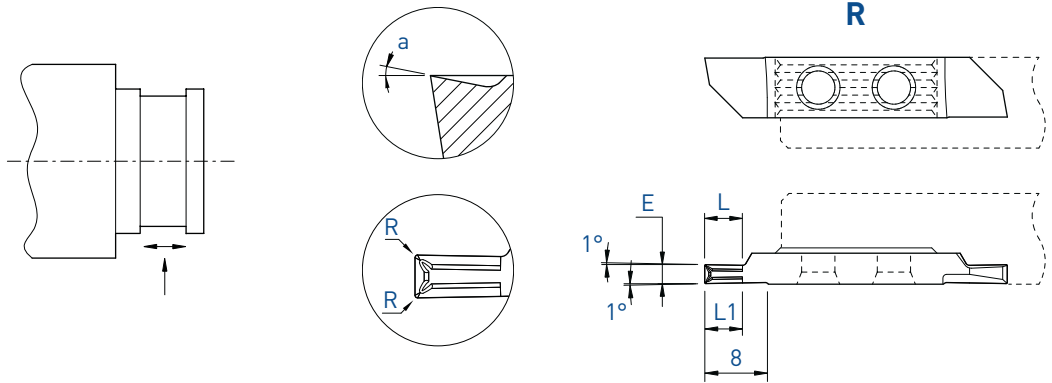

a	E	L	L1	R	Art. N°	TiAlN	TiAlX	LoX	TiN	N (µm20)
10°	1.5	4	4	0.08	764ZXB10-1.5-R08	■	■	■	□	
	2.0	4	4	0.08	764ZXB10-2.0-R08	■	■	■	□	
	2.0	4	4	0.15	764ZXB10-2.0-R15	■	■	■	□	
	2.0	4	4	0.35	764ZXB10-2.0-R35	■	■	■	□	
	2.5	5	5	0.08	764ZXB10-2.5-R08	■	■	■	□	
	2.5	5	5	0.15	764ZXB10-2.5-R15	■	■	■	□	
	2.5	5	5	0.35	764ZXB10-2.5-R35	■	■	■	□	
	3.0	6	6	0.08	764ZXB10-3.0-R08	■	■	■	□	
	3.0	6	6	0.15	764ZXB10-3.0-R15	■	■	■	□	
	3.0	6	6	0.35	764ZXB10-3.0-R35	■	■	■	□	

7XX-XX-B

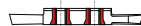

Sur demande pour serrage type B, voir page 1.03
 Wahlweise mit B-Spannsystem, siehe Seite 1.03
 On request for B clamping system, see page 1.03

■ = disponible / verfügbar / available

□ = selon disponibilité du stock / jenach Lagerverfügbarkeit / depending on stock availability

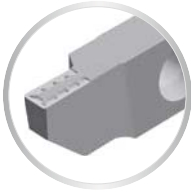
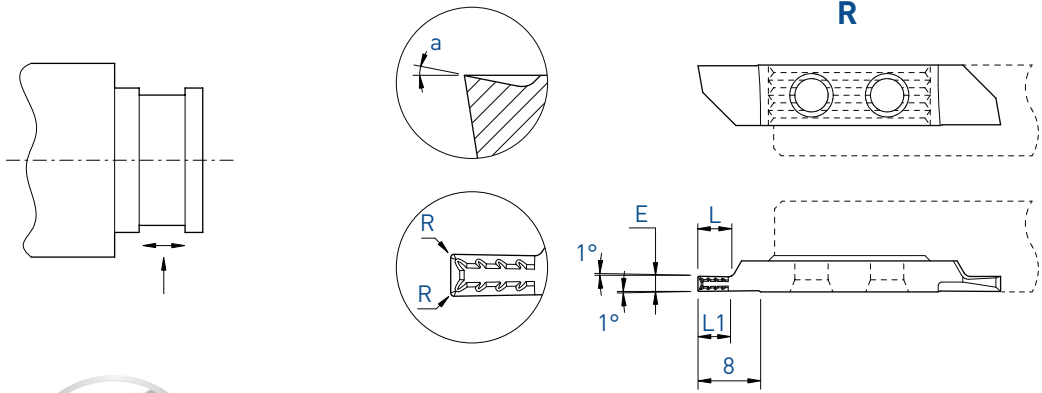

Pour un meilleur contrôle des copeaux
Für eine bessere Spankontrolle
For a better chip-control

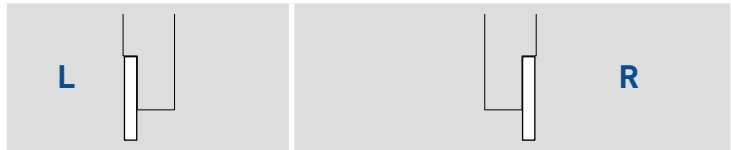

a	E	L	L1	R	Art. N°	TiAlN			Art. N°	TiAlN				HTA	HN (µk10)
						TiN	N (µk20)	TiAlX		LOX	TiN	N (µk20)			
10°	1.5	4	4	0.03	-				764ZXT10-1.5-R03	■	■	■	□		
	1.5	4	4	0.08	754ZXT10-1.5-R08	■	□		764ZXT10-1.5-R08	■	■	■	□		
	1.5	4	4	0.20	754ZXT10-1.5-R20	■			-						
	2.0	4	4	0.08	754ZXT10-2.0-R08	■	□		764ZXT10-2.0-R08	■	■	■	□		
	2.0	4	4	0.20	754ZXT10-2.0-R20	■			764ZXT10-2.0-R20	■	■	■	□		
	2.0	4	4	0.40	-				764ZXT10-2.0-R40	■	■	■			
	2.5	5	5	0.08	754ZXT10-2.5-R08	■	□		764ZXT10-2.5-R08	■	■	■	□		
	2.5	5	5	0.20	754ZXT10-2.5-R20	■			764ZXT10-2.5-R20	■	■	■	□		
	2.5	5	5	0.40	-				764ZXT10-2.5-R40	■	■	■			
	3.0	6	6	0.08	754ZXT10-3.0-R08	■	□		764ZXT10-3.0-R08	■	■	■	□		
	3.0	6	6	0.20	-				764ZXT10-3.0-R20	■	■	■	□	■	
	3.0	6	6	0.40	-				764ZXT10-3.0-R40	■	■	■	□		
	4.0	8	8	0.20	-				764ZXT10-4.0-R20	■	■	■	□		
	4.0	8	8	0.40	-				764ZXT10-4.0-R40	■	■	■	□		
4.0	8	8	0.80	-				764ZXT10-4.0-R80	■	■	■				

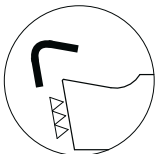

Arête de coupe honée
Gehonte Schneidkante
Honed edge

f min: 0.02 mm/U



7XX-XX-B
Sur demande pour serrage type B, voir page 1.03
Wahlweise mit B-Spannsystem, siehe Seite 1.03
On request for B clamping system, see page 1.03

Filetage

Gewinde drehen

Threading

756 / 766

L

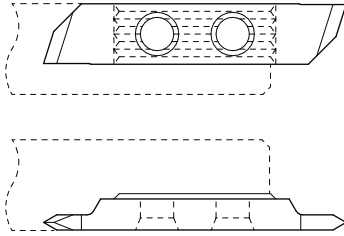

R

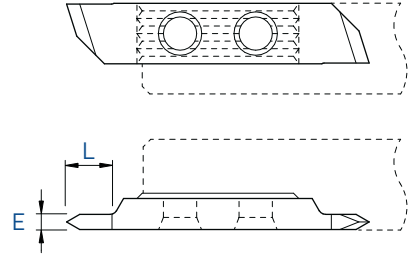

L

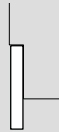

R

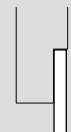

W	E	L	R	Art. N°	TiAlN	TiN	N (µk20)	HTA	HTiN	HN (µk10)	Art. N°	TiAlN	TiN	N (µk20)	HTA	HTiN	HN (µk10)
60°	2.0	6	-	756-60-2.0	■	■	■				766-60-2.0	■	■	■			
60°	2.0	6	0.02	756-60-2.0-R02	■	■	■	■	□	■	766-60-2.0-R02	■	■	■	■	□	■
60°	3.0	8	-	756-60-3.0	■	■	■				766-60-3.0	■	■	■			
60°	3.0	8	0.02	756-60-3.0-R02	■	■	■	■	□	■	766-60-3.0-R02	■	■	■	■	□	■
55°	2.0	6	-	756-55-2.0	■	■	■				766-55-2.0	■	■	■			
55°	2.0	6	0.02	756-55-2.0-R02	■	■	■				766-55-2.0-R02	■	■	■			
55°	3.0	8	-	756-55-3.0	■	■	■				766-55-3.0	■	■	■			
55°	3.0	8	0.02	756-55-3.0-R02	■	■	■				766-55-3.0-R02	■	■	■			

7XX-XX-B



Sur demande pour serrage type B, voir page 1.03
Wahlweise mit B-Spannsystem, siehe Seite 1.03
On request for B clamping system, see page 1.03

■ = disponible / verfügbar / available
□ = selon disponibilité du stock / jenach Lagerverfügbarkeit / depending on stock availability

- Filetage
- Gewinde drehen
- Threading

756-AG60° / 766-AG60°
756-G60° / 766-G60°

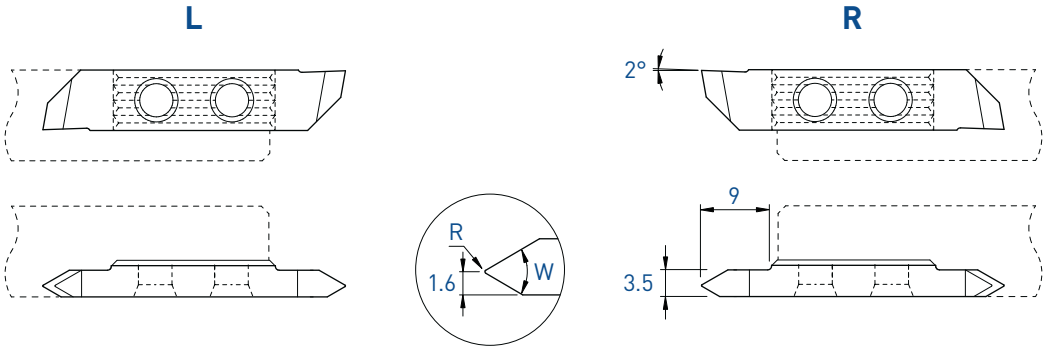

Profil partiel
Teilprofil
Partial profile

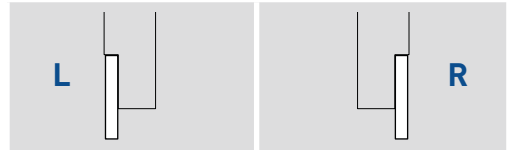

			L			R				
W	R	Pas Steigung Pitch P	Art. N°	TiAIN	TiN	N (µk20)	Art. N°	TiAIN	TiN	N (µk20)
60°	0.06	0.50-1.50	756-AG60°	■	■	■	766-AG60°	■	■	■
60°	0.20	1.75-3.00	756-G60°	■	■	■	766-G60°	■	■	■

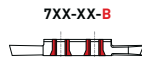

7XX-XX-B Sur demande pour serrage type B, voir page 1.03
Wahlweise mit B-Spannsystem, siehe Seite 1.03
On request for B clamping system, see page 1.03

Filetage
Gewinde drehen
Threading

756-M / 766-M

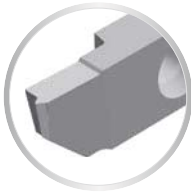
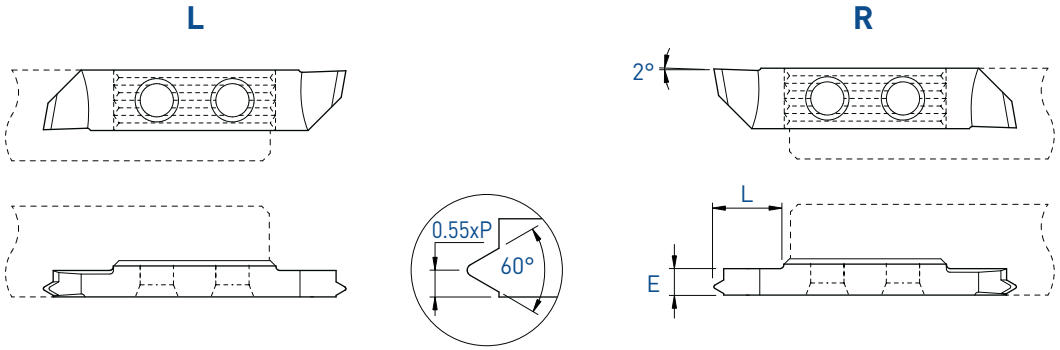

Profil complet métrique
Metrisches Vollprofil
Metric full profile

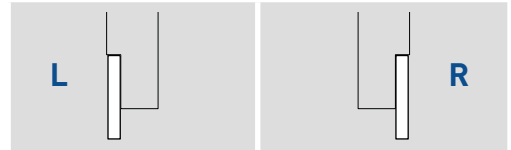

E	L	Pas Steigung Pitch P	L			R				
			Art. N°	TiAIN	TiN	N (µk20)	Art. N°	TiAIN	TiN	N (µk20)
2.5	8	0.80	756-M-0.80	■	■	■	766-M-0.80	■	■	■
2.5	8	1.00	756-M-1.00	■	■	■	766-M-1.00	■	■	■
2.5	8	1.25	756-M-1.25	■	■	■	766-M-1.25	■	■	■
3.5	9	1.50	756-M-1.50	■	■	■	766-M-1.50	■	■	■
3.5	9	1.75	756-M-1.75	■	■	■	766-M-1.75	■	■	■
3.5	9	2.00	756-M-2.00	■	■	■	766-M-2.00	■	■	■

Pour de plus petits pas, voir page 1.65
Für kleinere Steigungen, siehe Seite 1.65
For smaller pitches, see page 1.65

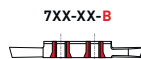

Sur demande pour serrage type B, voir page 1.03
Wahlweise mit B-Spannsystem, siehe Seite 1.03
On request for B clamping system, see page 1.03

■ = disponible / verfügbar / available
□ = selon disponibilité du stock / jenach Lagerverfügbarkeit / depending on stock availability

L

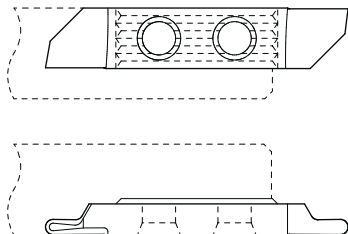

R

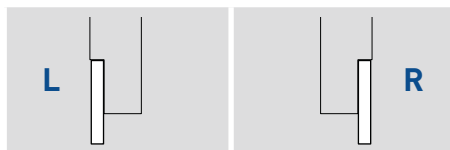
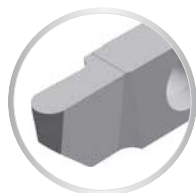
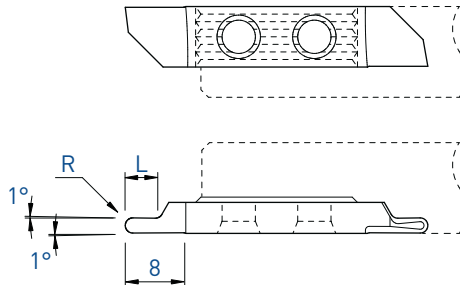

R	L	Art. N°	TiAlN			Art. N°	TiN		
			Ti	Al	N		Ti	Al	N
0.5	2.5	757-R0.5	■	■	■	767-R0.5	■	■	■
1.0	4	757-R1.0	■	■	■	767-R1.0	■	■	■
1.5	6	757-R1.5	■	■	■	767-R1.5	■	■	■
2.0	8	757-R2.0	■	■	■	767-R2.0	■	■	■

7XX-XX-B



Sur demande pour serrage type B, voir page 1.03
 Wahlweise mit B-Spannsystem, siehe Seite 1.03
 On request for B clamping system, see page 1.03

Plaquettes à rayon
 Radius Wendeplatten
 Radius inserts

757ZX10 / 767ZX10

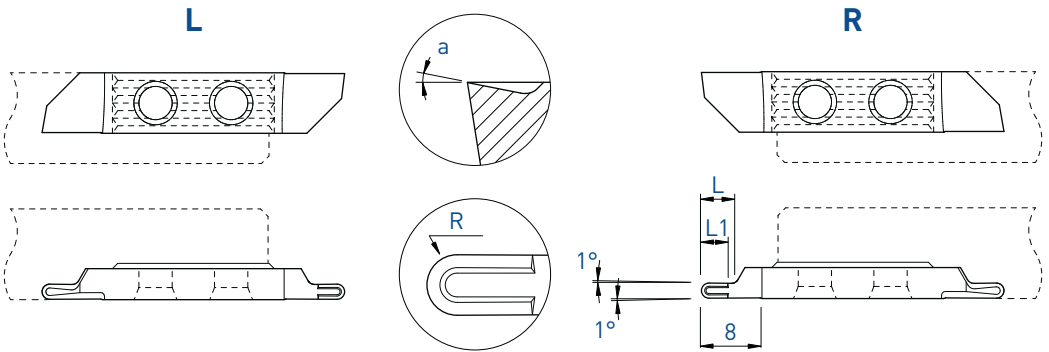

Pour un meilleur contrôle des copeaux
 Für eine bessere Spankontrolle
 For a better chip-control



a	R	L	L1	L			R						
				Art. N°	TiAlN	TiN	N (µk20)	Art. N°	TiAlN	TiN	N (µk20)	HTA	N (µk20)
10°	1.0	4	3.5	757ZX10-R1.0	■	□		767ZX10-R1.0	■	□			
	1.5	6	4.0	757ZX10-R1.5	■	□		767ZX10-R1.5	■	□			
	2.0	8	4.5	757ZX10-R2.0	■	□		767ZX10-R2.0	■	□	■		

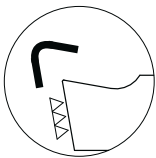

Arête de coupe honée
 Gehonte Schneidkante
 Honed edge

f min: 0.02 mm/U

7XX-XX-B



Sur demande pour serrage type B, voir page 1.03
 Wahlweise mit B-Spannsystem, siehe Seite 1.03
 On request for B clamping system, see page 1.03

L

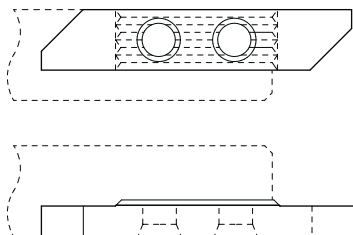

7XX-XX-B



Sur demande pour serrage type B, voir page 1.03
Wahlweise mit B-Spannsystem, siehe Seite 1.03
On request for B clamping system, see page 1.03

R

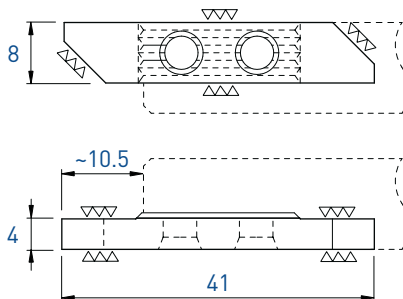

L		R			
Art. N°	N (µk20)	HN (µk10)	Art. N°	N (µk20)	HN (µk10)
751-E	■	■	761-E	■	■

L

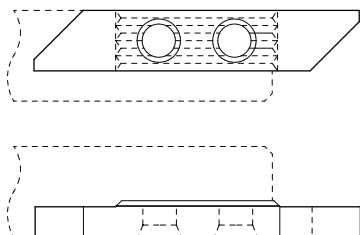

Face de coupe polie
Polierte Schneidfläche
Polished cutting face

R

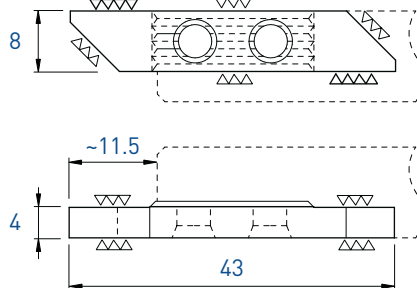

L					R								
Art. N°	TiAlN	TiN	N (µk20)	HTA	HTiN	HN (µk10)	Art. N°	TiAlN	TiN	N (µk20)	HTA	HTiN	HN (µk10)
751-EP	■	■	■	□	□	■	761-EP	■	■	■	■	□	■

■ = disponible / verfügbar / available

□ = selon disponibilité du stock / jenach Lagerverfügbarkeit / depending on stock availability

770 / 780

Tronçonnage de grande capacité
Abstechen für grössere Durchmesser
High capacity parting

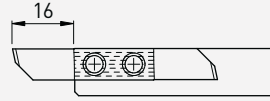
> **1.132****7050 / 7060**

Tronçonnage de grande capacité
Abstechen für grössere Durchmesser
High capacity parting

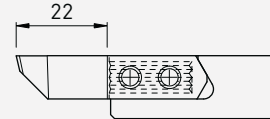
> **1.142****W750 / W760**

Outils avec plaquettes ébauches larges pour profilage
Werkzeuge mit breiten WSP-Rohlingen für Profilschleifen
Tools with wide blank inserts for profiling

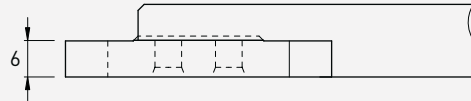
> **1.148**

Porte-outils spécifiques / Spezifische Werkzeughalter / Specific tool holders

POLYGONAL INTERFACE C3 / C4 - HSK> **1.152****740Z / 760Z**

Porte-outils pour usinage déporté
Halter für versetzte Bearbeitung
Holders for shifted machining

> **1.155****DECO 7/10 - EvoDECO 10****R**> **1.156****DECO 7/10 - EvoDECO 10****L**> **1.158****Tornos****DECO 13 - EvoDECO 16****DECO 20/26 - EvoDECO 20/32**> **1.160****MultiSwiss 6x16**> **1.162****AS14 / SAS16**> **1.163****Schütte**> **1.164**

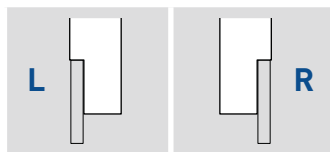
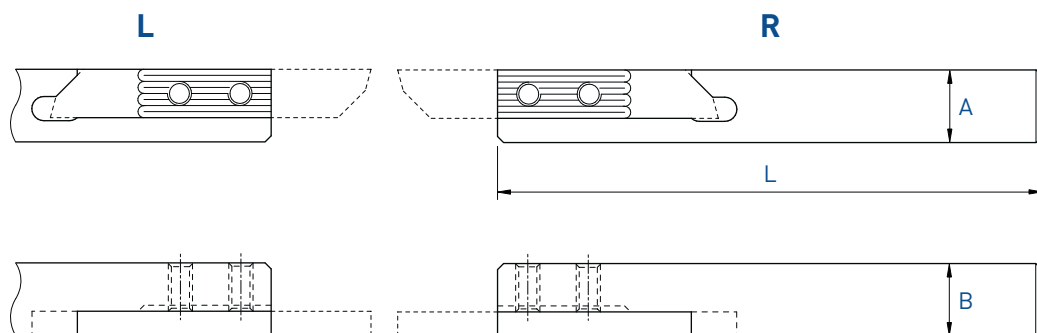

A x B	L	Serrage Spannsystem Clamping	Art. N°	Art. N°
10 x 10	115	A	770-10	780-10
12 x 12	130	A	770-12	780-12
12 x 12	90	A	770-12-90	780-12-90
12.7 x 12.7	130	A	770-12.7	780-12.7
14 x 14	130	A	770-14	780-14
16 x 16	130	A	770-16	780-16
16 x 16	75	A	770-16-75	780-16-75
20 x 20	120	A	770-20	780-20
25 x 25	140	A	770-25	780-25

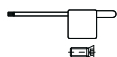

Chaque support est livré avec vis et clé.
 Jeder Halter wird mit Spannschraube(n) und Schlüssel geliefert.
 Screw(s) and key are included with each tool holder.

Porte-outils avec arrosage intégré
 Halter mit integrierter Kühlmittelzufuhr
 Holders with integrated coolant supply

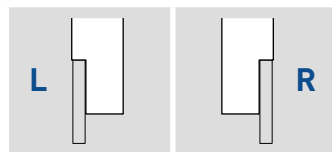
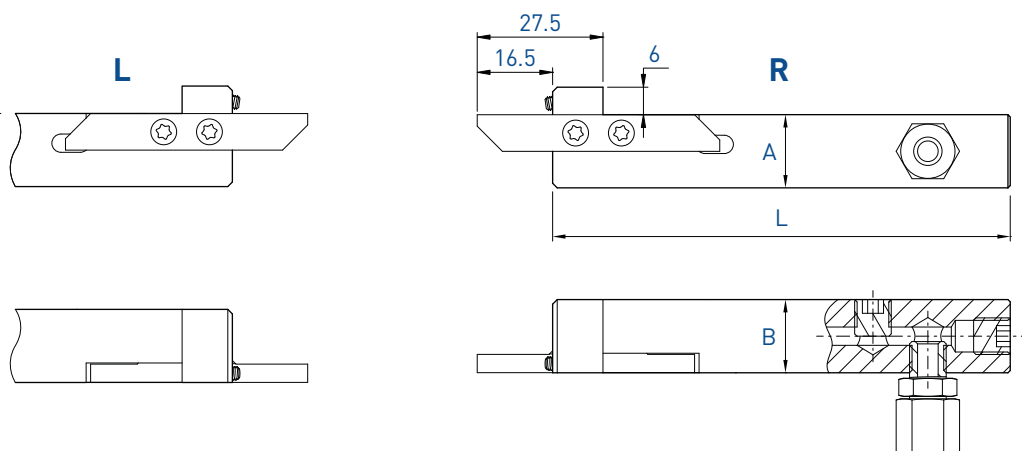

770-JET / 780-JET

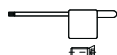

A x B	L	Serrage Spannsystem Clamping	Art. N°	Art. N°
16 x 16	100	A	770-16-JET	780-16-JET

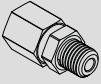

Chaque support est livré avec vis et clé.
 Jeder Halter wird mit Spannschraube(n)
 und Schlüssel geliefert.
 Screw(s) and key are included with each
 tool holder.

Pièces de rechange Ersatzteile Spare parts			Buse Düse Nozzle 
	Art. N°	Art. N°	Art. N°
770-JET / 780-JET	J-M8X1-D6	JB-M8X1	JJ-M3X6-D1.5

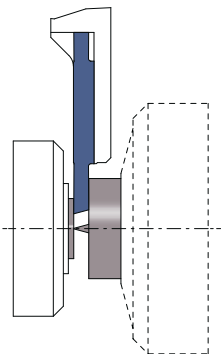
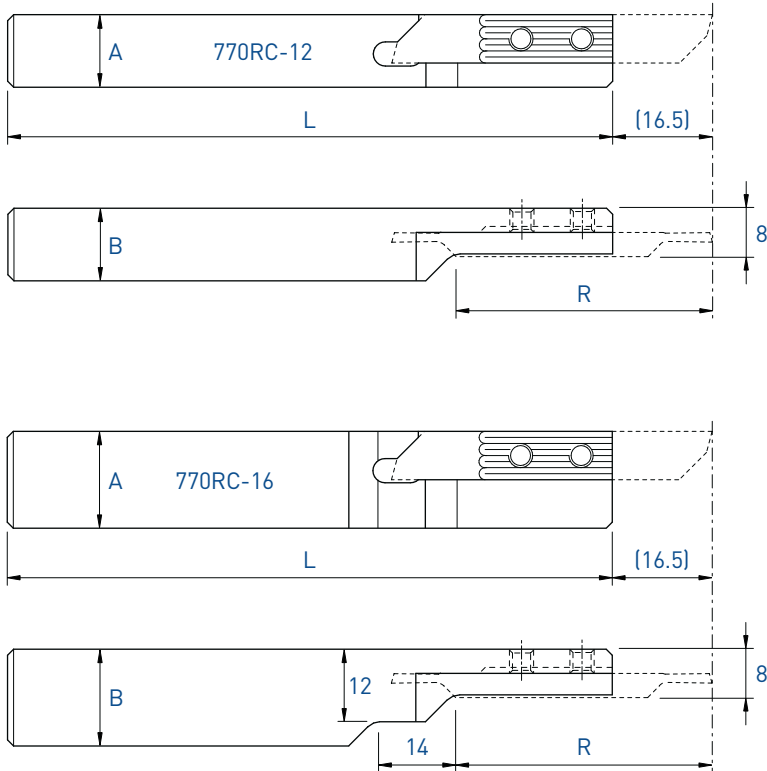

Utiliser des plaquettes type 771R
 WSP Typ 771R verwenden
 Use inserts type 771R

Voir pages 1.137 - 1.140
 Siehe Seiten 1.137 - 1.140
 See pages 1.137 - 1.140

 L (R) Coupe à droite déportée Versetztes Rechtsschneiden Right cut off line				
A x B	L	R	Serrage Spannsystem Clamping	Art. N°
12 x 12	130	42	A	770RC-12
16 x 16	130	42	A	770RC-16



Chaque support est livré avec vis et clé.
 Jeder Halter wird mit Spannschraube(n) und Schlüssel geliefert.
 Screw(s) and key are included with each tool holder.

Tronçonnage

Abstechen

Parting off

771 / 781

L

R

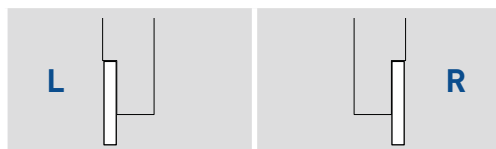
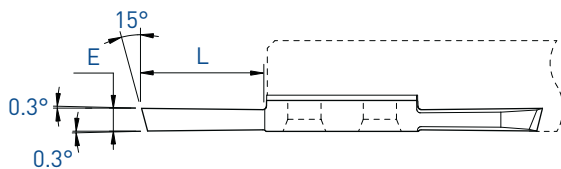
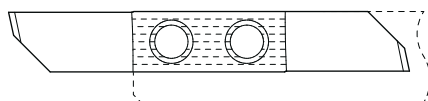
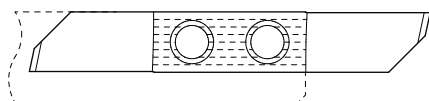

E	L	Art. N°	L			R			
			TiAlN	TiN	N (µk20)	Art. N°	TiAlN	TiN	N (µk20)
1.5	16	-				781-1.5	■	■	■
2.0	16	771-2.0	■	■	■	781-2.0	■	■	■
2.5	16	771-2.5	■	■	■	781-2.5	■	■	■
3.0	16	771-3.0	■	■	■	781-3.0	■	■	■
3.5	16	771-3.5	■	■	■	781-3.5	■	■	■

TOP-LINE

- Tronçonnage
- Abstechen
- Parting off

771XF / 781XF

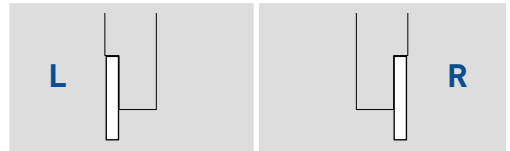
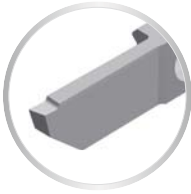
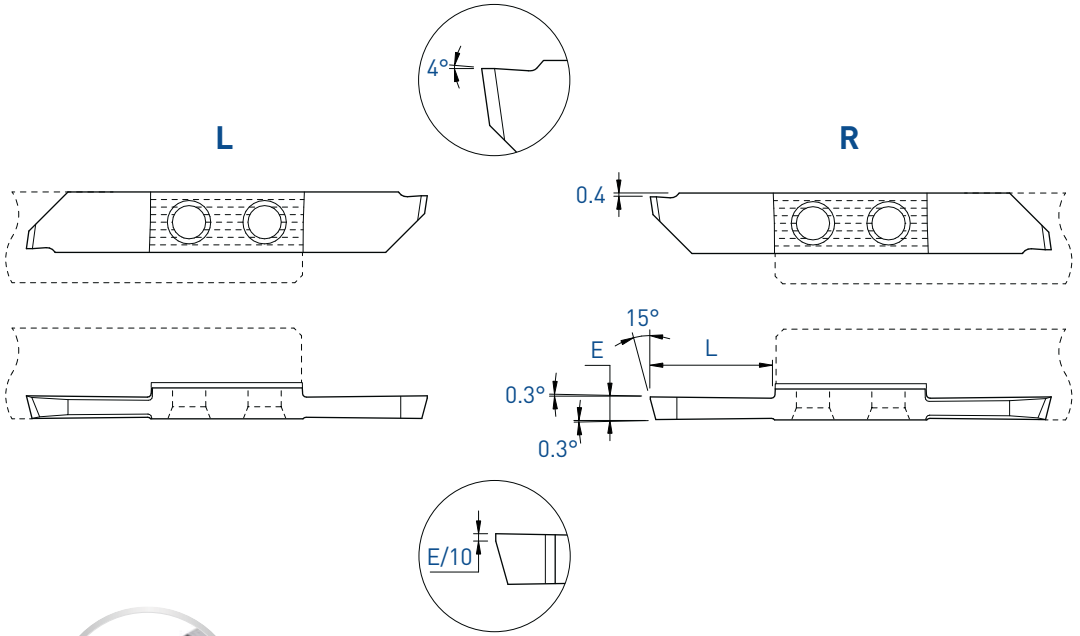

E	L	L			R				
		Art. N°	TiAlN	TiN	N (µk20)	Art. N°	TiAlN	TiN	N (µk20)
2.0	16	-				781XF-2.0	■	■	■
2.5	16	771XF-2.5	■	■	■	781XF-2.5	■	■	■
3.0	16	771XF-3.0	■	■	■	781XF-3.0	■	■	■
3.5	16	771XF-3.5	■	■	■	781XF-3.5	■	■	■

Tronçonnage
Abstechen
Parting off

Coupe déportée
Versetztes Schneiden
Cut off line

781L / 771R

Cut R

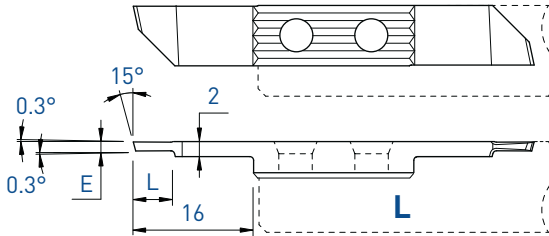

L (R)
Coupe à droite déportée
Versetztes Rechtsschneiden
Right cut off line

E	L	Art. N°	TiAlN	TiN	N (µk20)
1.0	5	771R-1.0	■	■	■
1.2	5	771R-1.2	■	■	■
1.5	8.5	771R-1.5	■	■	■

Cut L

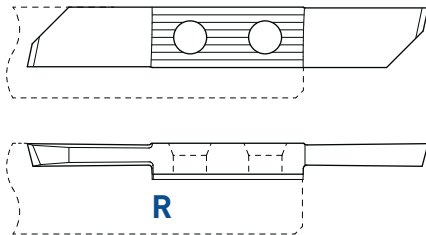

Cut R

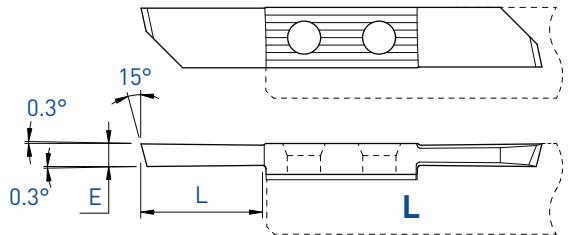

R (L)
Coupe à gauche déportée
Versetztes Linksschneiden
Left cut off line

L (R)
Coupe à droite déportée
Versetztes Rechtsschneiden
Right cut off line

E	L	Art. N°	TiAlN	TiN	N (µk20)	Art. N°	TiAlN	TiN	N (µk20)
2.0	16	781L-2.0	■	■	■	771R-2.0	■	■	■
2.5	16	781L-2.5	■	■	■	771R-2.5	■	■	■
3.0	16	781L-3.0	■	■	■	771R-3.0	■	■	■
3.5	16	781L-3.5	■	■	■	771R-3.5	■	■	■

■ = disponible / verfügbar / available
□ = selon disponibilité du stock / jenach Lagerverfügbarkeit / depending on stock availability

Tronçonnage

Abstechen

Parting off

Coupe déportée

Versetztes Schneiden

Cut off line

771RU

Cut R

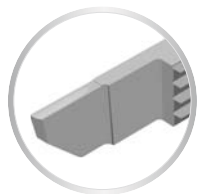
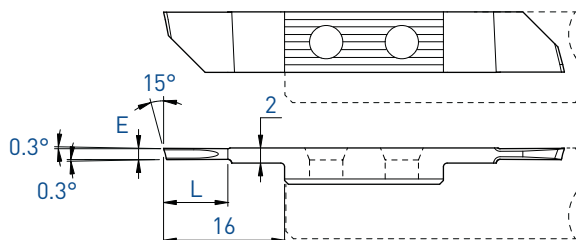

L (R)

Coupe à droite déportée
Versetztes Rechtsschneiden
Right cut off line

E	L	Art. N°	TiAlN	TiN	N (µk20)
1.0	5	771RU-1.0	■	□	■
1.5	8.5	771RU-1.5	■	□	■

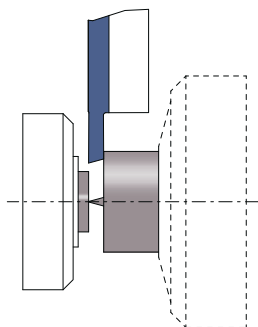

Tronçonnage
Abstechen
Parting off

Coupe déportée
Versetztes Schneiden
Cut off line

781LXF / 771RXF

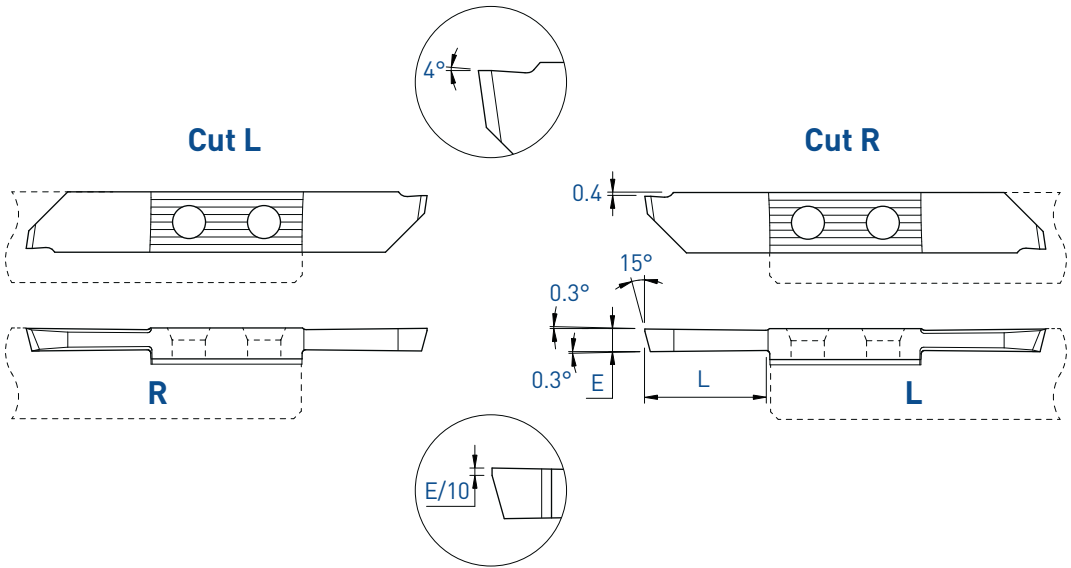

R (L)				L (R)			
Coupe à gauche déportée Versetztes Linksschneiden Left cut off line				Coupe à droite déportée Versetztes Rechtsschneiden Right cut off line			

E	L	Art. N°	TiAlN	TiN	N (µk20)	Art. N°	TiAlN	TiN	N (µk20)
2.0	16	-				771RXF-2.0	■	■	■
2.5	16	781LXF-2.5	■	■	■	771RXF-2.5	■	■	■
3.0	16	781LXF-3.0	■	■	■	771RXF-3.0	■	■	■
3.5	16	781LXF-3.5	■	■	■	771RXF-3.5	■	■	■

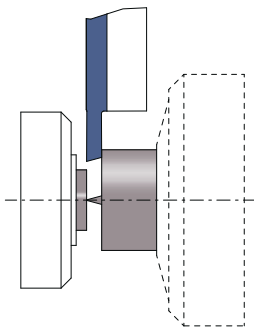

Tronçonnage
Abstechen
Parting off

Coupe déportée
Versetztes Schneiden
Cut off line

771RD

Cut R

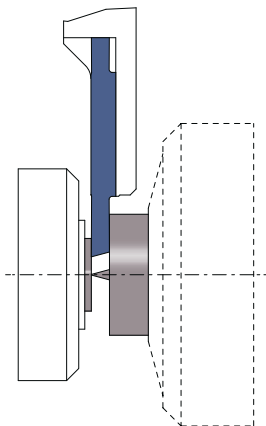
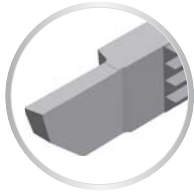
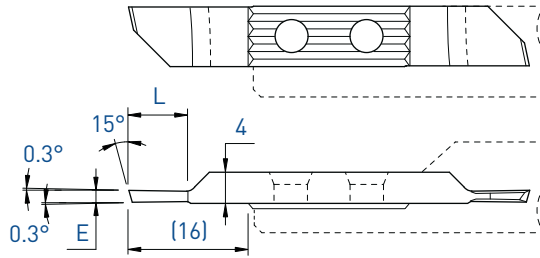

L (R)

Coupe à droite déportée
Versetztes Rechtsschneiden
Right cut off line

E	L	Art. N°	TiAlN	TiN	N (µk20)
1.2	5	771RD-1.2	■	■	■
1.5	7.5	771RD-1.5	■	■	■
2.0	10	771RD-2.0	■	■	■

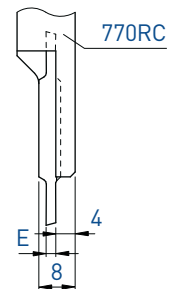

Plaquettes ébauches

WSP-Rohlinge

Blank inserts

771-E / 781-E

L

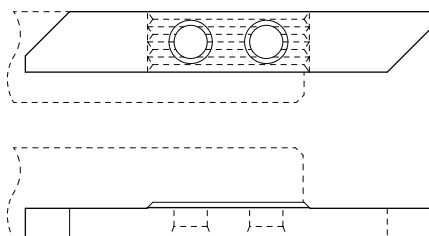

R

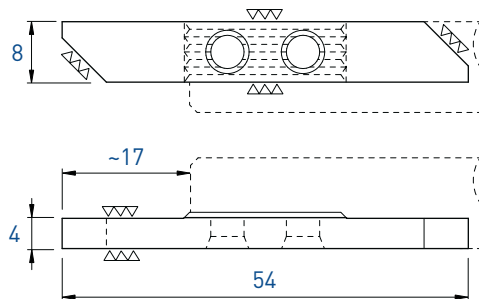

L		R	
Art. N°	N (µk20)	Art. N°	N (µk20)
771-E	■	781-E	■

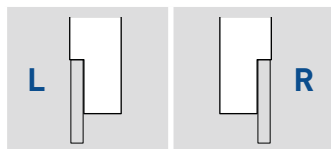
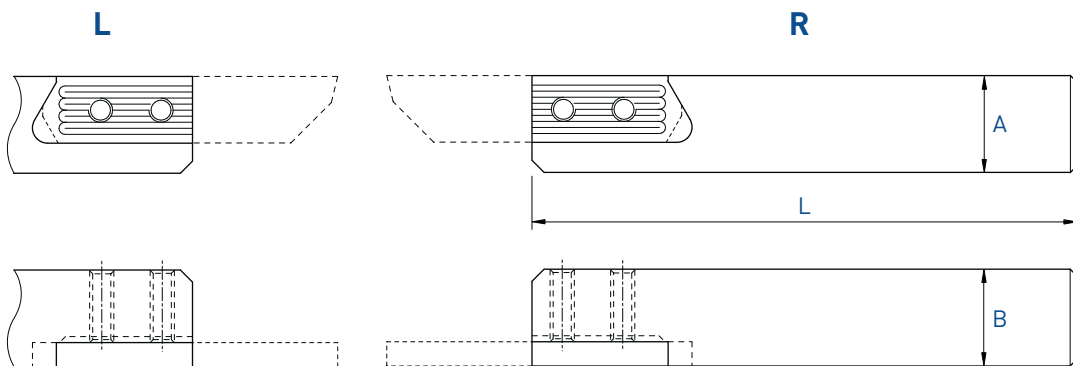

A x B	L	Serrage Spannsystem Clamping	Art. N°	Art. N°
16 x 16	130	A	7050-16	7060-16
16 x 16	75	A	7050-16-75	7060-16-75
20 x 20	120	A	7050-20	7060-20
25 x 25	140	A	7050-25	7060-25



Chaque support est livré avec vis et clé.
Jeder Halter wird mit Spannschraube(n) und Schlüssel geliefert.
Screw(s) and key are included with each tool holder.

Tronçonnage

Abstechen

Parting off

7051 / 7061

L

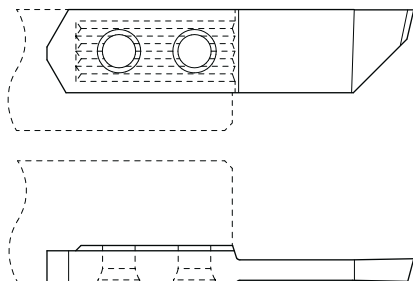

R

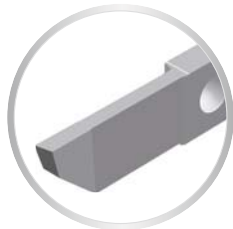
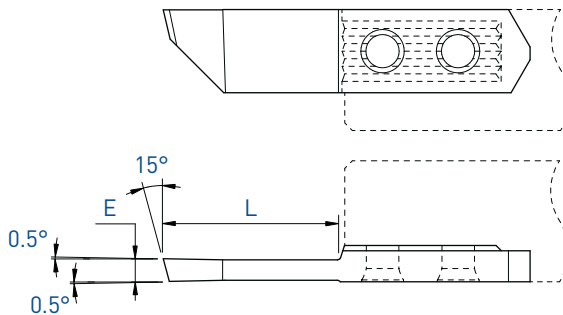

L

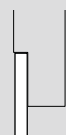

R



E	L	Art. N°	TiAlN	TiN	N [µk20]	Art. N°	TiAlN	TiN	N [µk20]
2.5	22	-				7061-2.5	■	■	■
3.0	22	7051-3.0	■	■	■	7061-3.0	■	■	■
3.5	22	-				7061-3.5	■	■	■

TOP-LINE

Tronçonnage
Abstechen
Parting off

7051XF / 7061XF

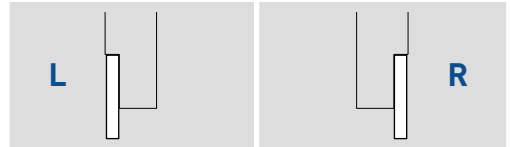
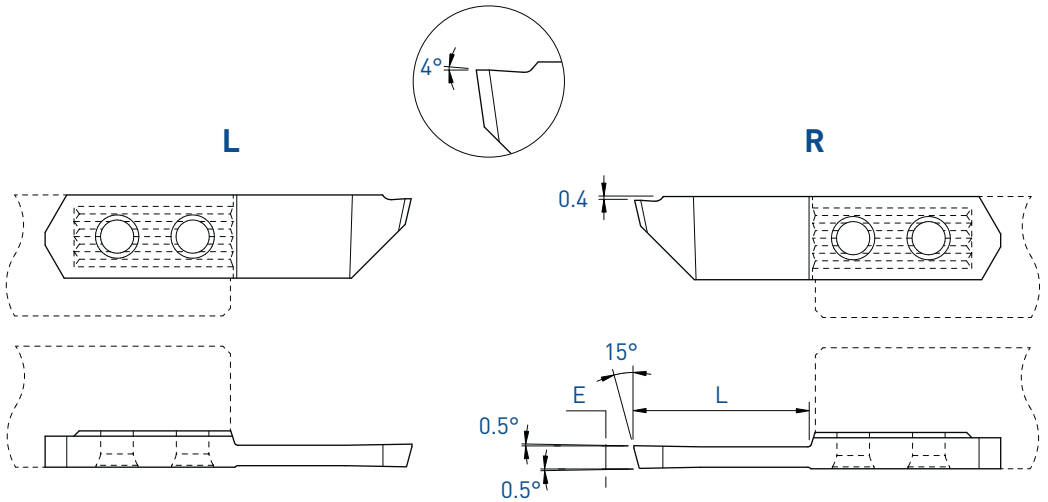

E	L	Art. N°	TiAlN	TiN	N (µk20)	Art. N°	TiAlN	TiN	N (µk20)
3.0	22	7051XF-3.0	■	■	■	7061XF-3.0	■	■	■

Tronçonnage
Abstechen
Parting off

Coupe déportée
Versetzttes Schneiden
Cut off line

7061L / 7051R

Cut L

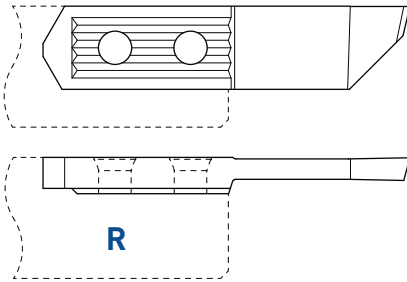

Cut R

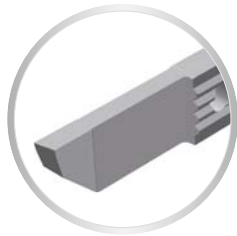
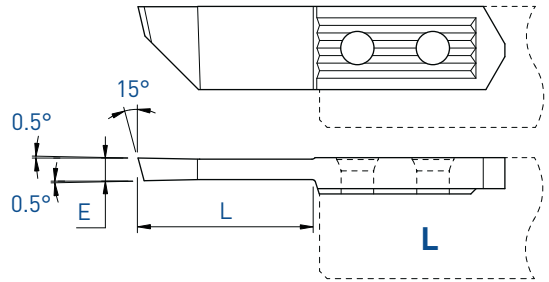

R (L)

Coupe à gauche déportée
Versetzttes Linksschneiden
Left cut off line

L (R)

Coupe à droite déportée
Versetzttes Rechtsschneiden
Right cut off line

E	L	Art. N°	TiAlN	TiN	N (µk20)	Art. N°	TiAlN	TiN	N (µk20)
2.5	22	-				7051R-2.5	■	■	■
3.0	22	7061L-3.0	■	■	■	7051R-3.0	■	■	■
3.5	22	-				7051R-3.5	■	■	■

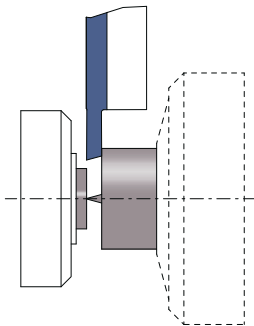

TOP-LINE

Tronçonnage
Abstechen
Parting off

Coupe déportée
Versetztes Schneiden
Cut off line

7061LXF / 7051RXF

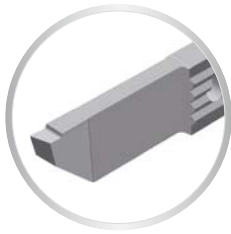
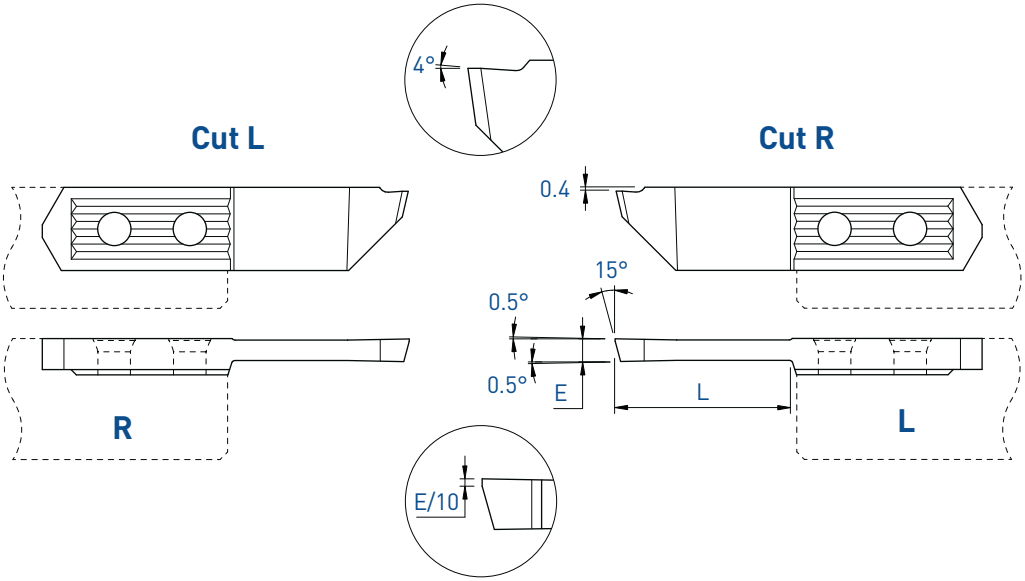

R (L)			L (R)		
Coupe à gauche déportée Versetztes Linksschneiden Left cut off line			Coupe à droite déportée Versetztes Rechtsschneiden Right cut off line		

E	L	Art. N°	TiAIN	TiN	N (µk20)	Art. N°	TiAIN	TiN	N (µk20)
3.0	22	7061LXF-3.0	■	■	■	7051RXF-3.0	■	■	■

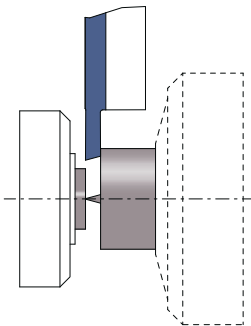

Plaquettes ébauches

WSP-Rohlinge

Blank inserts

7051-E / 7061-E

L

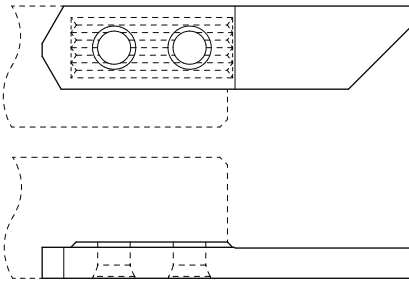

R

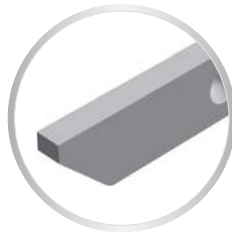
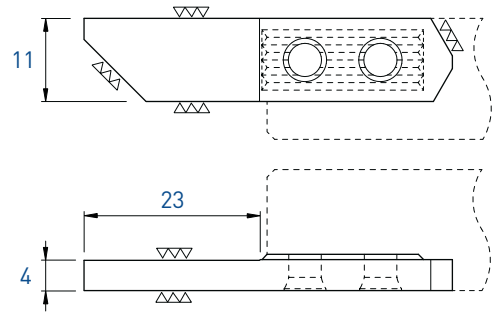

L		R	
Art. N°	N (µk20)	Art. N°	N (µk20)
7051-E	■	7061-E	■

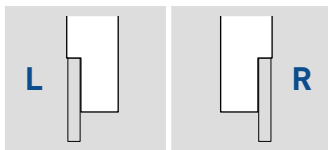
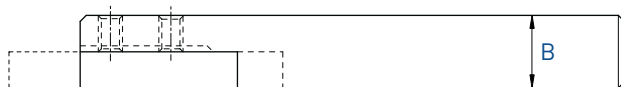
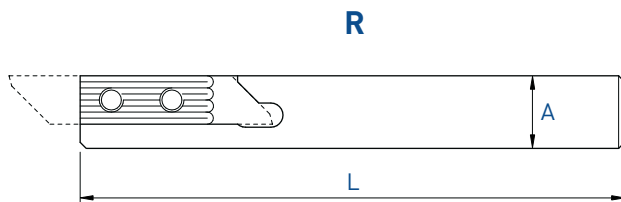
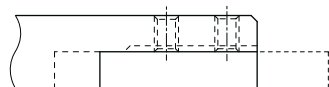
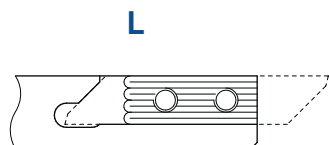

A x B	L	Serrage Spannsystem Clamping	Art. N°	Art. N°
12 x 12	130	A	W750-12	W760-12
16 x 16	130	A	W750-16	W760-16
20 x 20	120	A	W750-20	W760-20



Chaque support est livré avec vis et clé.
 Jeder Halter wird mit Spannschraube(n) und Schlüssel geliefert.
 Screw(s) and key are included with each tool holder.

Porte-outils avec arrosage intégré
 Halter mit integrierter Kühlmittelzufuhr
 Holders with integrated coolant supply

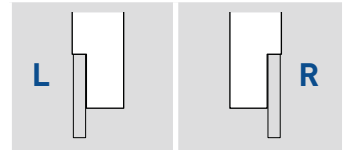
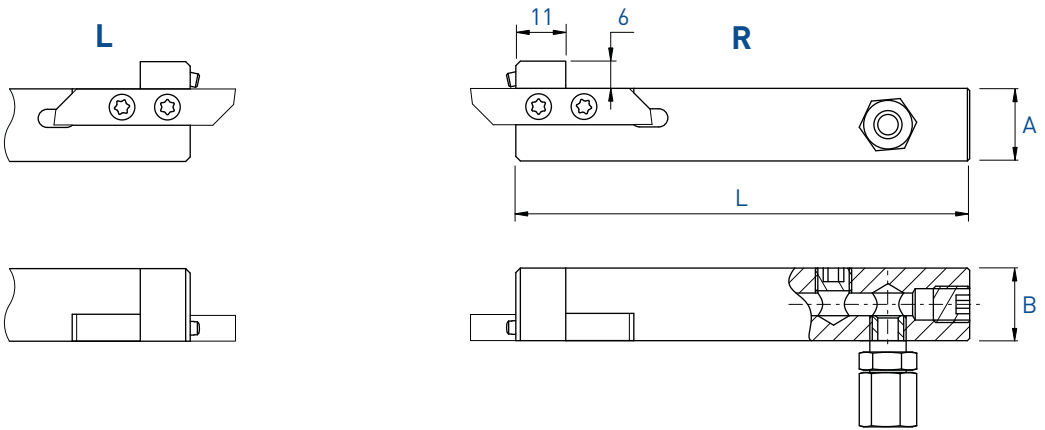

W750-JET / W760-JET

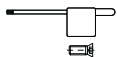

A x B	L	Serrage Spannsystem Clamping	Art. N°	Art. N°
16 x 16	100	A	W750-16-JET	W760-16-JET
20 x 20	100	A	W750-20-JET	W760-20-JET



Chaque support est livré avec vis et clé.
 Jeder Halter wird mit Spannschraube(n)
 und Schlüssel geliefert.
 Screw(s) and key are included with each
 tool holder.

Pièces de rechange Ersatzteile Spare parts			Buse Düse Nozzle 
	Art. N°	Art. N°	Art. N°
W750-JET / W760-JET	J-M8X1-D6	JB-M8X1	JJ-M3X6-D1.5

TOP-LINE

Plaquettes ébauches

WSP-Rohlinge

Blank inserts

W751-E5 / W761-E5 W751-EP5 / W761-EP5

L

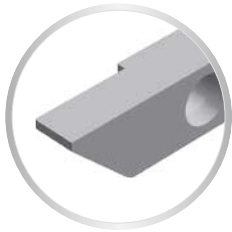
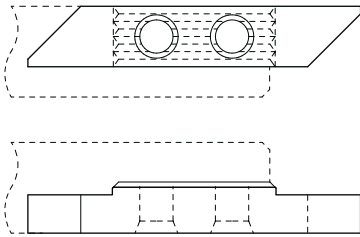

R

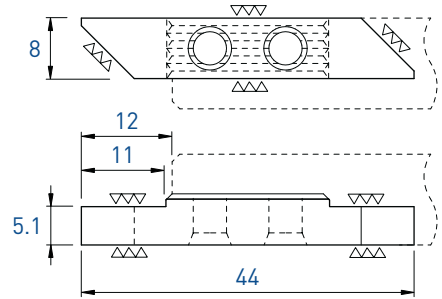

L		R	
Art. N°	N (µk20)	Art. N°	N (µk20)
W751-E5	■	W761-E5	■

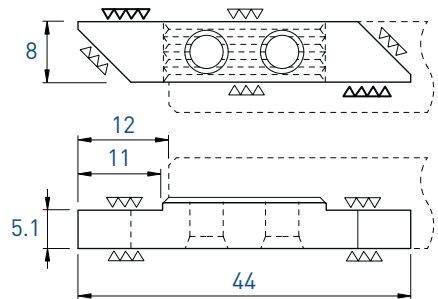
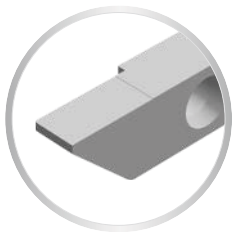
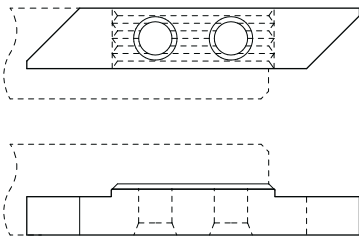

L		R	
Art. N°	N (µk20)	Art. N°	N (µk20)
W751-EP5	■	W761-EP5	■

Plaquettes ébauches

WSP-Rohlinge

Blank inserts

W751-E6 / W761-E6
W751-EP6 / W761-EP6

L

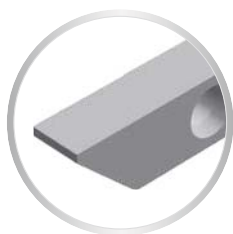
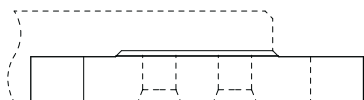
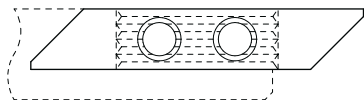

R

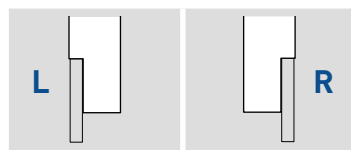
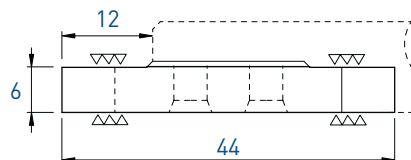
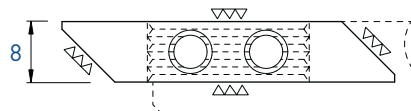

Art. N°	N (µk20)	Art. N°	N (µk20)
W751-E6	■	W761-E6	■

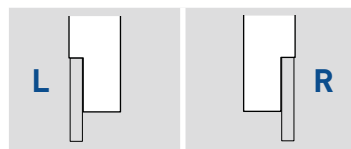
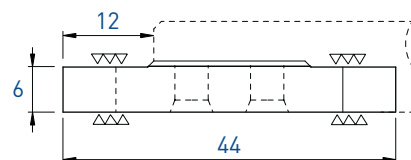
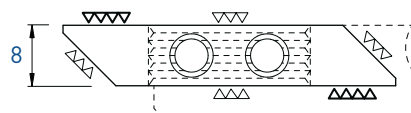
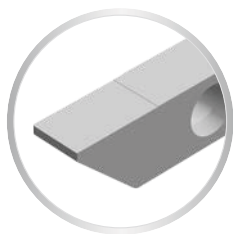
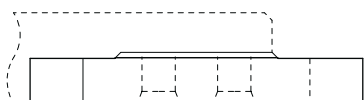
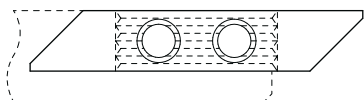

Art. N°	N (µk20)	Art. N°	N (µk20)
W751-EP6	■	W761-EP6	■

■ = disponible / verfügbar / available

□ = selon disponibilité du stock / jenach Lagerverfügbarkeit / depending on stock availability

Porte-outils

Halter

Holder

R

POLYGONAL INTERFACE C3 / C4

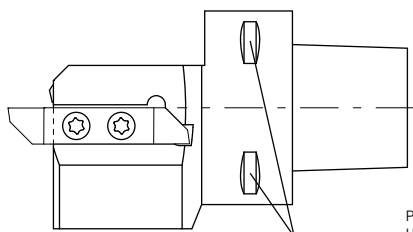
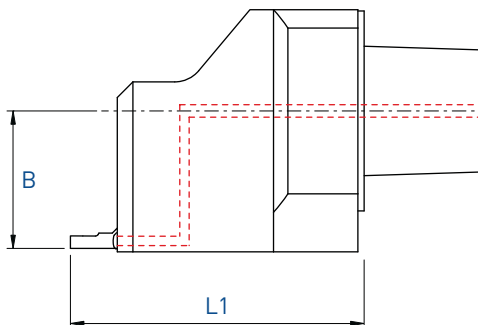
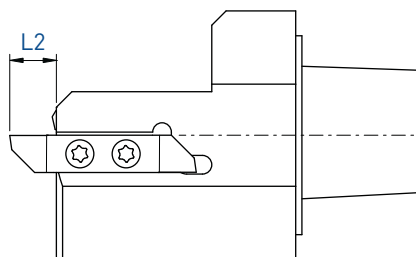

Porte-outils pour changeur automatique sur demande.
Halter für Werkzeugwechsler auf Anfrage.
Holder for tool changer on request.

Porte-outil Halter Holder	Plaquettes type WSP Typ Insert type	Pages Seiten Pages	L1	B	L2	Art. N°	Buse Düse Nozzle 
							Art. N°
C3	740	> 1.32	47	22	7.5	C3-740-22047	JJ-M3X6-D1.5
C3	760	> 1.78	47	22	10	C3-760-22047	JJ-M3X6-D1.5
C4	760	> 1.78	62	27	10	C4-760-27062	JJ-M3X6-D1.5

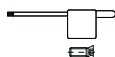

Chaque support est livré avec vis et clé.
Jeder Halter wird mit Spannschraube(n) und Schlüssel geliefert.
Screw(s) and key are included with each tool holder.

Porte-outils

Halter

Holders

L

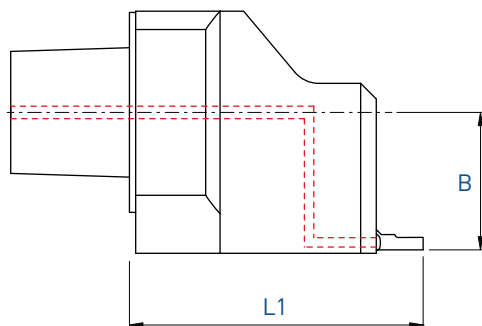
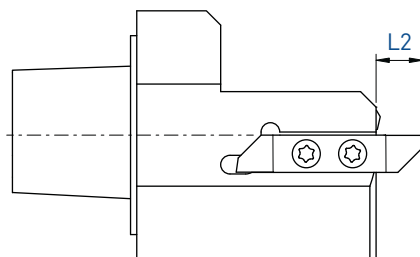
POLYGONAL INTERFACE
C4

Porte-outil Halter Holder	Plaquettes type WSP Typ Insert type	Pages Seiten Pages	L1	B	L2	Art. N°	Buse Düse Nozzle
							Art. N°
C4	750	> 1.78	62	27	10	C4-750-27062	JJ-M3X6-D1.5

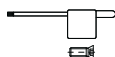

Chaque support est livré avec vis et clé.
Jeder Halter wird mit Spannschraube(n) und Schlüssel geliefert.
Screw(s) and key are included with each tool holder.

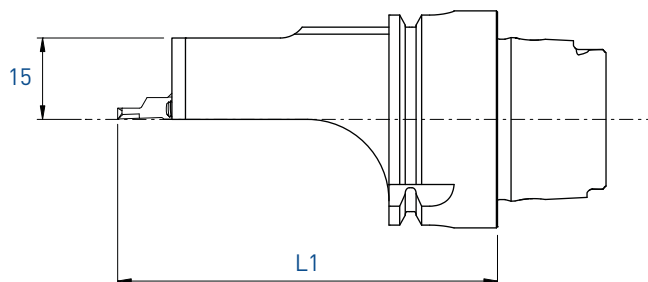
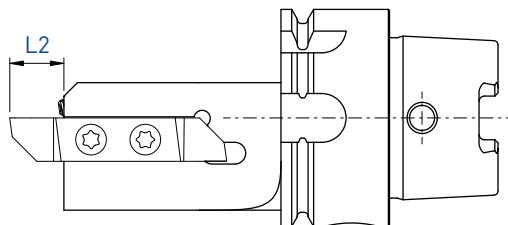

Utilisable sur toutes les machines avec broches HSK-T ou HSK-A

Auf allen Maschinen mit HSK-T oder HSK-A verwendbar

Applicable on all machines with HSK-T or HSK-A spindle

Plaquettes type WSP Typ Insert type	Pages Seiten Pages	L1	L2	Art. N°	Buse Düse Nozzle
					
					Art. N°
740	> 1.32	65	7.5	HSK-T40-740-0065-JET	JJ-M3X6-D1.5
760	> 1.78	70	10	HSK-T40-760-0070-JET	JJ-M3X6-D1.5

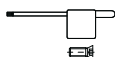

Chaque support est livré avec vis et clé.
Jeder Halter wird mit Spannschraube(n) und Schlüssel geliefert.
Screw(s) and key are included with each tool holder.

Porte-outils pour usinage déporté

Halter für versetzte Bearbeitung

Holders for shifted machining

R

740Z / 760Z

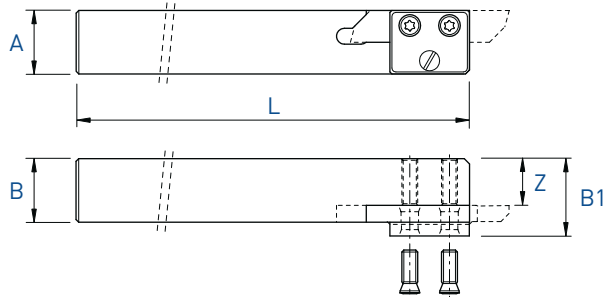
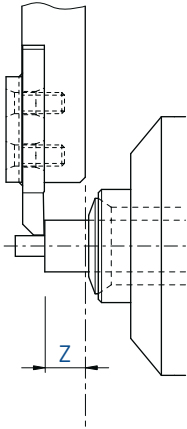
**740 Series**

A x B	L	Z	B1	Art. N°	Plaquettes type WSP Typ Inserts type	Pages Seiten Pages
12 x 12	130	9.5	14.5	740Z-12	741 - 747	> 1.32
16 x 16	130	13.5	18.5	740Z-16	741 - 747	> 1.32

760 Series

A x B	L	Z	B1	Art. N°	Plaquettes type WSP Typ Inserts type	Pages Seiten Pages
12 x 12	130	8	15	760Z-12	761 - 767	> 1.78
16 x 16	130	12	19	760Z-16	761 - 767	> 1.78

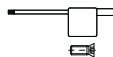

Chaque support est livré avec vis et clé.
Jeder Halter wird mit Spannschraube(n) und Schlüssel geliefert.
Screw(s) and key are included with each tool holder.

Coupe à droite
Rechtsschneiden
Right hand cut

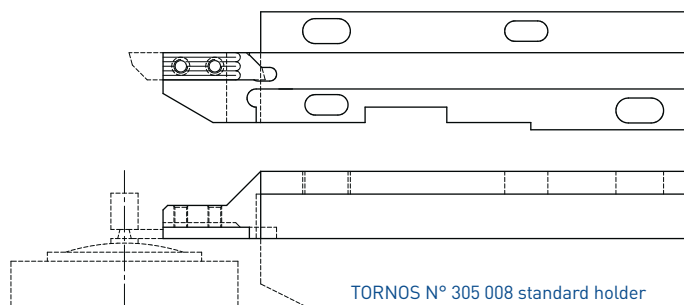

Art. N°	Plaquettes type WSP Typ Inserts type	Pages Seiten Pages
740-DECO10	741 - 747	> 1.32

Coupe à droite déportée
Versetztes Rechtsschneiden
Right cut off line

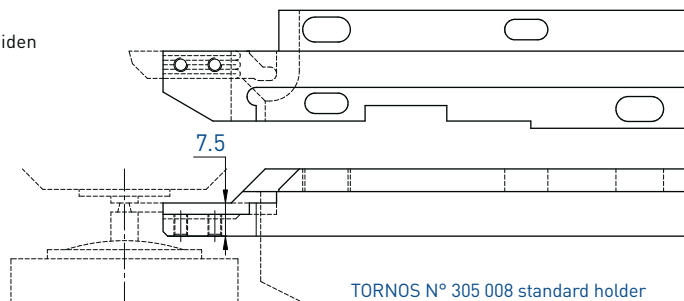

Art. N°	Plaquettes type WSP Typ Inserts type	Pages Seiten Pages
730R-DECO10	731R / 731N	1.39 - 1.45



Chaque support est livré avec vis et clé.
Jeder Halter wird mit Spannschraube(n) und Schlüssel geliefert.
Screw(s) and key are included with each tool holder.

Porte-outils pour machine Tornos

Halter für Tornos Maschine

Holder for Tornos machine

R

DECO 7/10
EvoDECO 10

Pour le tronçonnage de petites pièces
Zum Abstechen von kleinen Werkstücken
For small parts parting off



Réglable en longueur
Längseinstellbar
Adjustable length

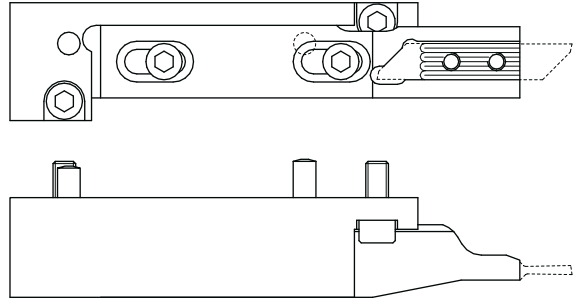

Art. N°	Plaquettes type WSP Typ Inserts type	Pages Seiten Pages
750R-DECO10	751R / 751N	1.88 - 1.99

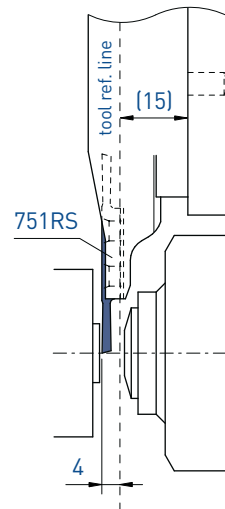
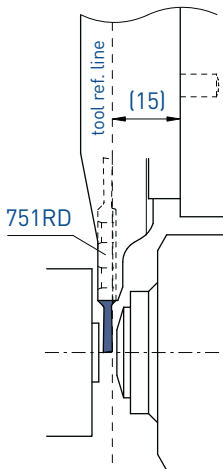

Chaque support est livré avec vis et clé.
Jeder Halter wird mit Spannschraub(e)n und Schlüssel geliefert.
Screw(s) and key are included with each tool holder.

Porte-outils pour machine Tornos

Halter für Tornos Maschine

Holders for Tornos machine

L

DECO 7/10
EvoDECO 10

Coupe à gauche
Linksschneiden
Left hand cut

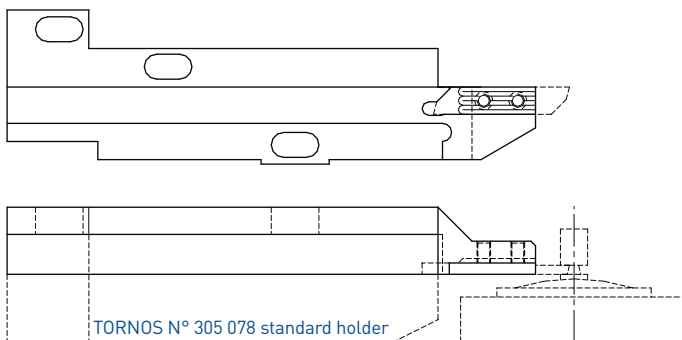

Art. N°	Plaquettes type WSP Typ Inserts type	Pages Seiten Pages
730-DECO10	731 - 737	> 1.32

Coupe à gauche déportée
Versetztes Linksschneiden
Left cut off line

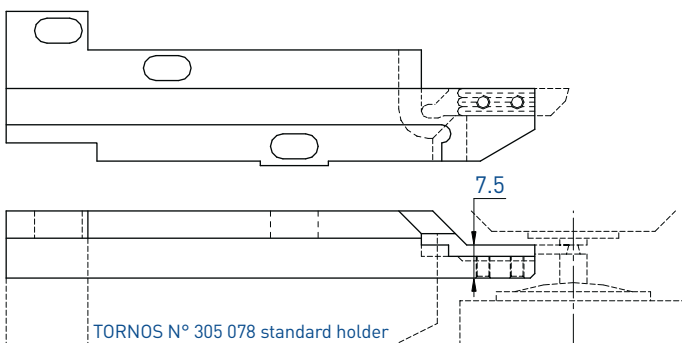

Art. N°	Plaquettes type WSP Typ Inserts type	Pages Seiten Pages
740L-DECO10	741L / 741N	1.39 - 1.45

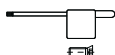

Chaque support est livré avec vis et clé.
Jeder Halter wird mit Spannschraub(en) und Schlüssel geliefert.
Screw(s) and key are included with each tool holder.

Porte-outils pour machine Tornos

Halter für Tornos Maschine

Holder for Tornos machine

L

DECO 7/10
EvoDECO 10

Pour le tronçonnage de petites pièces
Zum Abstechen von kleinen Werkstücken
For small parts parting off



Réglable en longueur
Längseinstellbar
Adjustable length

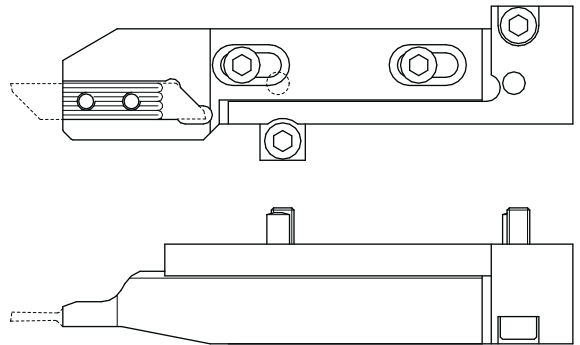

Art. N°	Plaquettes type WSP Typ Inserts type	Pages Seiten Pages
760L-DECO10	761L / 761N	1.88 - 1.98

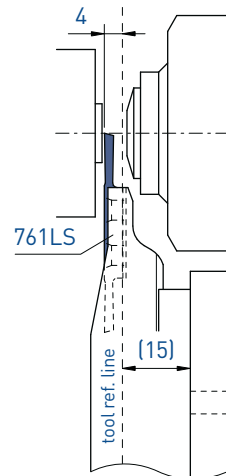
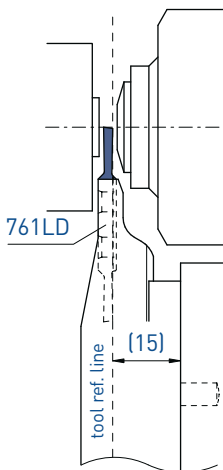

Chaque support est livré avec vis et clé.
Jeder Halter wird mit Spannschraubel(n) und Schlüssel geliefert.
Screw(s) and key are included with each tool holder.

Porte-outils pour machine Tornos

Halter für Tornos Maschine

Holders for Tornos machine

DECO 13
EvoDECO 16

Pour le tronçonnage de petites pièces
Zum Abstechen von kleinen Werkstücken
For small parts parting off

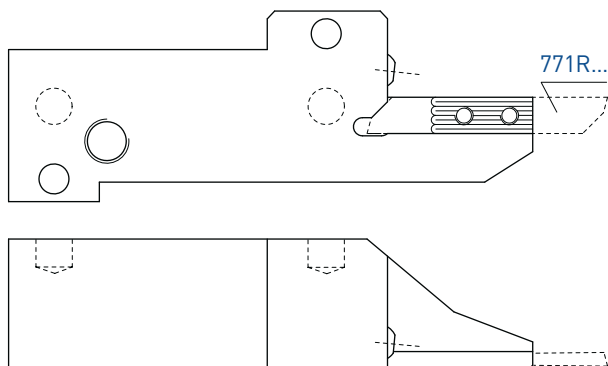

Art. N°	Plaquettes type WSP Typ Inserts type	Pages Seiten Pages
770R-DECO13	771R	1.137 - 1.140

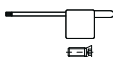
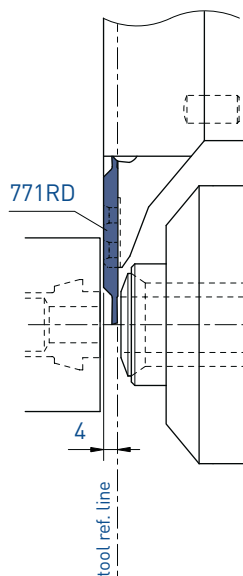
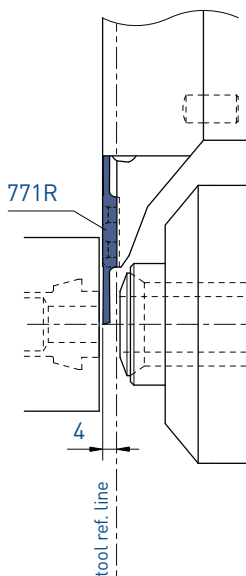

Chaque support est livré avec vis et clé.
Jeder Halter wird mit Spannschraube(n) und Schlüssel geliefert.
Screw(s) and key are included with each tool holder.

Porte-outils pour machine Tornos

Halter für Tornos Maschine

Holder for Tornos machine

DECO 20
EvoDECO 20/32

Pour le tronçonnage de petites pièces
Zum Abstechen von kleinen Werkstücken
For small parts parting off

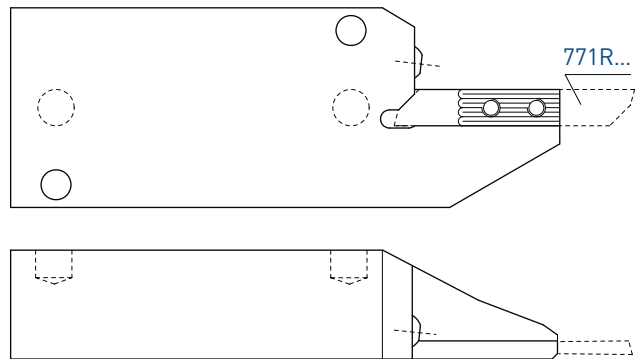

Art. N°	Plaquettes type WSP Typ Inserts type	Pages Seiten Pages
770R-DECO20	771R	1.137 - 1.140

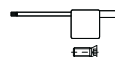
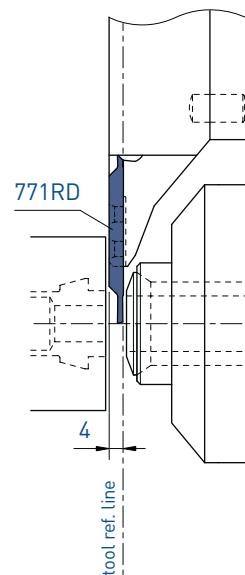
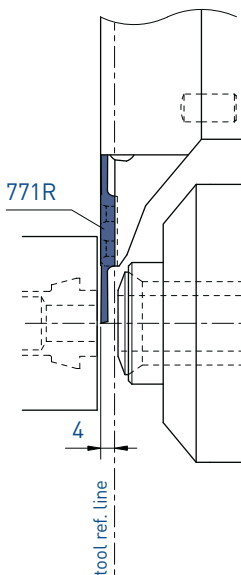

Chaque support est livré avec vis et clé.
Jeder Halter wird mit Spannschraube(n) und Schlüssel geliefert.
Screw(s) and key are included with each tool holder.

Porte-outils pour machine Tornos

Halter für Tornos Maschine

Holders for Tornos machine

MultiSwiss 6x16

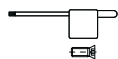
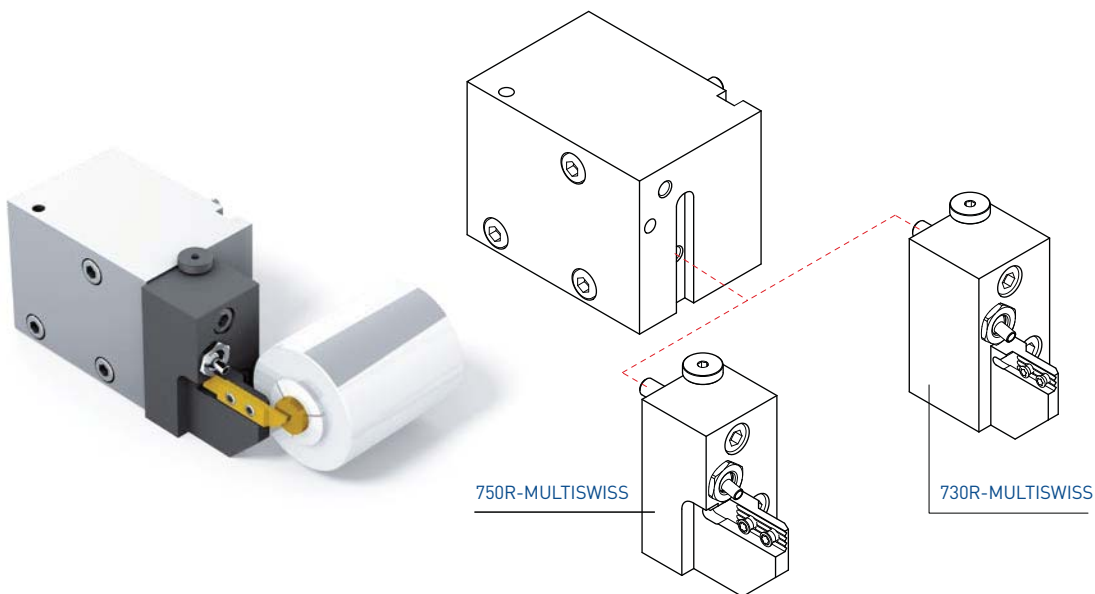

Chaque support est livré avec vis et clé.
 Jeder Halter wird mit Spannschraube(n) und Schlüssel geliefert.
 Screw(s) and key are included with each tool holder.

Art. N°	Plaquettes type WSP Typ Inserts type	Pages Seiten Pages
730R-MULTISWISS	731R / 731N	1.39 - 1.45
750R-MULTISWISS	751R / 751N	1.88 - 1.99

Porte-outils

Halter

Holder

Tornos AS 14
SAS 16

R

750RAS

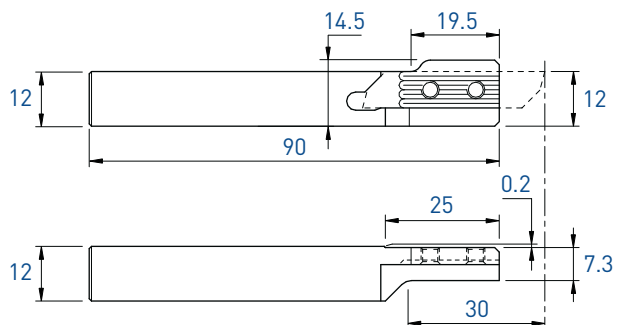

Art. N°	Plaquettes type WSP Typ Inserts type	Pages Seiten Pages
750RAS-12	751R	1.88 - 1.96

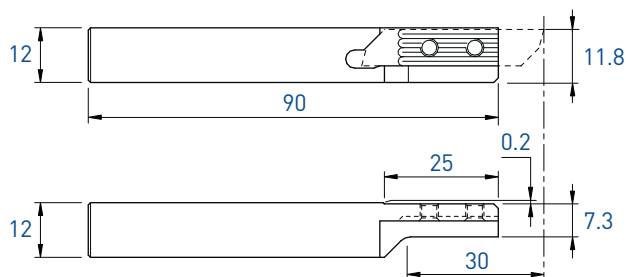

Art. N°	Plaquettes type WSP Typ Inserts type	Pages Seiten Pages
750RAS-12-H11.8	751R	1.88 - 1.96

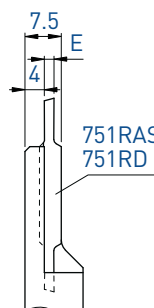
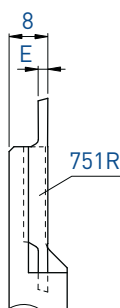
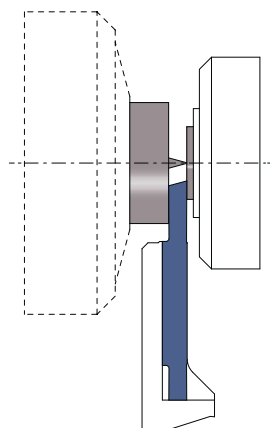

(p. 1.98 - 1.99)



Chaque support est livré avec vis et clé.
Jeder Halter wird mit Spannschraube(n) und Schlüssel geliefert.
Screw(s) and key are included with each tool holder.

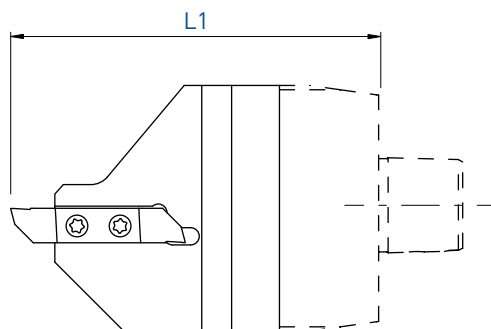

Compatibility Schütte

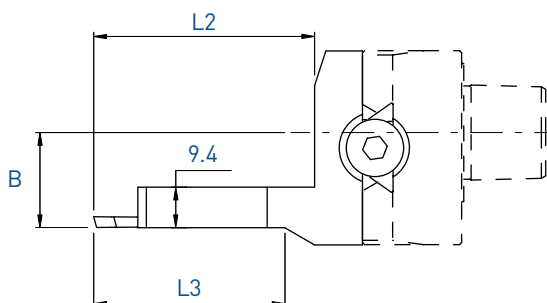
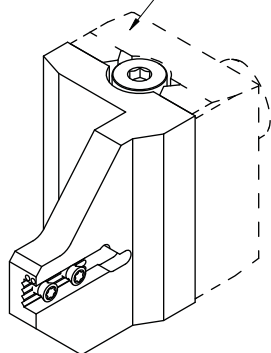

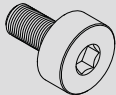

Plaquettes type WSP Typ Inserts type	Pages Seiten Pages	L1	B	L2	L3	Art. N°	Compatibility Schütte	
								Art. N°
761-767	> 1.78	86	22	51	44	DT20-760-JET	C3-75870949	V-M6X0.5-Ø14-L18
		83	27.5	48	-	DT30-760-JET	C4-75836783	

Vis et clés de rechange

Ersatzschrauben und Schlüssel

Spare screws and keys

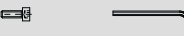
	Porte-outils Halter Holders	Serrage standard (A) Standard Spannsystem (A) Standard clamping system (A) 	Serrage type B Spannsystem Typ B Clamping system type B 			
710	710-6 / - NOVIBRA	V-M2.5X5.8-T8	C-T8	-	-	
	710-7 / - NOVIBRA	V-M2.5X6.5-T8				
	710-8 / - NOVIBRA	V-M2.5X7.8-T8				
	710-10 - 710-12					
720	720-7	V-M2.5X6.5-T8	C-T8	-	-	
	720-8 - 720-12	V-M2.5X7.8-T8				
730	730-7 / - JET / -NOVIBRA	V-M3X7-T8	C-T8	-	-	
	730-8 / -NOVIBRA			V-M2.5X7.8-T8	C-T8	
	730-10 - 730-20					
	730-DECO10					
	730R-DECO10			V-M3X5.5-T8		
740	740-7 / -JET / -NOVIBRA	V-M3X7-T8	C-T8	-	-	
	740-8 / -NOVIBRA - 740-12 / -NOVIBRA			V-M2.5X7.8-T8	C-T8	
	740-16 - 740-20					
	740/730-D					
	740-C			V-M3X5.5-T8		
	740-DECO10			V-M3X7-T8		
	740L-DECO10			V-M3X9-T8		
740-Z						
	Porte-outils Halter Holders	Serrage standard (A) Standard Spannsystem (A) Standard clamping system (A) 	Serrage type B Spannsystem Typ B Clamping system type B 			
750	750-10 - 750-12 / -JET	V-M4X9-T15	C-T15	-	-	
	750-10-AB			V-M3X10-BN21	C-6P-2.0	
	750-12-AB			V-M3X8-BN11		
	750-12.7 - 750-14			V-M3X10-BN11	C-6P-2.5	
	750-16			V-M3X12-BN11		
	750-20			V-M3X16-BN11		
	750RAS - 750-RC			V-M4X7.3-T15		
750R-DECO10	V-M4X5.6-T15					
760	760-10 - 760-12 / -JET / -NOVIBRA / 760/750	V-M4X9-T15	C-T15	-	-	
	760-10-AB			V-M3X10-BN21	C-6P-2.0	
	760-12-AB			V-M3X8-BN11		
	760-12.7 - 760-14			V-M3X10-BN11	C-6P-2.5	
	760-16			V-M3X12-BN11		
	760-20			V-M3X16-BN11		
	760LC			V-M4X7.3-T15		
	760L-DECO10			V-M4X5.6-T15		
	760-Z			V-M4X12-T15		

Vis et clés de recharge

Ersatzschrauben und Schlüssel

Spare screws and keys

	Porte-outils Halter Holders	Serrage standard (A) Standard Spannsystem (A) Standard clamping system (A)		Serrage type B Spannsystem Typ B Clamping system type B	
					
770	770 / -JET 770R	V-M4X9-T15 V-M4X7.3-T15	C-T15	-	-
780	780 / -JET	V-M4X9-T15	C-T15	-	-
7050	7050	V-M4X9-T15	C-T15	-	-
7060	7060	V-M4X9-T15	C-T15	-	-
W	W750 / W760 / -JET	V-M4X11.5-T15	C-T15	-	-
C3	C3-740 C3-760	V-M3X7-T8 V-M4X9-T15	C-T8 C-T15	-	-
C4	C4-750 C4-760	V-M4X9-T15	C-T15	-	-
HSK	HSK-T40-740 HSK-T40-760	V-M3X7-T8 V-M4X9-T15	C-T8 C-T15	-	-
MultiSwiss	730R-MULTISWISS 750R-MULTISWISS	V-M3X5.5-T8 V-M4X7.3-T15	C-T8 C-T15	-	-
Schütte	DT20-760-JET DT30-760-JET	V-M4X9-T15	C-T15	-	-

JET-LINE



NEW



DISCOVER JET-LINE IN A BRAND NEW BROCHURE !

Nouveautés présentées dans ce catalogue
Neuheiten dieses Kataloges
New products introduced in this catalogue



APPLITEC

		page
711-ESF	711-ESF-XN / XTC / XTAF	2.09
742SF	742SF-15/0-2°-30°-HTAF-RE	2.13
	742SF-15/0-2°-30°-XTAF-RE	2.13
743SF (ébauche) (Schruppen) (roughing)	743SF-120/0-12°-HN / HTAF / HTC	2.14
	743SF-140/0-12°-HN / HTAF / HTC	2.14
	743SF-160/0-12°-HN / HTAF / HTC	2.14
	743SF-180/0-12°-HN / HTAF / HTC	2.14
743SF (finition) (Schlichten) (finishing)	743SF-5/5-30°-0.8-HTAF-RE	2.14
	743SF-5/5-30°-1.0-HTAF-RE	2.14
	743SF-8/0-2°-30°-1.0-HTAF-RE / XTAF-RE	2.15
	743SF-15/0-2°-30°-1.2-HTAF-RE / XTAF-RE	2.15
736SFX3	736SFX3-A60-S0.50-AR-HN / HTAF	2.16
	736SFX3-A60-S0.60-AR-HN / HTAF	2.16
	736SFX3-A60-S0.70-AR-HN / HTAF	2.16
	736SFX3-A60-S0.80-AR-HN / HTAF	2.16
	736SFX3-A60-S0.90-AR-HN / HTAF	2.16
	736SFX3-A60-S1.00-AR-HN / HTAF	2.16
748SF	748SF-E03-A45°-L20-HTAF-RE	2.17
749SF	749SF-E03-A45°-L20-B100-HTAF-RE	2.17
731-ESF	731-ESF-HTC / HTAF / HTAXF / HTiN / HN / XTC / XTAF / XN	2.18
741-ESF	741-ESF-HTC / XTC	2.18
731RDSF 751RDSF	731RDSF-0.8-25°-HN / HTAF	2.20
	751RDSF-0.8-25°-HN / HTAF	2.20

Nuances micro-grain à dureté élevée

Verschleissfeste Feinkornsorten

Wear resistant micro-grain grades

> **2.02**

Pièces de rechange

Ersatzteile

Spare parts

> **2.05**pour machines à cames
für kurvengesteuerte Maschinen
for cam driven machines

L

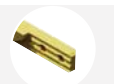
**710**
710SF
710-NOVIBRA > **2.06****711SF** > **2.08****712SF** > **2.08****713SF** > **2.09****711-ESF** > **2.09**pour machines CNC
für CNC-Maschinen
for CNC driven machines

L

R

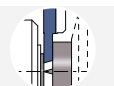
730
730-NOVIBRA > **2.10**
740
740SF
740-NOVIBRA**741SF** > **2.12****742SF** > **2.12****743SF** > **2.14****736SF** > **2.16**
746SF**748SF** > **2.17****749SF** > **2.17****731-ESF** > **2.18**
741-ESF*Coupe à droite déportée / Versetztes Rechtsschneiden / Right cut off line***730RC**
750RC > **2.19**

Porte-outils pour Swissnano - MODU-Line

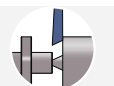
ML12 > **2.19****731R**
751R > **2.20**

Nuances micro-grain à dureté élevée

Verschleissfeste Feinkornsorten

Wear resistant micro-grain grades

HN (μ K10)

non revêtu
unbeschichtet
uncoated

- nuance micro-grain, bonne résistance à l'usure, recommandée pour des opérations d'ébauche et de finition pour des matières ou usinages ne nécessitant aucun revêtement
- verschleissfeste Feinkornsorte, für Schruppen und Schlichtbearbeitung empfohlen oder für Werkstoffe oder Bearbeitungen, die keine Beschichtung erfordern
- wear resistant micro-grain carbide, recommended for roughing and finishing and for materials or operations that do not necessitate any tool coating



HTC

μ K10 + revêtement PVD
 μ K10 + PVD Beschichtung
 μ K10 + PVD coating

- nuance résistante à l'usure, faible coefficient de frottement, recommandée pour des opérations d'ébauche et de finition
- verschleissfeste Sorte, geringer Reibwert, für Schruppen und Schlichtbearbeitung empfohlen
- wear resistant grade, low friction ratio, recommended for roughing and finishing



*conseillée pour l'usinage de la matière 20AP
für Bearbeitung von 20AP geeignet
suitable for machining of 20AP material*

HTC-RE

μ K10 + revêtement PVD
 μ K10 + PVD Beschichtung
 μ K10 + PVD coating

- nuance identique à HTC avec dépouilles rectifiées après revêtement pour des opérations de finition
- gleiche Sorte wie HTC nach der Beschichtung geschliffener Freiwinkel, für Schlichtbearbeitung empfohlen
- same grade as HTC, after coating grounded clearance, recommended for finishing



*conseillée pour l'usinage de la matière 20AP
für Bearbeitung von 20AP geeignet
suitable for machining of 20AP material*

HTAF

μ K10 + revêtement PVD
 μ K10 + PVD Beschichtung
 μ K10 + PVD coating

- nuance résistante à l'usure, recommandée pour des opérations d'ébauche et de finition
- verschleissfeste Sorte, für Schruppen und Schlichtbearbeitung empfohlen
- wear resistant grade, recommended for roughing and finishing



*conseillée pour l'usinage des matières Finemac et inox 4c27a
für Bearbeitung von Finemac und 4c27a-Rostfreier Stahl geeignet
suitable for machining of Finemac and 4c27a stainless steel*

Nuances micro-grain à dureté élevée

Verschleissfeste Feinkornsorten

Wear resistant micro-grain grades

HTAF-RE

μK10 + revêtement PVD
μK10 + PVD Beschichtung
μK10 + PVD coating

- nuance identique à HTAF avec dépouilles rectifiées après revêtement pour des opérations de finition
- gleiche Sorte wie HTAF nach der Beschichtung geschliffener Freiwinkel, für Schlichtbearbeitung empfohlen
- same grade as HTC, after coating grounded clearance, recommended for finishing



recommandée pour les matières Finemac et inox 4c27a
für Bearbeitung von Finemac und 4c27a-Rostfreier Stahl geeignet
suitable for machining of Finemac and 4c27a stainless steel

HTAXF

μK10 + revêtement PVD
μK10 + PVD Beschichtung
μK10 + PVD coating

- nuance complémentaire, résistante à l'usure et à la température pour l'usinage ébauche et finition des matières inox 304, 316L, 317L, 904, Phynox Aciers alliés contenant: Chrome Nickel, Vanadium, molybdène...
- komplementäre Sorte, verschleissfest und temperaturbeständig. Für Schruppen und Schlichtbearbeitung von Materialien Innox 304, 316L, 317L, 904, Phynox Legierter Stahl enthaltend Chrom-Nickel, Vanadium, Molybdän...
- complementary grade, wear and temperature resistant for roughing and finishing of following materials: Innox 304, 316L, 317L, 904, Phynox Alloy steel containing Chrome-nickel, Vanadium, Molybdenum...



HTAXF-RE

μK10 + revêtement PVD
μK10 + PVD Beschichtung
μK10 + PVD coating

- nuance identique à HTAXF avec dépouilles rectifiées après revêtement pour des opérations de finition
- gleiche Sorte wie HTAXF nach der Beschichtung geschliffener Freiwinkel, für Schlichtbearbeitung empfohlen
- same grade as HTAXF, after coating grounded clearance, recommended for finishing

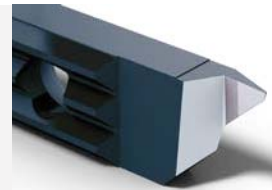

HTiN

μK10 + revêtement PVD
μK10 + PVD Beschichtung
μK10 + PVD coating

- nuance résistante à l'usure, faible coefficient de frottement, recommandée pour des opérations d'ébauche et de finition
- verschleissfeste Sorte, geringer Reibwert, für Schruppen und Schlichtbearbeitung empfohlen
- wear resistant grade, low friction ratio, recommended for roughing and finishing



Nuances micro-grain à dureté élevée
Verschleissfeste Feinkornsorten
Wear resistant micro-grain grades

XN (μ K01)

non revêtu
 unbeschichtet
 uncoated

- nuance micro-grain très résistante à l'usure, recommandée pour des opérations d'ébauche et de finition pour des matières ou usinages nécessitant aucun revêtement
- sehr verschleissfeste Sorte, für Schruppen und Schlichtbearbeitung empfohlen oder für Werkstoffe oder Bearbeitungen, die keine Beschichtung erfordern
- wear resistant micro-grain carbide, recommended for roughing and finishing and for materials or operations that do not necessitate any tool coating



XTC

μ K01 + revêtement PVD
 μ K01 + PVD Beschichtung
 μ K01 + PVD coating

- nuance très résistante à l'usure, faible coefficient de frottement, recommandée pour des opérations de finition
- sehr verschleissfeste Sorte, geringer Reibwert, für Schlichtbearbeitung empfohlen
- very wear resistant grade, low friction ratio, recommended for finishing



XTAF

μ K01 + revêtement PVD
 μ K01 + PVD Beschichtung
 μ K01 + PVD coating

- nuance très résistante à l'usure, recommandée pour des opérations de finition, conseillée pour l'usinage des matières très abrasives
- sehr verschleissfeste Sorte, für Schlichtbearbeitung empfohlen, für die Bearbeitung von sehr abrasive Rohstoffe geeignet
- very wear resistant grade, recommended for finishing, suitable for machining of very abrasive materials



XTAF-RE

μ K01 + revêtement PVD
 μ K01 + PVD Beschichtung
 μ K01 + PVD coating

- nuance identique à XTAF avec dépouilles rectifiées après revêtement pour des opérations de finition
- gleiche Sorte wie XTAF nach der Beschichtung geschliffener Freiwinkel, für Schlichtbearbeitung empfohlen
- same grade as XTAF, after coating grounded clearance, recommended for finishing



Nuances micro-grain à dureté élevée

Verschleissfeste Feinkornsorten

Wear resistant micro-grain grades

XTAXF

μK01 + revêtement PVD
μK01 + PVD Beschichtung
μK01 + PVD coating

- nuance complémentaire très résistante à l'usure et à la température pour la finition des matières inox 304, 316L, 317L, 904, Phynox
Aciers alliés contenant: Chrome Nickel, Vanadium, Molybdène...
- komplémentere Sorte, sehr verschleissfest und temperaturbeständig. Für Schlichtbearbeitung von Materialien Inox 304, 316L, 317L, 904, Phynox
Legierter Stahl enthaltend Chrom-Nickel, Vanadium, Molybdän...
- complementary grade, very wear and temperature resistant for finishing of following materials: Inox 304, 316L, 317L, 904, Phynox
Alloy steel containing Chrome-nickel, Vanadium, Molybdenum...



XTAXF-RE

μK01 + revêtement PVD
μK01 + PVD Beschichtung
μK01 + PVD coating

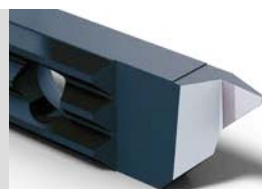

- nuance identique à XTAXF avec dépouilles rectifiées après revêtement pour des opérations de finition
- gleiche Sorte wie XTAXF nach der Beschichtung geschliffener Freiwinkel, für Schlichtbearbeitung empfohlen
- same grade as XTAXF, after coating grounded clearance, recommended for finishing



Pièces de rechange

Ersatzteile

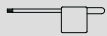
Spare parts

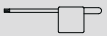
	Porte-outils Halter Holders	Serrage standard (A) Standard Spannsystem (A) Standard clamping system (A)		Serrage type B Spannsystem Typ B Clamping system type B	
					
710	710-6 / - NOVIBRA	V-M2.5X5.8-T8	C-T8	-	-
	710-7 / - NOVIBRA / - SF	V-M2.5X6.5-T8			
	710-8 / - NOVIBRA / -SF	V-M2.5X7.8-T8			
	710-10 - 710-12				
730	730-7 / - NOVIBRA	V-M3X7-T8	C-T8	-	-
	730-8 / - NOVIBRA			V-M2.5X7.8-T8	C-T8
	730-10 - 730-12			-	-
740	740-7 / -NOVIBRA / -SF	V-M3X7-T8	C-T8	-	-
	740-8 / -NOVIBRA / -SF - 740-12 / -NOVIBRA / - SF			V-M2.5X7.8-T8	C-T8

Porte-outils

Halter

Holder

L

710

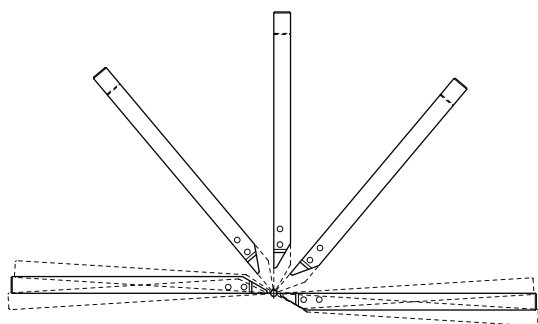

Porte-outils pour machines à cames à gauche
 Halter für linksdrehende kurvgesteuerte Maschinen
 Tool holders for left hand turning cam driven machines

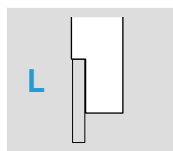
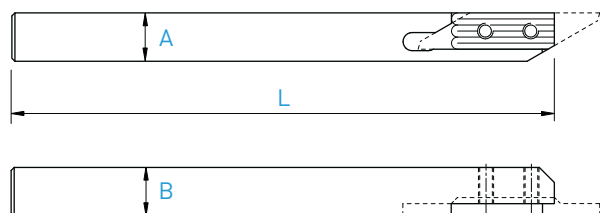

A x B	L	Serrage Spannsystem Clamping	Art. N°
6 x 6	115	A	710-6
7 x 7	115	A	710-7
8 x 8	115	A	710-8
8 x 8	140	A	710-8-140
10 x 10	115	A	710-10
12 x 12	130	A	710-12

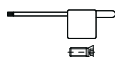

Chaque support est livré avec vis et clé.
 Jeder Halter wird mit Spanschraube(n) und Schlüssel geliefert.
 Screw(s) and key are included with each tool holder.

Porte-outils

Halter

Holders

L

710-SF

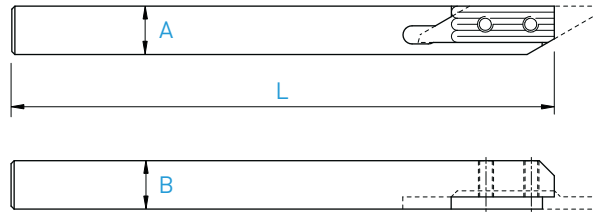

Super finition des 4 faces
4 seitig feinstgeschliffen
4 sides superfinish

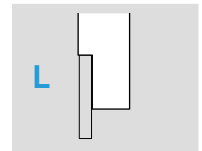

A x B	L	Serrage Spannsystem Clamping	Art. N°
7 x 7	140	A	710-7-140-SF
8 x 8	140	A	710-8-140-SF

Porte-outils en métal lourd anti-vibratoire

Schwingungdämpfender Schwermetallhalter

Low vibration heavy metal holders

L

710-NOVIBRA

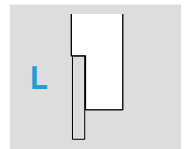

A x B	L	Serrage Spannsystem Clamping	Art. N°
6 x 6	115	A	710-6-NOVIBRA
7 x 7	115	A	710-7-NOVIBRA
8 x 8	115	A	710-8-NOVIBRA

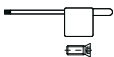

Chaque support est livré avec vis et clé.
Jeder Halter wird mit Spannschraube(n) und Schlüssel geliefert.
Screw(s) and key are included with each tool holder.

TOP-WATCH

Plaquettes d'horlogerie pour machines à cames

Uhrenindustrie-WSP für kurvengesteuerte Maschinen

Watch industry inserts for cam driven machines

L

711SF / 712SF

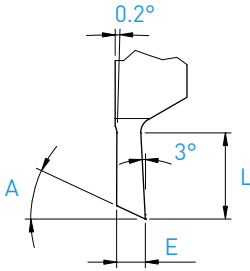
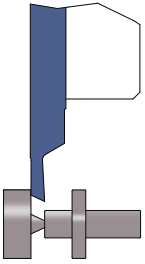

Tronçonnage
Abstechen
Parting off

E	L	A	Art. N°	HTC	HTC-RE	HTAF	HTiN	HN (µK10)
0.8	3.0	25°	711SF-0.8-25°	■	■	■	■	■
1.0	3.0	25°	711SF-1.0-25°	■	□	■	□	■

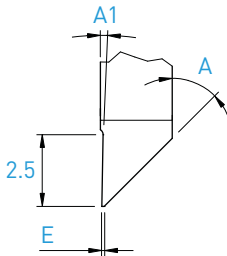
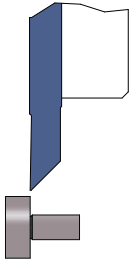

Tournage avant ébauche / finition
Vorwärts drehen schruppen / schlichten
Front turning for roughing / finishing

E	A	A1	Art. N°	HTC	HTC-RE	HTAF	HTiN	HN (µK10)
0.03	45°	3°	712SF-3/3-45°	■	□	■	□	■
0.08	45°	1°	712SF-8/8-45°	■	■	■	□	■

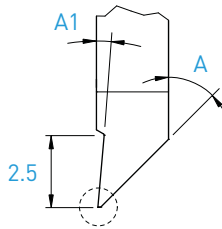
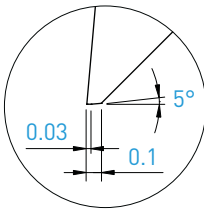
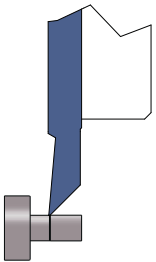

Tournage avant finition (pivotage)
Vorwärts drehen schlichten
Front turning for finishing

A	A1	Art. N°	HTC	HTC-RE	HTAF	HTiN	HN (µK10)
45°	3°	712SF-10/3	■	□	■	■	■

Plaquettes d'horlogerie pour machines à cames

Uhrenindustrie-WSP für kurvengesteuerte Maschinen

Watch industry inserts for cam driven machines

L

713SF

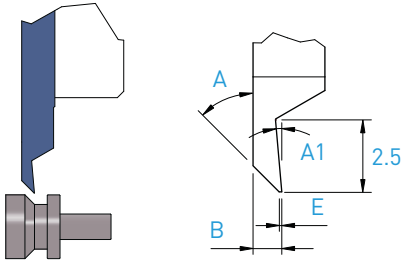

Tournage arrière ébauche / finition
Rückwärts drehen schrappen / schlichten
Back turning for roughing / finishing

E	B	A	A1	Art. N°	HTC	HTC-RE	HTAF	HTiN	HN (µK10)
0.03	1.0	45°	5°	713SF-3/3-45°-1.0	■	□	□	□	■
0.1	1.0	45°	5°	713SF-10/10-45°-1.0	■	□	■	□	■

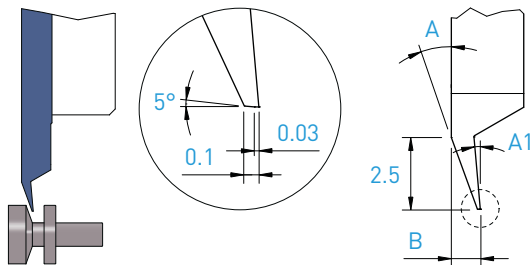

Tournage arrière finition
Rückwärts drehen schlichten
Back turning for finishing

B	A	A1	Art. N°	HTC	HTC-RE	HTAF	HTiN	HN (µK10)
1.0	20°	5°	713SF-10/3	■	□	■	■	■

Plaquettes ébauches

WSP-Rohlinge

Blank inserts

L

711-ESF

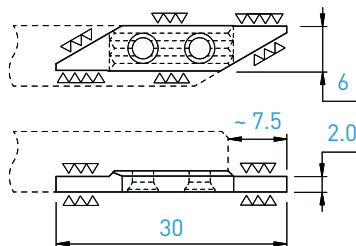

Art. N°	HTC	HTAF	HTiN	HN (µK10)	XN (µK01)	XTC	XTAF
711-ESF	■	■	□	■	■	■	■

Porte-outils

Halter

Holder

L/R

730 / 740

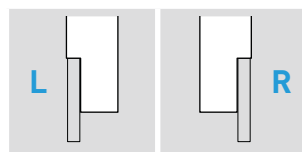
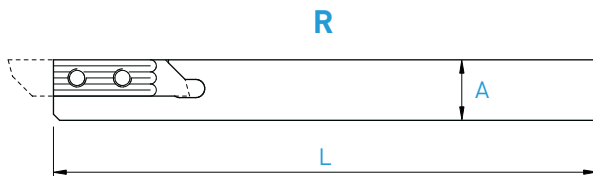
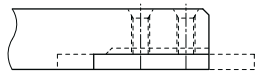
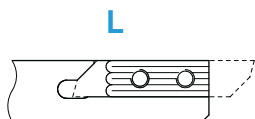

A x B	L	Serrage Spannsystem Clamping	Art. N°	Art. N°
7 x 7	115	A	730-7	740-7
8 x 8	115	A + B	730-8	740-8
8 x 8	140	A + B	730-8-140	-
10 x 10	115	A + B	730-10	740-10
12 x 12	130	A + B	730-12	740-12
12 x 12	90	A + B	730-12-90	740-12-90

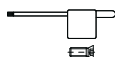

Chaque support est livré avec vis et clé.
Jeder Halter wird mit Spannschraube(n) und Schlüssel geliefert.
Screw(s) and key are included with each tool holder.

Porte-outils

Halter

Holder

R

740-SF

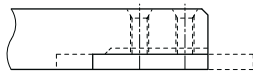
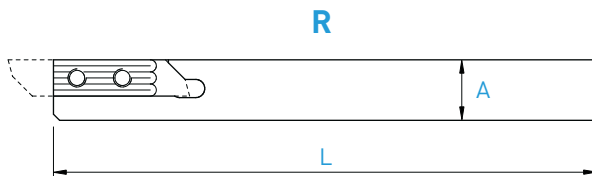
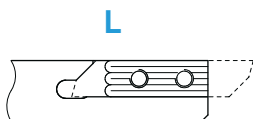

Super finition des 4 faces
4 seitig feinstgeschliffen
4 sides superfinish

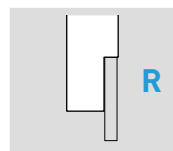

A x B	L	Serrage Spannsystem Clamping	Art. N°
7 x 7	90	A	740-7-90-SF
8 x 8	115	A + B	740-8-SF
8 x 8	90	A + B	740-8-90-SF
10 x 10	115	A + B	740-10-SF
10 x 10	90	A + B	740-10-90-SF
12 x 12	130	A + B	740-12-SF
12 x 12	90	A + B	740-12-90-SF

Porte-outils en métal lourd anti-vibratoire

Schwingungdämpfender Schwermetallhalter

Low vibration heavy metal holders

L/R

730 / 740-NOVIBRA

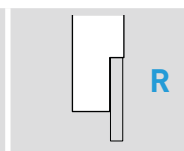
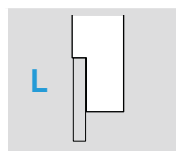

A x B	L	Serrage Spannsystem Clamping	Art. N°	Art. N°
7 x 7	115	A	730-7-NOVIBRA	740-7-NOVIBRA
8 x 8	115	A + B	730-8-NOVIBRA	740-8-NOVIBRA
8 x 8	80	A + B	-	740-8-80-NOVIBRA
10 x 10	115	A + B	-	740-10-NOVIBRA
12 x 12	130	A + B	-	740-12-NOVIBRA

Chaque support est livré avec vis et clé.

Jeder Halter wird mit Spannschraube(n) und Schlüssel geliefert.

Screw(s) and key are included with each tool holder.

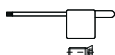

Plaquettes d'horlogerie pour machines CNC
 Uhrenindustrie-WSP für CNC-Maschinen
 Watch industry inserts for CNC machines

R

741SF / 742SF

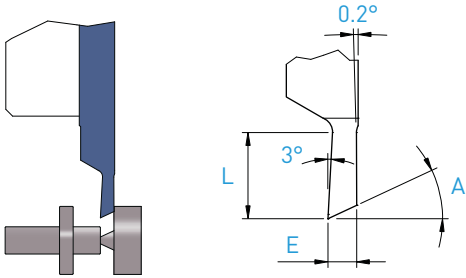

Tronçonnage
 Abstechen
 Parting off

E	L	A	Art. N°	HTC	HTC-RE	HTAF	HTAF-RE	HTAXF	HTAXF-RE	HTIN	HN (µK10)	XTAF	XTAXF	XTAXF-RE	XN (µK01)
0.5	2.0	25°	741SF-0.5-25°	■	□	■	□	■	□	□	■	■	■	□	□
0.8	3.0	25°	741SF-0.8-25°	■	□	■	□	■	□	□	■	■	■	□	□
1.0	3.0	25°	741SF-1.0-25°	■	□	■	□	■	□	□	■	■	■	□	□
1.2	6.0	22°	741SF-1.2-22°	■	□	■	□	■	□	□	■	■	■	□	□

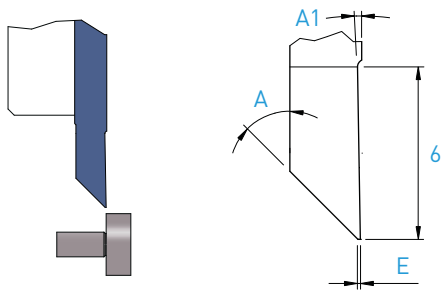

Tournage avant ébauche / finition
 Vorwärts drehen schruppen / schlichten
 Front turning for roughing / finishing

E	A	A1	Art. N°	HTC	HTC-RE	HTAF	HTAF-RE	HTAXF	HTAXF-RE	HTIN	HN (µK10)	XTAF	XTAXF	XTAXF-RE	XN (µK01)
0.03	45°	3°	742SF-3/3-45°	■	■	■	■	■	■	□	■	■	■	□	■
0.08	45°	1°	742SF-8/8-45°	■	■	■	■	■	■	□	■	■	■	□	■

7XX-XX-B



Sur demande pour serrage type B, voir page 2.21
 Wahlweise für B-Spannsystem, siehe Seite 2.21
 On request for B clamping system, see page 2.21

Plaquettes d'horlogerie pour machines CNC

Uhrenindustrie-WSP für CNC-Maschinen

Watch industry inserts for CNC machines

R

742SF

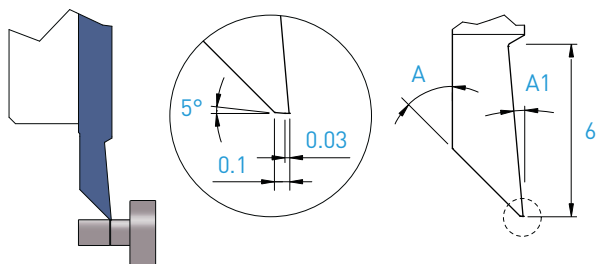

Tournage avant finition
Vorwärts drehen schlichten
Front turning for finishing

A	A1	Art. N°	HTC	HTC-RE	HTAF	HTAF-RE	HTAXF	HTAXF-RE	HTIN	HN (µK10)	XTAF	XTAF-RE	XN (µK01)
45°	5°	742SF-10/3	■	■	■	□	□	□	■	■	■	□	□

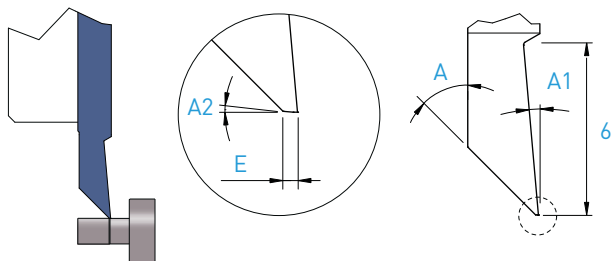

Tournage avant finition
Vorwärts drehen schlichten
Front turning for finishing

E	A	A1	A2	Art. N°	HTAF-RE	XTAF-RE
0.1	45°	5°	5°	742SF-10/0-5°-45°	■	■
0.15	30°	3°	2°	742SF-15/0-2°-30°	■	■

7XX-XX-B



Sur demande pour serrage type B, voir page 2.21
Wahlweise für B-Spannsystem, siehe Seite 2.21
On request for B clamping system, see page 2.21

■ = disponible / verfügbar / available

□ = selon disponibilité du stock / jenach Lagerverfügbarkeit / depending on stock availability

Plaquettes d'horlogerie pour machines CNC
 Uhrenindustrie-WSP für CNC-Maschinen
 Watch industry inserts for CNC machines

R

743SF

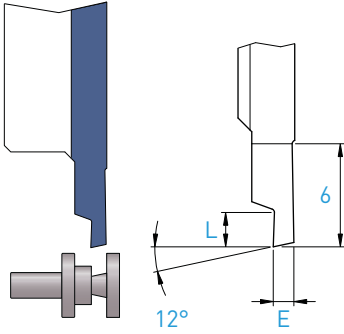

Tournage arrière ébauche
 Rückwärts drehen schrappen
 Back turning for roughing

E	L	Art. N°	HTC	HTAF	HN (µK10)
1.2	2.5	743SF-120/0-12°	■	■	■
1.4	3.0	743SF-140/0-12°	■	■	■
1.6	3.0	743SF-160/0-12°	■	■	■
1.8	4.0	743SF-180/0-12°	■	■	■

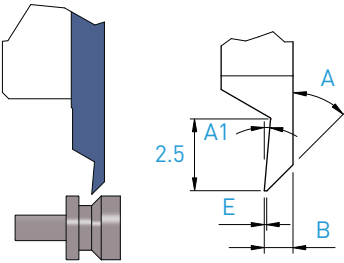

Tournage arrière ébauche/finition
 Rückwärts drehen schrappen/schlichten
 Back turning for roughing/finishing

E	B	A	A1	Art. N°	HTC	HTC-RE	HTAF	HTAF-RE	HTAXF	HTAXF-RE	HTiN	HN (µK10)	XTAF	XTAXF	XTAXF-RE	XN (µK01)
0.03	1.0	45°	5°	743SF-3/3-45°-1.0	■	■	■	■	■	■	□	■	■	■	■	■
0.03	1.2	45°	5°	743SF-3/3-45°-1.2	■	■	■	■	■	■	□	■	■	■	■	■
0.1	1.0	45°	5°	743SF-10/10-45°-1.0	■	■	■	■	■	■	□	■	■	■	■	■
0.05	0.8	30°	3°	743SF-5/5-30°-0.8				■								
0.05	1.0	30°	3°	743SF-5/5-30°-1.0				■								

7XX-XX-B



Sur demande pour serrage type B, voir page 2.21
 Wahlweise für B-Spannsystem, siehe Seite 2.21
 On request for B clamping system, see page 2.21

Plaquettes d'horlogerie pour machines CNC
 Uhrenindustrie-WSP für CNC-Maschinen
 Watch industry inserts for CNC machines

R

743SF

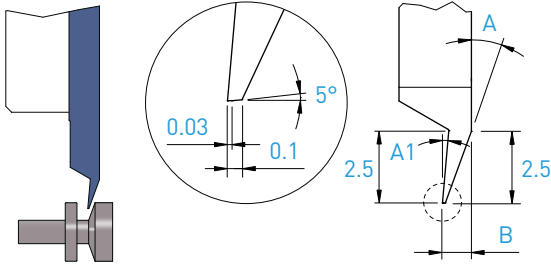

Tournage arrière finition
 Rückwärts drehen schlichten
 Back turning for finishing

B	A	A1	Art. N°	HTC	HTC-RE	HTAF	HTAF-RE	HTAXF	HTAXF-RE	HTIN	HN (µK10)	XTAF	XTAXF	XTAXF-RE	XN (µK01)
1.0	20°	5°	743SF-10/3	■	■	■	■	■	■	□	■	■	■	□	□

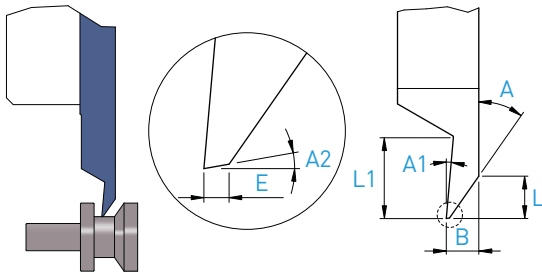

Tournage arrière finition
 Rückwärts drehen schlichten
 Back turning for finishing

E	B	L	L1	A	A1	A2	Art. N°	HTAF-RE	XTAF-RE
0.08	1.0	1.6	2.5	30°	5°	2°	743SF-8/0-2°-30°-1.0	■	■
0.15	1.2	1.8	4.0	30°	3°	2°	743SF-15/0-2°-30°-1.2	■	■
0.1	1.0	1.3	2.5	35°	5°	10°	743SF-10/0-10°-35°-1.0	■	■

7XX-XX-B



Sur demande pour serrage type B, voir page 2.21
 Wahlweise für B-Spannsystem, siehe Seite 2.21
 On request for B clamping system, see page 2.21

■ = disponible / verfügbar / available
 □ = selon disponibilité du stock / jenach Lagerverfügbarkeit / depending on stock availability

Filetage à profil partiel – norme NIHS
Gewinde drehen mit Teilprofil – Norm NIHS
Threading with partial profile – norm NIHS

R/L

746SF / 736SF

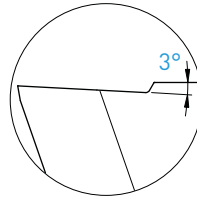
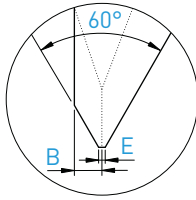
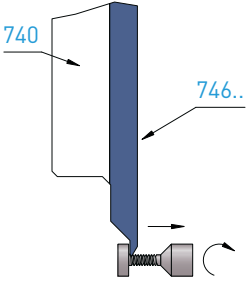

Filetage à droite
sens rotation machine M3

 Rechtgewinde Drehrichtung
der Maschine M3

 Right-hand thread rotating
machinery M3

Filetage Gewinde drehen Threading	Pas Steigung Pitch P	B	E 0/-0.01	Art. N°	HTAF HN (µK10)
S0.50	0.125	0.07	0.015	746SFX3-A60-S0.50-AR	■ ■
S0.60	0.150	0.09	0.020	746SFX3-A60-S0.60-AR	■ ■
S0.70	0.175	0.10	0.020	746SFX3-A60-S0.70-AR	■ ■
S0.80	0.200	0.12	0.025	746SFX3-A60-S0.80-AR	■ ■
S0.90	0.225	0.13	0.030	746SFX3-A60-S0.90-AR	■ ■
S1.00	0.250	0.15	0.035	746SFX3-A60-S1.00-AR	■ ■

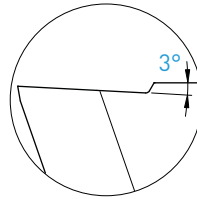
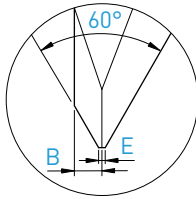
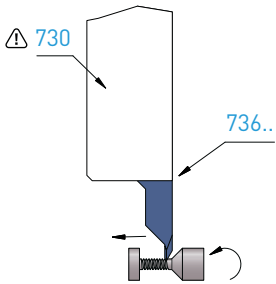

Filetage à droite
sens rotation machine M4

 Rechtgewinde Drehrichtung
der Maschine M4

 Right-hand thread rotating
machinery M4

Filetage Gewinde drehen Threading	Pas Steigung Pitch P	B	E 0/-0.01	Art. N°	HTAF HN (µK10)
S0.50	0.125	0.07	0.015	736SFX3-A60-S0.50-AR	■ ■
S0.60	0.150	0.09	0.020	736SFX3-A60-S0.60-AR	■ ■
S0.70	0.175	0.10	0.020	736SFX3-A60-S0.70-AR	■ ■
S0.80	0.200	0.12	0.025	736SFX3-A60-S0.80-AR	■ ■
S0.90	0.225	0.13	0.030	736SFX3-A60-S0.90-AR	■ ■
S1.00	0.250	0.15	0.035	736SFX3-A60-S1.00-AR	■ ■

7XX-XX-B



Sur demande pour serrage type B, voir page 2.21
 Wahlweise für B-Spannsystem, siehe Seite 2.21
 On request for B clamping system, see page 2.21

Plaquettes piqûre avant

Frontestich WSP

Front grooving inserts

R

748SF

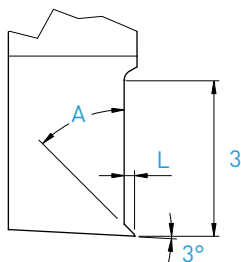
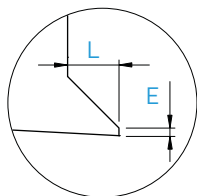
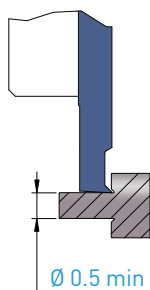

E _{0/-0.01}	A	L	Art. N°	HTC	HTC-RE	HTAF	HTAF-RE	HTIN	HN (µK10)
0.03	45°	0.2	748SF-E03-A45°-L20	■	■	■	■	□	■
0.05	45°	0.3	748SF-E05-A45°-L30	■	■	■		■	■
0.08	45°	0.5	748SF-E08-A45°-L50	■	■	■		□	■

Plaquettes piqûre arrière

Rückestich WSP

Back grooving inserts

R

749SF

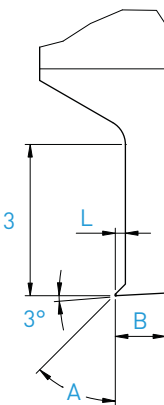
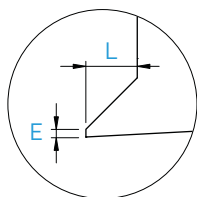
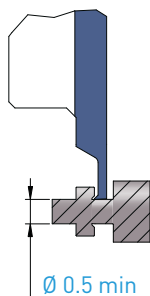

E _{0/-0.01}	A	L	B	Art. N°	HTC	HTC-RE	HTAF	HTAF-RE	HTIN	HN (µK10)
0.03	45°	0.2	1.0	749SF-E03-A45°-L20-B100	■	■	■	■	□	■
0.05	45°	0.3	1.0	749SF-E05-A45°-L30-B100	■	□	■		□	■
0.08	45°	0.5	1.2	749SF-E08-A45°-L50-B120	■	■	■		□	■

7XX-XX-B



Sur demande pour serrage type B, voir page 2.21
Wahlweise für B-Spannsystem, siehe Seite 2.21
On request for B clamping system, see page 2.21

■ = disponible / verfügbar / available
□ = selon disponibilité du stock / jenach Lagerverfügbarkeit / depending on stock availability

Plaquettes ébauches

WSP-Rohlinge

Blank inserts

L/R

731-ESF / 741-ESF

L

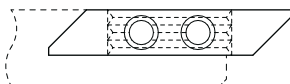

R

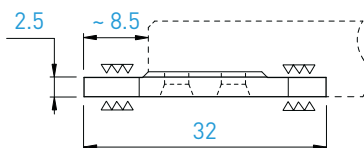
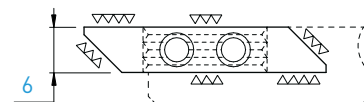

L

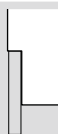

R



L				R													
Art. N°	HTC	HTAF	HTAXF	HTIN	HN (μK10)	XTC	XTAF	XN (μK01)	Art. N°	HTC	HTAF	HTAXF	HTIN	HN (μK10)	XTC	XTAF	XN (μK01)
731-ESF	■	■	■	■	■	■	■	■	741-ESF	■	■	■	■	■	■	■	■

7XX-XX-B



Sur demande pour serrage type B, voir page 2.21
Wahlweise für B-Spannsystem, siehe Seite 2.21
On request for B clamping system, see page 2.21

■ = disponible / verfügbar / available

□ = selon disponibilité du stock / jenach Lagerverfügbarkeit / depending on stock availability

Porte-outils

Halter

Holder

Coupe à droite déportée

Versetztes Rechtsschneiden

Right cut off line

730RC / 750RC

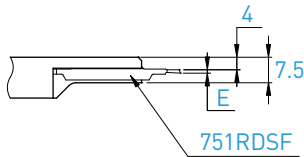
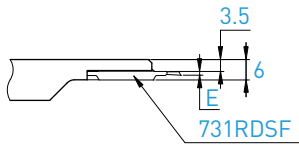
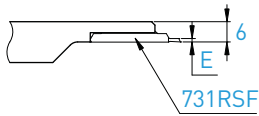
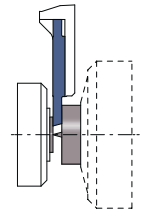
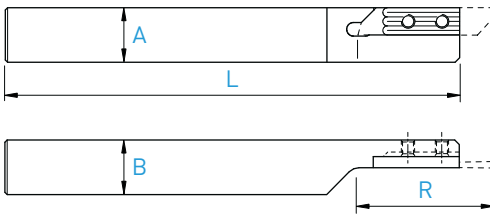

L (R)

Coupe à droite déportée
Versetztes Rechtsschneiden
Right cut off line

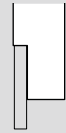

A x B	L	R	Art. N°
8 x 8	115	24	730RC-8
10 x 10	115	24	730RC-10
12 x 12	130	30	730RC-12
16 x 16	130	40	730RC-16

A x B	L	R	Art. N°
12 x 12	130	30	750RC-12
16 x 16	130	40	750RC-16

Porte-outils spéciaux de tronçonnage

Sonder Abstechwerkzeughalter

Special parting off tool holders

MODU-LINE

ML12

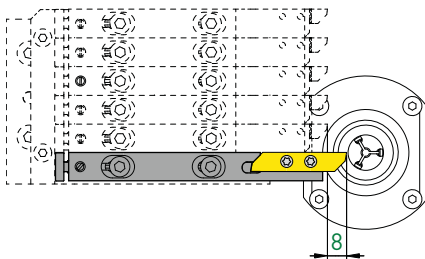

Type de machine Maschinen-Typ Type of machine	Porte-outils Halter Holder	Art. N°	Plaquettes type WSP Typ Inserts type
SwissNano	ML12	ML12A-730RC-SWISS-NANO	731RSF / 731RDSF
SwissNano	ML12	ML12A-750RC-SWISS-NANO	751RDSF

Voir documentation MODU-Line
Siehe MODU-Line Dokumentation
See MODU-Line documentation

Tronçonnage

Abstechen

Parting off

Coupe à droite déportée

Versetztes Rechtsschneiden

Right cut off line

731R / 751R

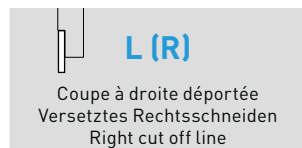
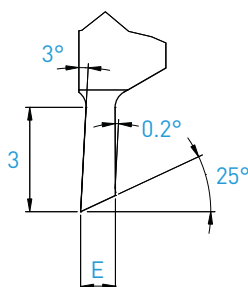
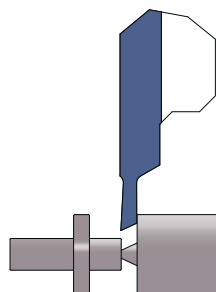

E	Art. N°	HTAF	HTIN	HN (μK10)
1.0	731RSF-1.0-25°	■	■	■

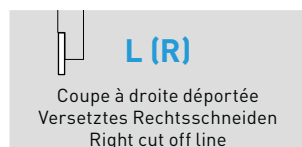
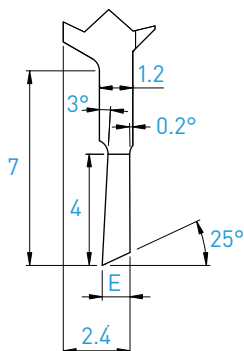
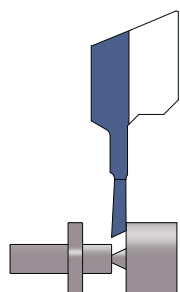

E	Art. N°	HTAF	HTIN	HN (μK10)
0.8	731RDSF-0.8-25°	■	■	■
1.0	731RDSF-1.0-25°	■	□	■

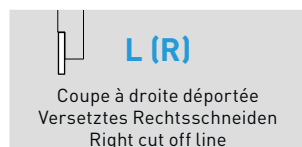
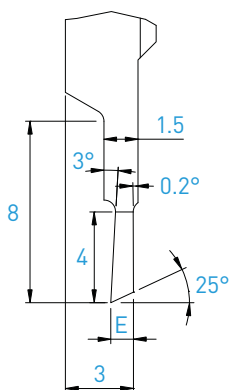
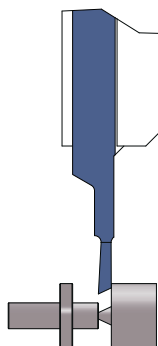

E	Art. N°	HTAF	HTIN	HN (μK10)
0.8	751RDSF-0.8-25°	■	■	■
1.0	751RDSF-1.0-25°	■	□	■

■ = disponible / verfügbar / available

□ = selon disponibilité du stock / jenach Lagerverfügbarkeit / depending on stock availability

L'outil de référence pour le décolletage

Hochwertiges Wendeplattensystem für Langdrehautomaten

Top class turning tool for automatic lathes

700 Series

100% rigid!

Système de serrage Applitec à denture décalée
 Applitec-Spannsystem mit verschobener Verzahnung
 Applitec clamping system with shifted teeth

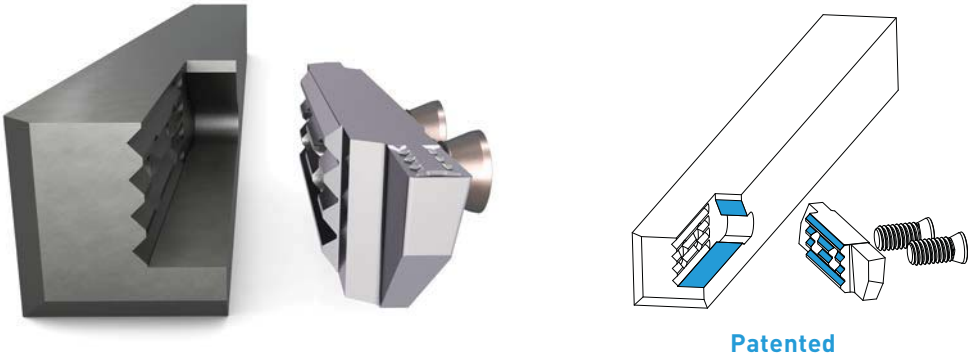

Patented

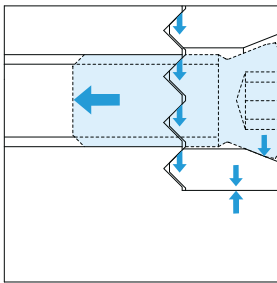

Serrage standard (A)
Standard Spannsystem (A)
Standard clamping system (A)

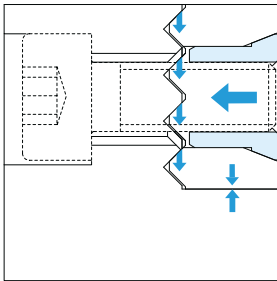
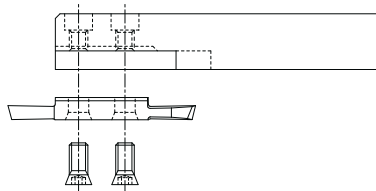

Serrage type B*
Spannsystem Typ B*
Clamping system type B*

ajouter -B après le numéro d'article
 -B nach der Artikelreferenz hinzufügen
 add -B after the article number

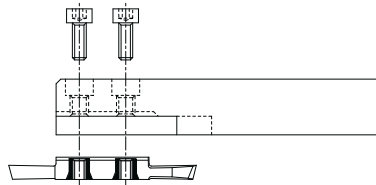

Changement de la plaquette possible dans la machine, sans démontage du porte-outil
 WSP-Austauschmöglichkeit in der Maschine ohne Halterausbau
 The insert can be changed in the machine without removing the tool holder

Nouveautés présentées dans ce catalogue
 Neuheiten dieses Kataloges
 New products introduced in this catalogue



APPLITEC

New carbide HN(μ10)		
Type Typ Type	Ref.	Page Seite Page
631	631-EP	3.30
641	641-EP	3.30
642	642	3.08
	642X	3.09
	642S	3.10
643	643S	3.11
	643	3.12
	643X	3.13
	643XS	3.14
	643VX8	3.15
	643VX15	3.16
	643VUX	3.17

New carbide HN(μ10)		
Type Typ Type	Ref.	Page Seite Page
644	644	3.19
	644X5	3.20
	644X10	3.21
647	647	3.28
651	651-EP	3.44
	651R	3.39
651R	651RXF	3.40
	651RX12	3.41
	661	3.34
661	661XF	3.35
	661X12	3.36
	661-EP	3.44

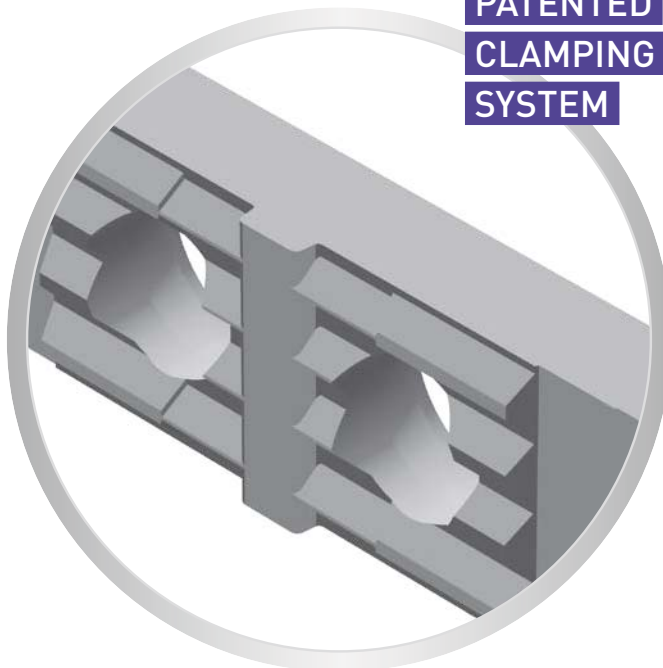

INFO









Codification Bezeichnungsschlüssel Designation key	Paramètres de coupe indicatifs Empfohlene Schnittwerte Standard machining data	Nuances Sorten Grades	> 3.02
--	--	-----------------------------	---------------

**SERIES
630 / 640**

Tournage
et gorge

Drehen und
Einstechen

Turning and
grooving

Porte-outils Halter Holders		630 / 640	> 3.06
Tournage avant Vorwärts drehen Front turning		632 / 642	 > 3.08
Tournage arrière Rückwärts drehen Back turning		633 / 643	 > 3.11
Fonçage-tournage Einstechen und drehen Grooving and turning		634 / 644	 > 3.19
Chanfreinage Anfasen Chamfering		635 / 645	 > 3.24
Filetage Gewinde drehen Threading		636 / 646	 > 3.26
Plaquettes à rayon Radius Wendepplatten Radius inserts		637 / 647	 > 3.28
Plaquettes ébauches WSP-Rohlinge Blank inserts		631-EP / 641-EP	 > 3.30

**SERIES
650 / 660**

Tronçonnage

Abstechen

Parting off

Porte-outils Halter Holders		650 / 660	> 3.31
Tronçonnage Abstechen Parting off		651 / 661	 > 3.34
Tronçonnage - coupe déportée Abstechen - versetztes Schneiden Parting off - cut off line		651R	 > 3.39
Plaquettes ébauches WSP-Rohlinge Blank inserts		651-EP / 661-EP	 > 3.44

Pièces de rechange et accessoires Ersatzteile und Zubehör Spare parts and accessories			> 3.45
---	--	--	---------------

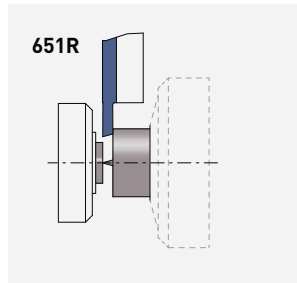
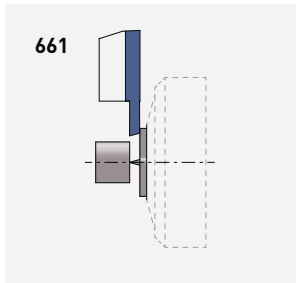
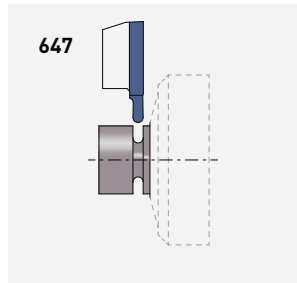
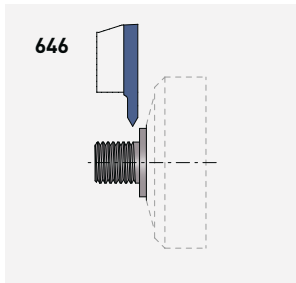
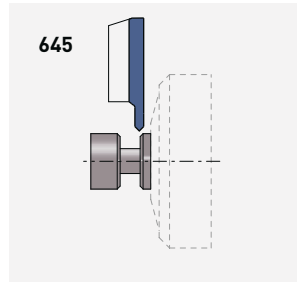
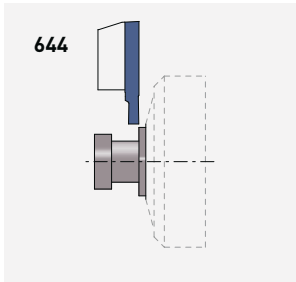
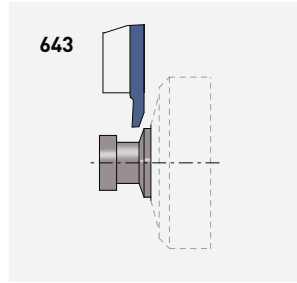
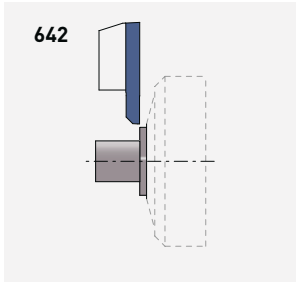

Codification des plaquettes PRO-Line série 600

WSP-Bezeichnungssystem für PRO-Line 600 Serie

Inserts designation key for PRO-Line 600 series

INFO



Dimension
Abmessung
Dimension

Rayon
Radius
Radius

Nuance
Sorte
Grade

Géométrie de coupe
Schneidgeometrie
Cutting geometry

brise-copeau
Spanbrecher
chip breaker

particularités
Sondereigenschaften
special features

Géométrie d'usinage
Bearbeitungsgeometrie
Machining geometry

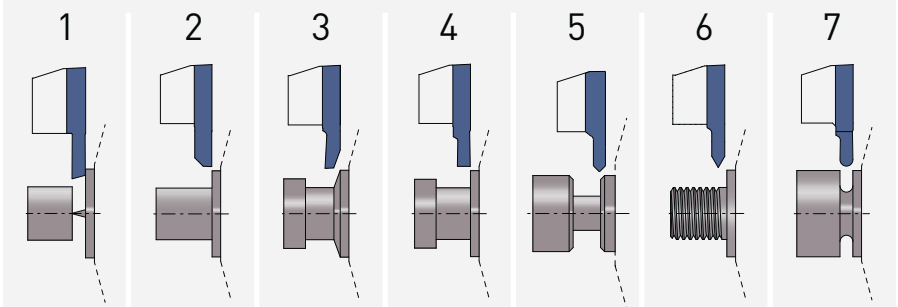

Gamme de produit
Produktserie
Product series

définit la compatibilité des plaquettes avec le porte-outil
bestimmt die WSP und Halter Kompatibilität
shows the inserts and holder compatibility

L = 3, 5

(chiffre impair / ungerade Zahl / uneven number)

R = 4, 6

(chiffre pair / gerade Zahl / even number)

SERIES

Tournage
et gorge

L
630

R
640

Drehen und
Einstechen
Turning and
grooving

W max = 3 mm
L max = 8 mm

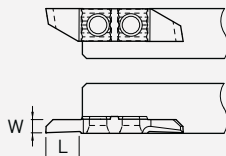

SERIES

Tronçonnage
Abstechen
Parting off

L
650

R
660

W max = 2.5 mm
L max = 11 mm

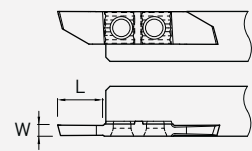

Applitec série 600
Applitec 600 Serie
Applitec 600 series

Système de serrage à denture avec 2 vis de fixation
Spannsystem mit Verzahnung und 2 Schrauben
Teeth clamping system with 2 screws

Paramètres de coupe indicatifs

Empfohlene Schnittwerte

Standard machining data

Matière Werkstoff Material	Tournage Drehen Turning			Tronçonnage Abstechen Parting off		
	VC	630/640		VC	650/660	
		Prof. de passe Schnitttiefe Depth of cut	Avance Vorschub Feed		Largeur de coupe Abstechbreite Cutting width	Avance Vorschub Feed
(m/min)	(mm)	(mm/U)	(m/min)	(mm)	(mm/U)	
Acier de décolletage Automatenstahl Free-cutting steel	P 120 - 200	0.05 - 1.0 1.0 - 4.0	0.01 - 0.15 0.05 - 0.25	80 - 150	0.50 - 1.50 1.50 - 2.50	0.01 - 0.08 0.03 - 0.15
Acier Stahl < 600 N/mm ² Steel	P 80 - 160	0.05 - 1.0 1.0 - 4.0	0.01 - 0.15 0.05 - 0.25	70 - 120	0.50 - 1.50 1.50 - 2.50	0.01 - 0.06 0.03 - 0.12
Acier Stahl < 800 N/mm ² Steel	P 60 - 120	0.05 - 1.0 1.0 - 4.0	0.01 - 0.10 0.05 - 0.20	60 - 100	0.50 - 1.50 1.50 - 2.50	0.01 - 0.05 0.03 - 0.10
Acier Stahl > 800 N/mm ² Steel	P 50 - 100	0.05 - 1.0 1.0 - 3.0	0.01 - 0.08 0.05 - 0.15	40 - 80	0.50 - 1.50 1.50 - 2.50	0.01 - 0.04 0.03 - 0.08
Acier inoxydable Rostfreistahl Stainless steel	M 60 - 120	0.05 - 1.0 1.0 - 3.0	0.01 - 0.08 0.05 - 0.15	60 - 100	0.50 - 1.50 1.50 - 2.50	0.01 - 0.04 0.03 - 0.08
Aluminium Si <12%	N 200 - 1000	0.05 - 1.0 1.0 - 4.0	0.01 - 0.20 0.05 - 0.40	180 - 400	0.50 - 1.50 1.50 - 2.50	0.01 - 0.10 0.03 - 0.20
Aluminium Si >12%	N 180 - 800	0.05 - 1.0 1.0 - 4.0	0.01 - 0.20 0.05 - 0.40	150 - 300	0.50 - 1.50 1.50 - 2.50	0.01 - 0.10 0.03 - 0.20
Cuivre, laiton, bronze Kupfer, Messing, Bronze Copper, brass, bronze	N 100 - 500	0.05 - 1.0 1.0 - 4.0	0.01 - 0.20 0.05 - 0.35	100 - 300	0.50 - 1.50 1.50 - 2.50	0.01 - 0.10 0.03 - 0.20
Titane Titan Titanium	S 30 - 70	0.05 - 1.0 1.0 - 4.0	0.01 - 0.08 0.05 - 0.15	30 - 50	0.50 - 1.50 1.50 - 2.50	0.01 - 0.03 0.03 - 0.06

Nuances

Sorten

Grades

TiAlN

μK20 + revêtement PVD
μK20 + PVD Beschichtung
μK20 + PVD coating

- excellente nuance universelle
- 1^{er} choix pour l'usinage des aciers, aciers inoxydables et alliages de titane
- très bonne résistance à la température

- beste Universalsorte
- für die Bearbeitung von Stahl, rostfreiem Stahl und Titanlegierungen bestens geeignet
- sehr gute Warmfestigkeit

- best universal grade
- first choice for steel, stainless steel and titanium alloys machining
- very good heat resistance

N (μK20)

non revêtu
unbeschichtet
uncoated

- nuance micro-grain tenace
- supporte les coupes interrompues et autres conditions d'usinage défavorables

- zähe Feinkornsorte
- für unterbrochene Schnitte und andere ungünstige Bearbeitungsbedingungen geeignet

- tough micro-grain grade
- suitable for interrupted cut and other unfavourable machining conditions

HTA

μK10 + revêtement PVD
μK10 + PVD Beschichtung
μK10 + PVD coating

- nuance très résistante à l'usure
- pour l'usinage en finition dans des conditions favorables des aciers, aciers inoxydables et alliages de titane

- sehr verschleissfeste Sorte
- für die Feinbearbeitung von Stahl, rostfreiem Stahl und Titanlegierungen bei guten Bearbeitungsbedingungen

- very wear resistant grade
- for light machining of steel, stainless steel and titanium alloys under favourable machining conditions

HN (μK10)

non revêtu
unbeschichtet
uncoated

- nuance micro-grain très résistante à l'usure
- recommandé pour l'usinage du titane faiblement allié
- déconseillé en cas de coupe interrompue et autres conditions d'usinage défavorables

- verschleissfeste Feinkornsorte
- für die Bearbeitung von niedrig legiertem Titan empfehlenswert
- für unterbrochene Schnitte und andere ungünstige Bearbeitungsbedingungen nicht geeignet

- wear resistant micro-grain grade
- suitable for the machining of low alloyed titanium
- not suitable for interrupted cut and other unfavourable machining conditions

L

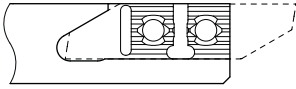

R

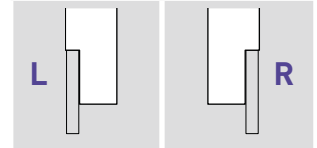
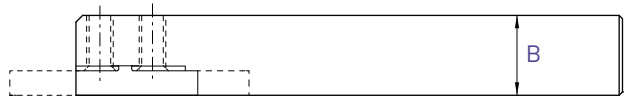
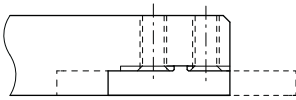

A x B	L	Art. N°	Art. N°
8 x 8	115	630-8	640-8
10 x 10	115	630-10	640-10
10 x 10	50	630-10-50	640-10-50
12 x 12	130	630-12	640-12
12 x 12	90	630-12-90	640-12-90
12.7 x 12.7	130	630-12.7	640-12.7
16 x 16	130	630-16	640-16
16 x 16	75	630-16-75	640-16-75
20 x 20	120	630-20	640-20

Chaque support est livré avec vis et clé.
 Jeder Halter wird mit Spannschraube(n) und Schlüssel geliefert.
 Screw(s) and key are included with each tool holder.

Porte-outils avec arrosage intégré
 Halter mit integrierter Kühlmittelzufuhr
 Holders with integrated coolant supply

630-JET / 640-JET

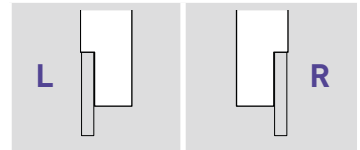
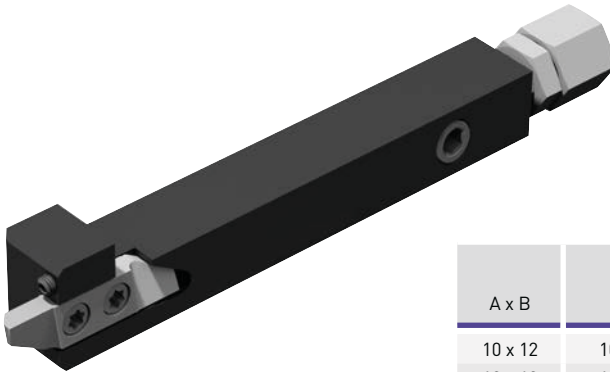
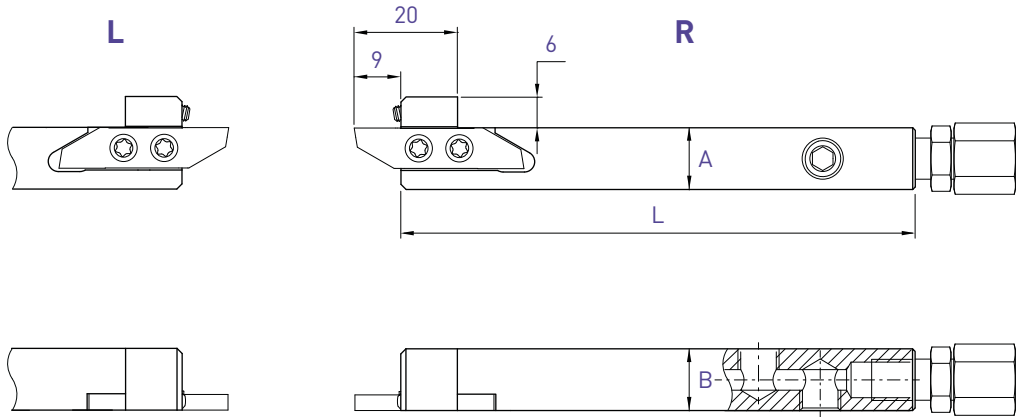

A x B	L	Art. N°	Art. N°
10 x 12	100	630-1012-JET	640-1012-JET
12 x 12	100	630-12-JET	640-12-JET
12.7 x 12.7	100	630-12.7-JET	640-12.7-JET
16 x 16	100	630-16-JET	640-16-JET
20 x 20	100	630-20-JET	640-20-JET

Chaque support est livré avec vis, clé, raccord droit et buse d'arrosage Ø 1.5 mm.
 Jeder Halter wird mit Spannschraube(n), Schlüssel, gerader Kühlmittelanschluss und Kühlmitteldüse Ø 1.5 mm geliefert.
 Screw(s), key, straight connector and coolant nozzle Ø 1.5 mm are included with each tool holder.

PRO-LINE

Tournage avant
Vorwärts drehen
Front turning

632 / 642

L

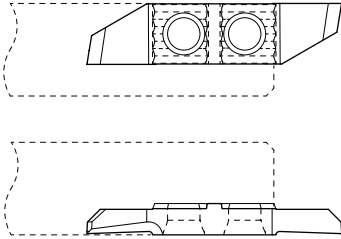

R

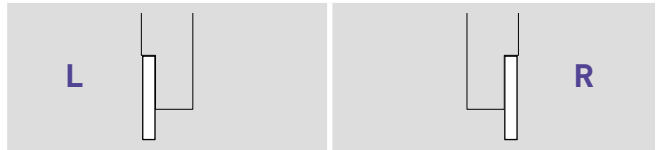
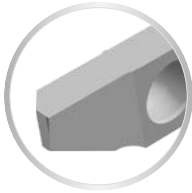
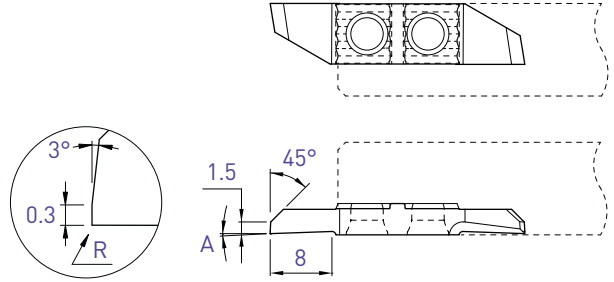

A	R	Art. N°	TiAlN N [µk20]	HTA HN [µk10]	Art. N°	TiAlN N [µk20]	HTA HN [µk10]
0°	0	632	■ ■		642	■ ■	□ □
0°	0.08	-			642-R08	■ ■	□ □
0°	0.15	-			642-R15	■ ■	□ □
2°	0	632-2°	■ ■		642-2°	■ ■	□ □
2°	0.08	-			642-2°-R08	■ ■	□ □
2°	0.15	-			642-2°-R15	■ ■	□ □

Tournage avant
Vorwärts drehen
Front turning

632X / 642X

L

R

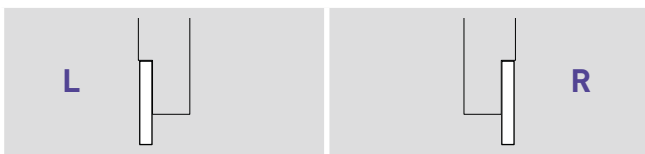
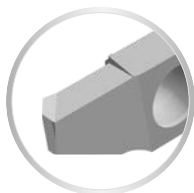
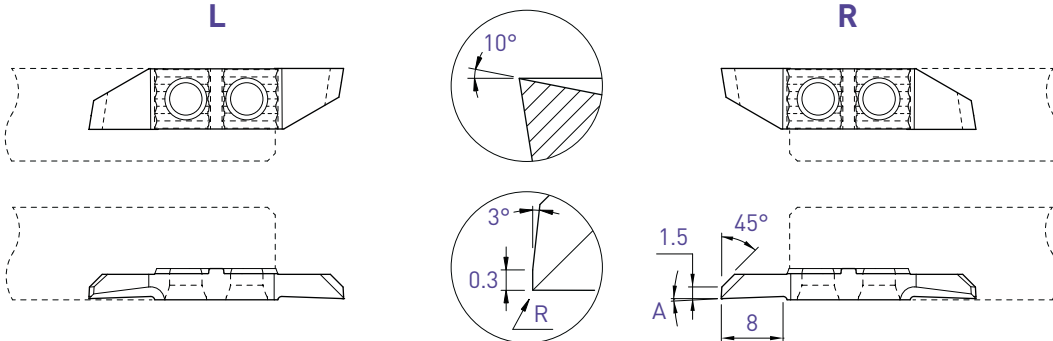

A	R	Art. N°	TiAlN N [µk20]	HTA HN [µk10]	Art. N°	TiAlN N [µk20]	HTA HN [µk10]
0°	0	632X10	■ ■		642X10	■ ■	□ □
0°	0.08	-			642X10-R08	■ ■	□ □
0°	0.15	-			642X10-R15	■ ■	□ □
2°	0	632X10-2°	■ ■		642X10-2°	■ ■	□ □
2°	0.08	-			642X10-2°-R08	■ ■	□ □
2°	0.15	-			642X10-2°-R15	■ ■	□ □

L

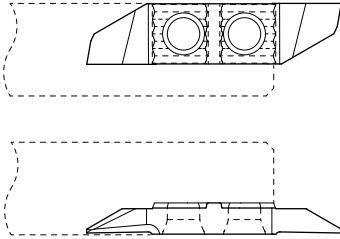

R

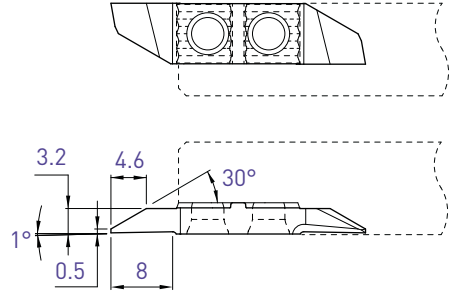

Tournage avant
 Vorwärts drehen
 Front turning

L				R			
Art. N°	TiAlN N (µk20)	HTA	HN (µk10)	Art. N°	TiAlN N (µk20)	HTA	HN (µk10)
632S05	■ ■			642S05	■ ■	□ □	

Tournage multifonction

Mehrweck drehen

Multifunction turning

633S / 643S

L

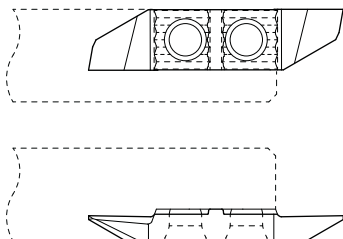

R

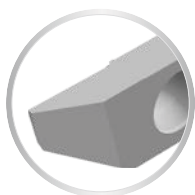
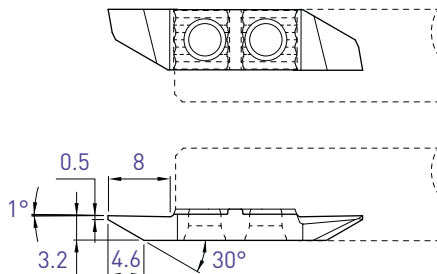

Tournage arrière
Rückwärts drehen
Back turning

L				R			
Art. N°	T/AIN N (µk20)	HTA	HN (µk10)	Art. N°	T/AIN N (µk20)	HTA	HN (µk10)
633S05	■ ■			643S05	■ ■	□ □	

Tournage arrière
 Rückwärts drehen
 Back turning

633 / 643

L

R

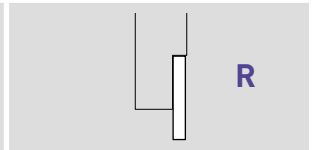
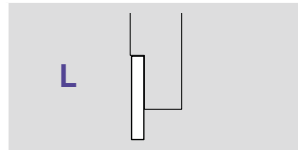
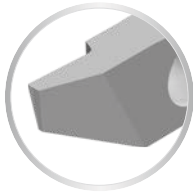
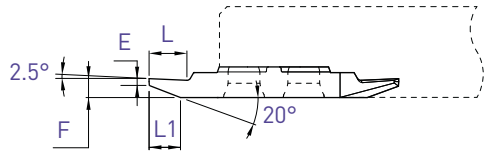
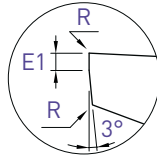
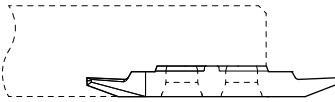
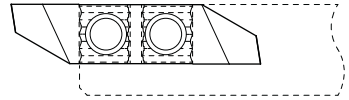
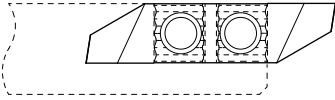

E	E1	L	L1	F	R	Art. N°	TiAlN N (µk20)	HTA HN (µk10)	Art. N°	TiAlN N (µk20)	HTA HN (µk10)
0.5	0.25	3	2.8	1.5	0	633-0.5	■ ■		643-0.5	■ ■	□ □
0.5	0.25	3	2.8	1.5	0.08	-			643-0.5-R08	■ ■	□ □
0.8	0.40	4.5	3.3	2.0	0	-			643-0.8	■ ■	□ □
0.8	0.40	4.5	3.3	2.0	0.08	-			643-0.8-R08	■ ■	□ □
1.0	0.40	5	4.2	2.5	0	-			643-1.0	■ ■	□ □
1.0	0.40	5	4.2	2.5	0.08	-			643-1.0-R08	■ ■	□ □
1.5	0.50	6	4.2	3.0	0	-			643-1.5	■ ■	□ □
1.5	0.50	6	4.2	3.0	0.08	-			643-1.5-R08	■ ■	□ □

Tournage arrière
 Rückwärts drehen
 Back turning

633X / 643X

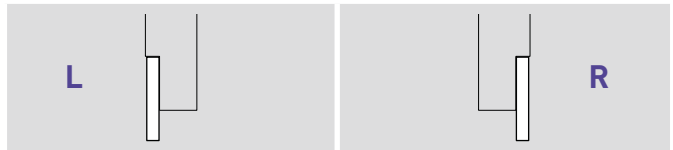
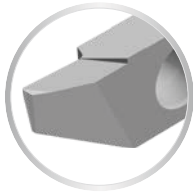
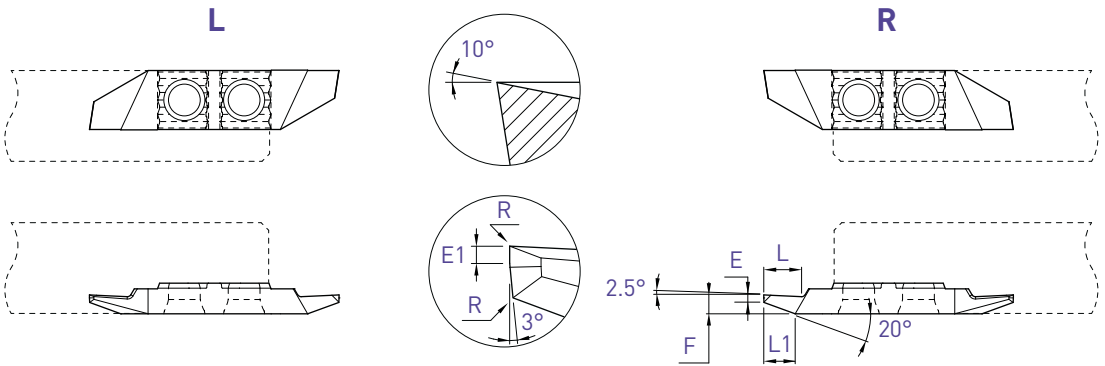

E	E1	L	L1	F	R	Art. N°	TiAlN N (µk20)	HTA HN (µk10)	Art. N°	TiAlN N (µk20)	HTA HN (µk10)
0.5	0.25	3	2.8	1.5	0	633X10-0.5	■ ■		643X10-0.5	■ ■	□ □
0.5	0.25	3	2.8	1.5	0.08	-			643X10-0.5-R08	■ ■	□ □
0.8	0.40	4.5	3.3	2.0	0	-			643X10-0.8	■ ■	□ □
0.8	0.40	4.5	3.3	2.0	0.08	-			643X10-0.8-R08	■ ■	□ □
1.0	0.40	5	4.2	2.5	0	-			643X10-1.0	■ ■	□ □
1.0	0.40	5	4.2	2.5	0.08	-			643X10-1.0-R08	■ ■	□ □
1.5	0.50	6	4.2	3.0	0	-			643X10-1.5	■ ■	□ □
1.5	0.50	6	4.2	3.0	0.08	-			643X10-1.5-R08	■ ■	□ □

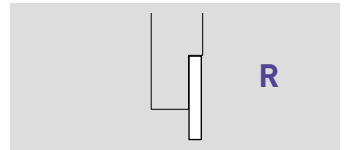
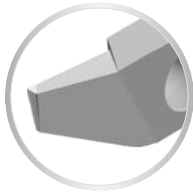
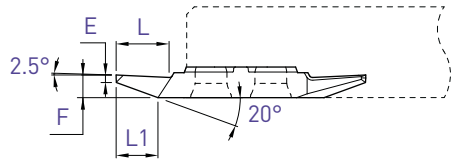
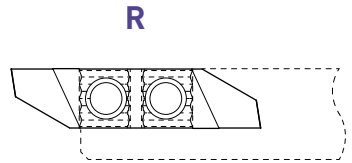
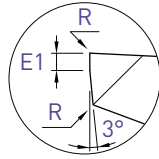
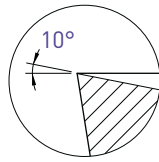

E	E1	L	L1	F	R	Art. N°	TiAlN N [µk20]	HTA	HN [µk10]
1.0	0.4	7	5.5	3.0	0	643X10S-1.0	■ ■	□ □	
1.0	0.4	7	5.5	3.0	0.08	643X10S-1.0-R08	■ ■	□ □	

Tournage arrière
 Rückwärts drehen
 Back turning

643VX8

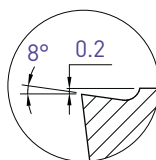

R

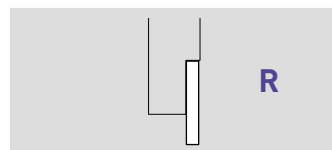
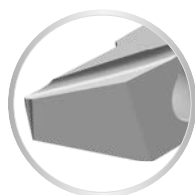
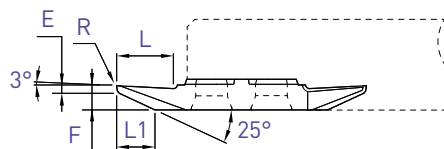
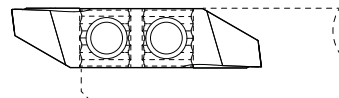

E	L	L1	F	R	Art. N°	TiAlN N [µk20]	HTA	HN [µk10]
-1	7.5	5.0	3.2	0	643VX8	■ ■	□ □	
-1	7.5	5.0	3.2	0.08	643VX8-R08	■ ■	□ □	

PRO-LINE

Tournage arrière
Rückwärts drehen
Back turning

633VX15 / 643VX15

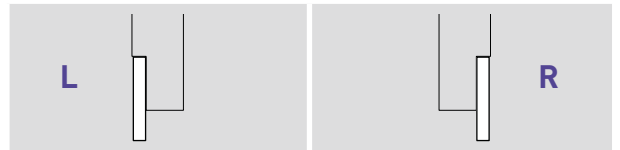
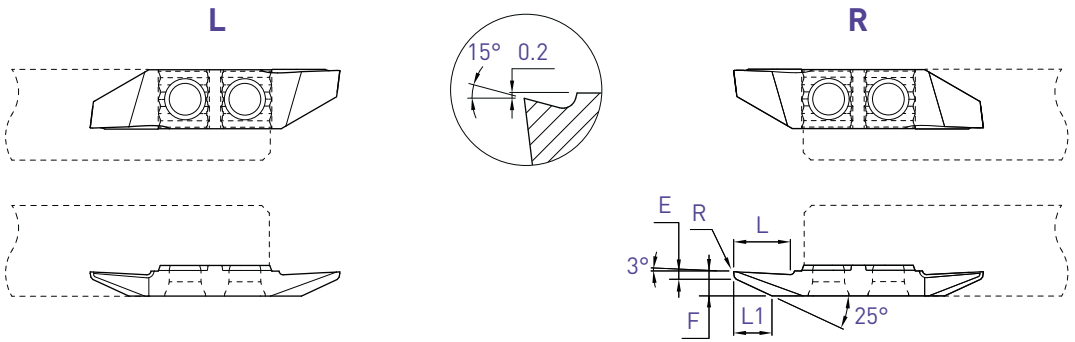

E	L	L1	F	R	Art. N°	TiAlN N [µk20]	HTA HN [µk10]	Art. N°	TiAlN N [µk20]	HTA HN [µk10]
0.5	7.5	5.2	3.2	0	633VX15	■ ■		643VX15	■ ■	□ □
0.5	7.5	5.2	3.2	0.08	-			643VX15-R08	■ ■	□ □

Tournage arrière
 Rückwärts drehen
 Back turning

643VUX

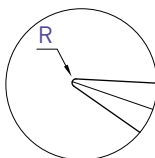
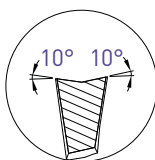

R

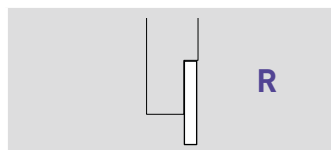
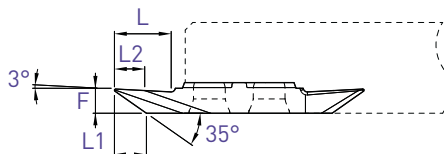
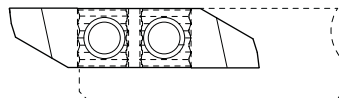

L	L1	L2	F	R	Art. N°	TiAlN N [µk20]	HTA	HN [µk10]
7.5	4.2	4.0	3.2	0.15	643VUX10-R15	■ ■	□ □	
7.5	3.8	3.8	3.2	0.35	643VUX10-R35	■ ■	□ □	

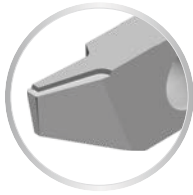
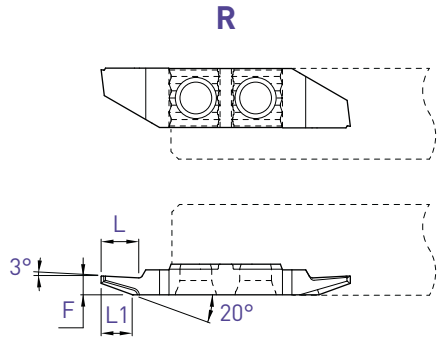
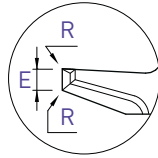
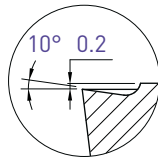

Pour un meilleur contrôle des copeaux
Für eine bessere Spankontrolle
For a better chip control

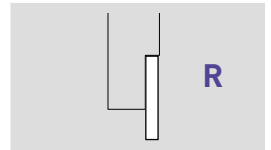

E	L	L1	F	R	Art. N°	TiAlN N (µk20)
1.0	5	4	2.5	0.01	643ZX10-1.0	■
1.0	5	4	2.5	0.08	643ZX10-1.0-R08	■

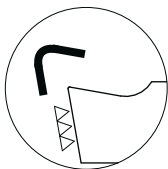

Arête de coupe honée
Gehonte Schneidkante
Honed edge

f min: 0.02 mm/U

Fonçage-tournage

Einstecken und drehen

Grooving and turning

634 / 644

L

R

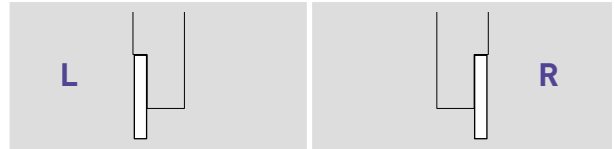
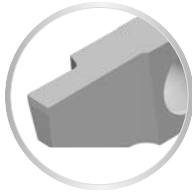
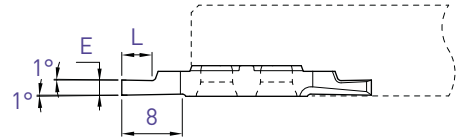
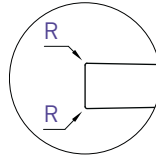
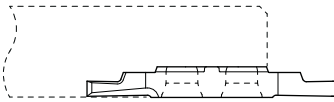
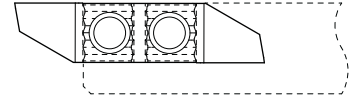
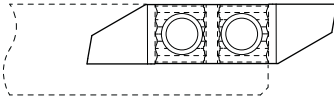

E	L	R	Art. N°	TiAlN	N (µk20)	HTA	HN (µk10)	Art. N°	TiAlN	N (µk20)	HTA	HN (µk10)
0.5	1.5	0	634-0.5	■	■			644-0.5	■	■	□	□
0.6	1.8	0	-					644-0.6	■	■	□	□
0.75	2	0	-					644-0.75	■	■	□	□
0.8	2	0	634-0.8	■	■			644-0.8	■	■	□	□
0.9	2.5	0	-					644-0.9	■	■	□	□
0.95	3	0	-					644-0.95	■	■	□	□
1.0	2.5	0	634-1.0	■	■			644-1.0	■	■	□	□
1.0	2.5	0.08	-					644-1.0-R08	■	■	□	□
1.2	3	0	634-1.2	■	■			644-1.2	■	■	□	□
1.2	3	0.08	-					644-1.2-R08	■	■	□	□
1.5	3	0	634-1.5	■	■			644-1.5	■	■	□	□
1.5	3	0.08	-					644-1.5-R08	■	■	□	□
1.5	3	0.15	-					644-1.5-R15	■	■	□	□
1.8	4	0	-					644-1.8	■	■	□	□
2.0	4	0	634-2.0	■	■			644-2.0	■	■	□	□
2.0	4	0.08	-					644-2.0-R08	■	■	□	□
2.0	4	0.15	-					644-2.0-R15	■	■	□	□
2.5	6	0	634-2.5	■	■			644-2.5	■	■	□	□
2.5	6	0.08	-					644-2.5-R08	■	■	□	□
2.5	6	0.15	-					644-2.5-R15	■	■	□	□
3	6	0	634-3.0	■	■			644-3.0	■	■	□	□
3	6	0.08	-					644-3.0-R08	■	■	□	□
3	6	0.15	-					644-3.0-R15	■	■	□	□

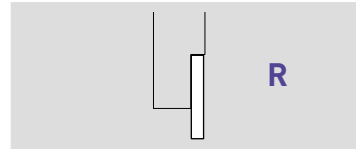
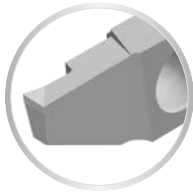
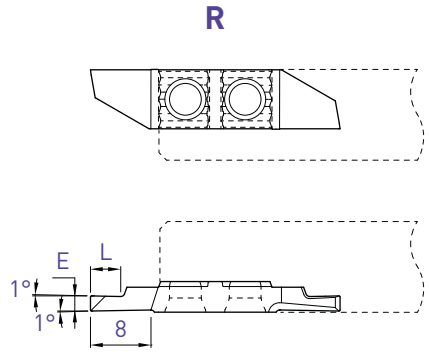
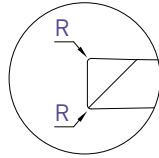
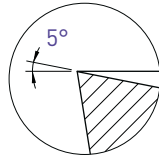

E	L	R	Art. N°	TiAlN N (µk20)	HTA	HN (µk10)
1.5	3	0.08	644X5-1.5-R08	■ ■	□ □	
2	4	0.08	644X5-2.0-R08	■ ■	□ □	
2	4	0.15	644X5-2.0-R15	■ ■	□ □	
2.5	6	0.08	644X5-2.5-R08	■ ■	□ □	
2.5	6	0.15	644X5-2.5-R15	■ ■	□ □	
3	6	0.08	644X5-3.0-R08	■ ■	□ □	
3	6	0.15	644X5-3.0-R15	■ ■	□ □	

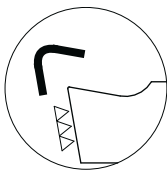
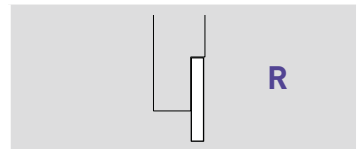

Arête de coupe honée
Gehonte Schneidkante
Honed edge

f min: 0.02 mm/U

E	L	R	Art. N°	TiAlN N (µk20)	HTA	HN (µk10)
1.5	3	0.08	644X5-1.5-R08-EP	■ ■		
2	4	0.08	644X5-2.0-R08-EP	■ ■		
2	4	0.15	644X5-2.0-R15-EP	■ ■		
2.5	6	0.08	644X5-2.5-R08-EP	■ ■		
2.5	6	0.15	644X5-2.5-R15-EP	■ ■		
3	6	0.08	644X5-3.0-R08-EP	■ ■		
3	6	0.15	644X5-3.0-R15-EP	■ ■		

Fonçage-tournage

Einstecken und drehen

Grooving and turning

634X10 / 644X10

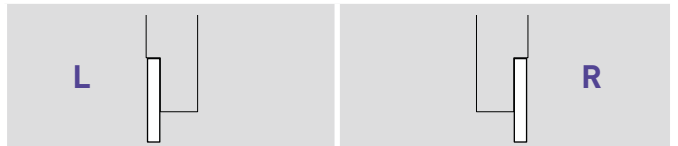
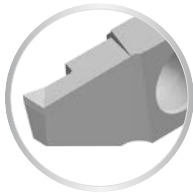
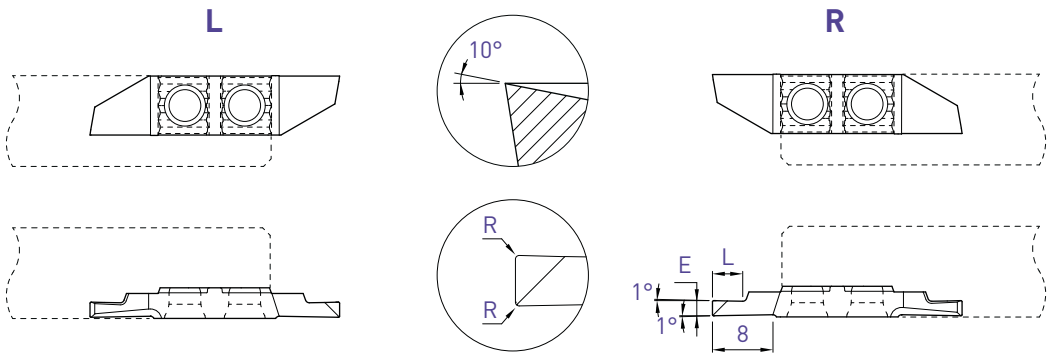

E	L	R	Art. N°	TiAlN N (µk20)	HTA HN (µk10)	Art. N°	TiAlN N (µk20)	HTA HN (µk10)
0.8	2	0	634X10-0.8	■ ■		644X10-0.8	■ ■ □ □	
1.0	2.5	0	634X10-1.0	■ ■		644X10-1.0	■ ■ □ □	
1.0	2.5	0.08	634X10-1.0-R08	■ ■		644X10-1.0-R08	■ ■ □ □	
1.2	3	0	-			644X10-1.2	■ ■ □ □	
1.2	3	0.08	-			644X10-1.2-R08	■ ■ □ □	
1.5	3	0	634X10-1.5	■ ■		644X10-1.5	■ ■ □ □	
1.5	3	0.08	634X10-1.5-R08	■ ■		644X10-1.5-R08	■ ■ □ □	
1.5	3	0.15	634X10-1.5-R15	■ ■		644X10-1.5-R15	■ ■ □ □	
1.8	4	0	-			644X10-1.8	■ ■ □ □	
2	4	0	634X10-2.0	■ ■		644X10-2.0	■ ■ □ □	
2	4	0.08	634X10-2.0-R08	■ ■		644X10-2.0-R08	■ ■ □ □	
2	4	0.15	634X10-2.0-R15	■ ■		644X10-2.0-R15	■ ■ □ □	
2.5	6	0	634X10-2.5	■ ■		644X10-2.5	■ ■ □ □	
2.5	6	0.08	634X10-2.5-R08	■ ■		644X10-2.5-R08	■ ■ □ □	
2.5	6	0.15	634X10-2.5-R15	■ ■		644X10-2.5-R15	■ ■ □ □	
3	6	0	634X10-3.0	■ ■		644X10-3.0	■ ■ □ □	
3	6	0.08	634X10-3.0-R08	■ ■		644X10-3.0-R08	■ ■ □ □	
3	6	0.15	634X10-3.0-R15	■ ■		644X10-3.0-R15	■ ■ □ □	

■ = disponible / verfügbar / available
 □ = selon disponibilité du stock / jenach Lagerverfügbarkeit / depending on stock availability

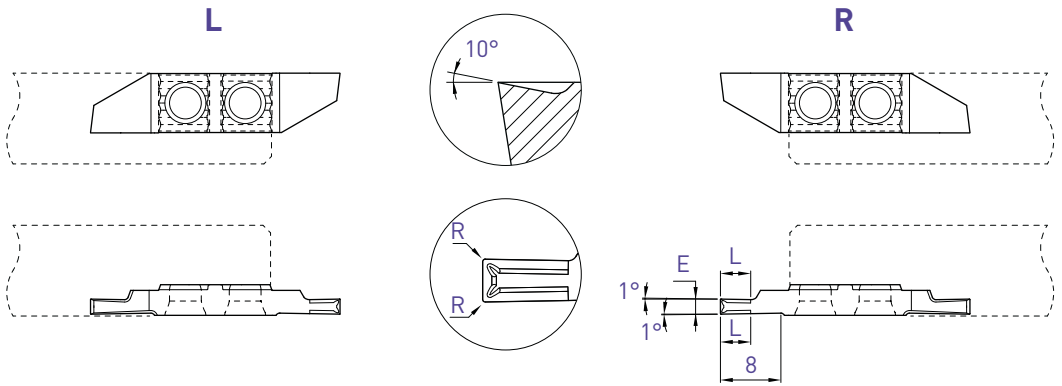

Pour un meilleur contrôle des copeaux
Für eine bessere Spankontrolle
For a better chip-control

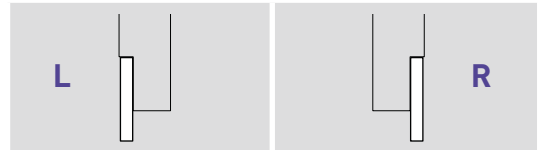

E	L	R	Art. N°	TiAlN N (µk20)	Art. N°	TiAlN N (µk20)
1.0	2.5	0.01	634ZXB10-1.0	■	644ZXB10-1.0	■
1.5	4	0.01	634ZXB10-1.5	■	644ZXB10-1.5	■
1.5	4	0.08	634ZXB10-1.5-R08	■	644ZXB10-1.5-R08	■
2.0	4	0.01	634ZXB10-2.0	■	644ZXB10-2.0	■
2.0	4	0.08	634ZXB10-2.0-R08	■	644ZXB10-2.0-R08	■
2.0	4	0.15	634ZXB10-2.0-R15	■	644ZXB10-2.0-R15	■
2.5	5	0.08	634ZXB10-2.5-R08	■	644ZXB10-2.5-R08	■
2.5	5	0.15	634ZXB10-2.5-R15	■	644ZXB10-2.5-R15	■
3.0	6	0.08	634ZXB10-3.0-R08	■	644ZXB10-3.0-R08	■
3.0	6	0.15	634ZXB10-3.0-R15	■	644ZXB10-3.0-R15	■
3.0	6	0.35	634ZXB10-3.0-R35	■	644ZXB10-3.0-R35	■

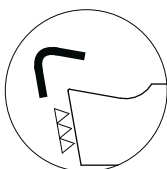

Arête de coupe honée
Gehonte Schneidkante
Honed edge

f min: 0.02 mm/U

Fonçage-tournage

Einstecken und drehen

Grooving and turning

634ZXT / 644ZXT

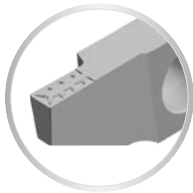
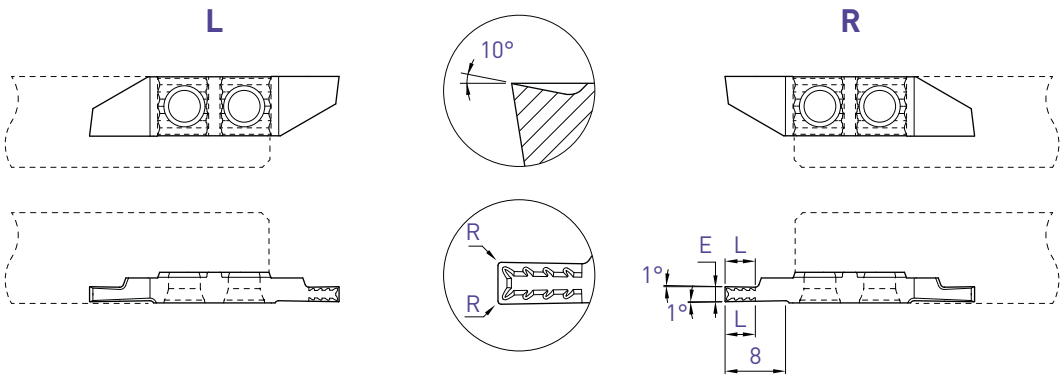

Pour un meilleur contrôle des copeaux
Für eine bessere Spankontrolle
For a better chip-control

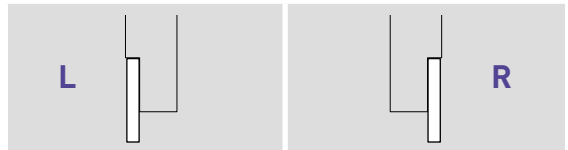

E	L	R	Art. N°	TiAlN N (µm20)	Art. N°	TiAlN N (µm20)
1.0	2.5	0.01	634ZXT10-1.0	■	644ZXT10-1.0	■
1.5	4	0.01	634ZXT10-1.5	■	644ZXT10-1.5	■
1.5	4	0.08	634ZXT10-1.5-R08	■	644ZXT10-1.5-R08	■
2.0	4	0.01	634ZXT10-2.0	■	644ZXT10-2.0	■
2.0	4	0.08	634ZXT10-2.0-R08	■	644ZXT10-2.0-R08	■
2.0	4	0.15	634ZXT10-2.0-R15	■	644ZXT10-2.0-R15	■
2.5	5	0.08	634ZXT10-2.5-R08	■	644ZXT10-2.5-R08	■
2.5	5	0.15	634ZXT10-2.5-R15	■	644ZXT10-2.5-R15	■
3.0	6	0.08	634ZXT10-3.0-R08	■	644ZXT10-3.0-R08	■
3.0	6	0.15	634ZXT10-3.0-R15	■	644ZXT10-3.0-R15	■
3.0	6	0.35	-		644ZXT10-3.0-R35	■

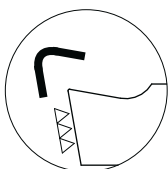

Arête de coupe honée
Gehonte Schneidkante
Honed edge

f min: 0.02 mm/U

Chanfreinage

Anfasen

Chamfering

635-90 / 645-90

L

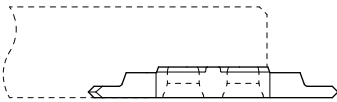
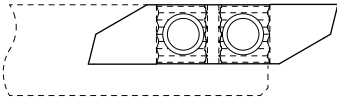

R

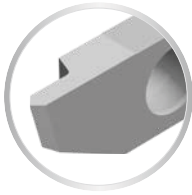
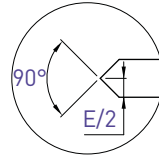
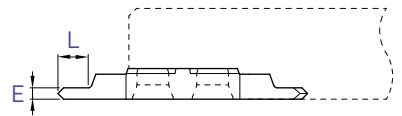
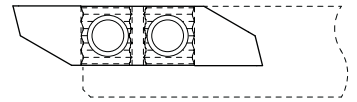

L

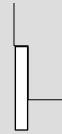

R



E	L	Art. N°	TiAlN N (µk20)	Art. N°	TiAlN N (µk20)
1.5	4	635-90-1.5	■ ■	645-90-1.5	■ ■

Chanfreinage

Anfasen

Chamfering

635X-90 / 645X-90

L

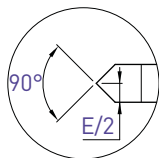
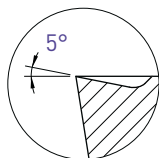
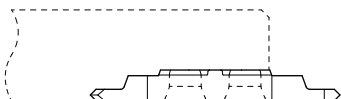
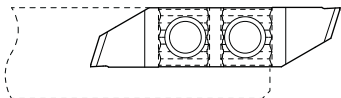

R

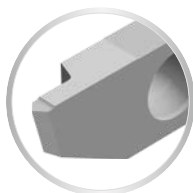
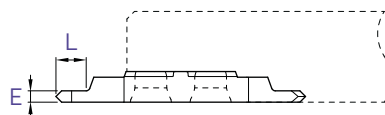
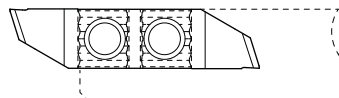

L



R



E	L	Art. N°	TiAlN N (µk<20)	Art. N°	TiAlN N (µk<20)
1.5	4	635X5-90-1.5	■ ■	645X5-90-1.5	■ ■

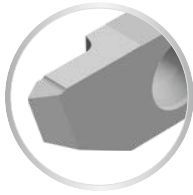
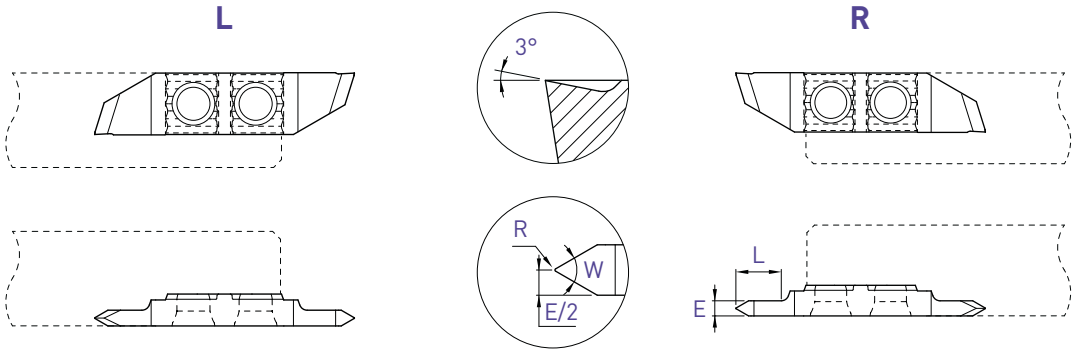

Profil partiel
Teilprofil
Partial profile

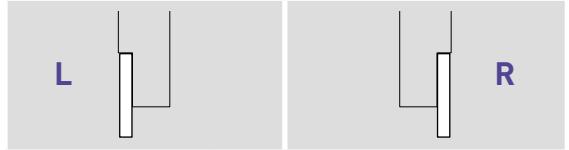

W	E	L	R	Art. N°	TiAlN N (µk20)	Art. N°	TiAlN N (µk20)
55°	1.5	4	0	636X3-55-1.5	■ ■	646X3-55-1.5	■ ■
55°	2.0	6	0.03	636X3-55-2.0-R03	■ ■	646X3-55-2.0-R03	■ ■
60°	1.5	4	0	636X3-60-1.5	■ ■	646X3-60-1.5	■ ■
60°	2.0	6	0.03	636X3-60-2.0-R03	■ ■	646X3-60-2.0-R03	■ ■
60°	2.0	6	0.06	636X3-60-2.0-R06	■ ■	646X3-60-2.0-R06	■ ■
60°	3.0	8	0.06	636X3-60-3.0-R06	■ ■	646X3-60-3.0-R06	■ ■
60°	3.0	8	0.12	636X3-60-3.0-R12	■ ■	646X3-60-3.0-R12	■ ■

Filetage

Gewinde drehen

Threading

636X-M / 646X-M

L

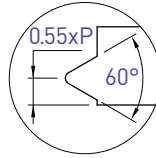
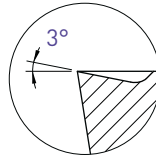
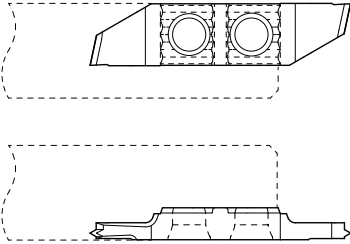

R

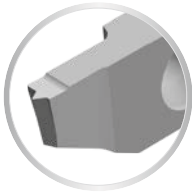
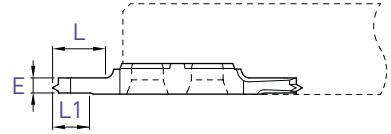
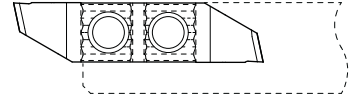

Profil complet métrique
Metrisches Vollprofil
Metric full profile

L

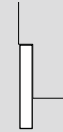

R



E	L	L1	Pas Steigung Pitch P	Art. N°	TiAlN N (µk20)	Art. N°	TiAlN N (µk20)
1.0	3	3	0.25	636X3-M-0.25	■ ■	646X3-M-0.25	■ ■
1.0	3	3	0.30	636X3-M-0.30	■ ■	646X3-M-0.30	■ ■
1.0	3	3	0.35	636X3-M-0.35	■ ■	646X3-M-0.35	■ ■
1.0	3	3	0.40	636X3-M-0.40	■ ■	646X3-M-0.40	■ ■
1.0	3	3	0.45	636X3-M-0.45	■ ■	646X3-M-0.45	■ ■
1.0	3	3	0.50	636X3-M-0.50	■ ■	646X3-M-0.50	■ ■
1.5	5	5	0.60	636X3-M-0.60	■ ■	646X3-M-0.60	■ ■
1.5	5	5	0.70	636X3-M-0.70	■ ■	646X3-M-0.70	■ ■
1.5	5	5	0.75	636X3-M-0.75	■ ■	646X3-M-0.75	■ ■
1.5	5	5	0.80	636X3-M-0.80	■ ■	646X3-M-0.80	■ ■
2.0	7	5	1.00	636X3-M-1.00	■ ■	646X3-M-1.00	■ ■
2.0	7	5	1.25	636X3-M-1.25	■ ■	646X3-M-1.25	■ ■
2.0	7	5	1.50	636X3-M-1.50	■ ■	646X3-M-1.50	■ ■

■ = disponible / verfügbar / available

□ = selon disponibilité du stock / jenach Lagerverfügbarkeit / depending on stock availability

PRO-LINE

Plaquettes à rayon
 Radius Wendeplatten
 Radius inserts

637 / 647

L

R

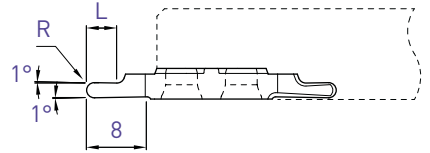
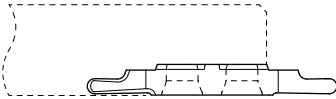
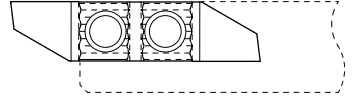
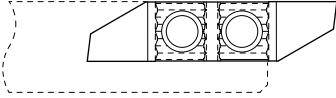

L

R

R	L	Art. N°	TiAlN N (µk20)	HTA HN (µk10)	Art. N°	TiAlN N (µk20)	HTA HN (µk10)
0.25	1.5	-			647-R0.25	■ ■	
0.40	2	-			647-R0.4	■ ■	
0.5	2.5	637-R0.5	■ ■		647-R0.5	■ ■ □ □	
0.6	2.5	-			647-R0.6	■ ■	
0.75	3	-			647-R0.75	■ ■	
0.8	3	-			647-R0.8	■ ■	
1.0	4	637-R1.0	■ ■		647-R1.0	■ ■	
1.5	6	-			647-R1.5	■ ■	

Plaquettes à rayon
 Radius Wendepplatten
 Radius inserts

647ZX10

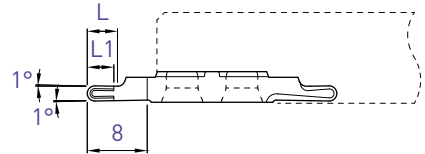
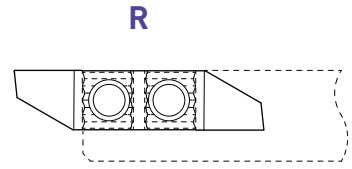
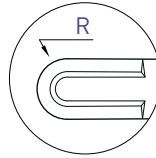
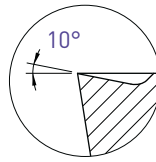

Pour un meilleur contrôle des copeaux
 Für eine bessere Spankontrolle
 For a better chip-control

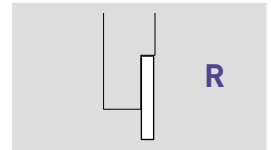

R	L	L1	Art. N°	TiAlN N (µk20)
1.0	4	3.5	647ZX10-R1.0	■
1.5	6	4	647ZX10-R1.5	■

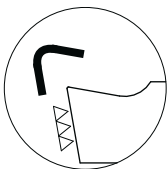

Arête de coupe honée
 Gehonte Schneidkante
 Honed edge

f min: 0.02 mm/U

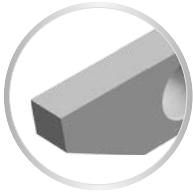
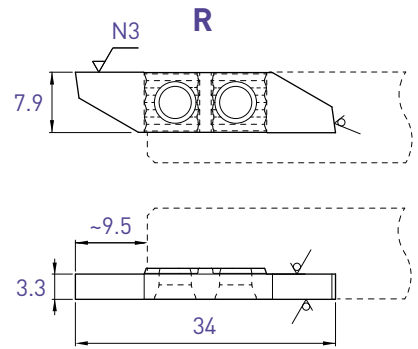
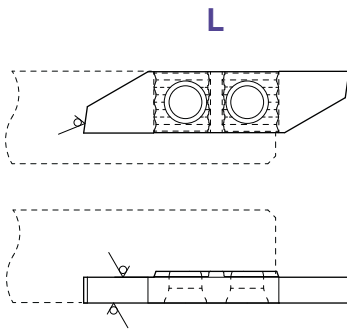

Face de coupe polie
 Polierte Schneidfläche
 Polished cutting face

L			R		
Art. N°	TiAlN N (µk20)	HTA HN (µk10)	Art. N°	TiAlN N (µk20)	HTA HN (µk10)
631-EP	■ ■	■ ■	641-EP	■ ■	■ ■

Porte-outils

Halter

Holder

650 / 660

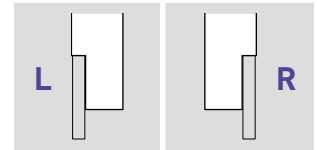
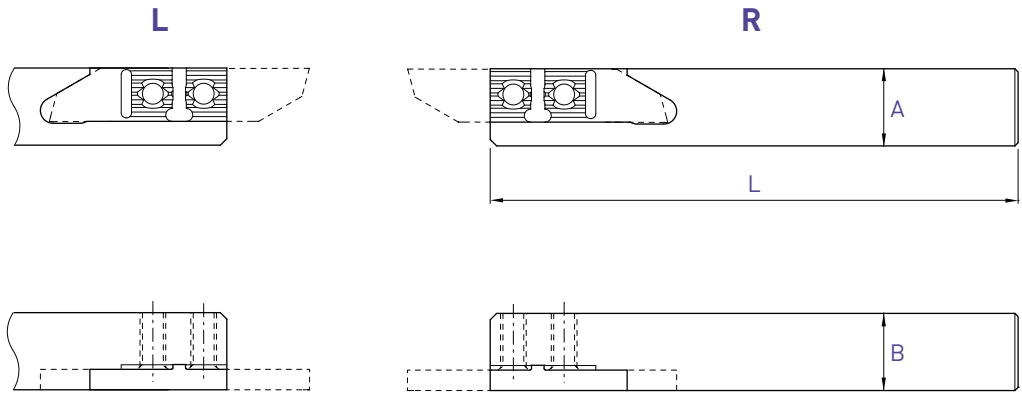

A x B	L	Art. N°	Art. N°
8 x 8	115	650-8	660-8
10 x 10	115	650-10	660-10
10 x 10	50	650-10-50	660-10-50
12 x 12	130	650-12	660-12
12 x 12	90	650-12-90	660-12-90
12.7 x 12.7	130	650-12.7	660-12.7
16 x 16	130	650-16	660-16
16 x 16	75	650-16-75	660-16-75
20 x 20	120	650-20	660-20

Chaque support est livré avec vis et clé.

Jeder Halter wird mit Spannschraube(n) und Schlüssel geliefert.

Screw(s) and key are included with each tool holder.

■ = disponible / verfügbar / available

□ = selon disponibilité du stock / jenach Lagerverfügbarkeit / depending on stock availability

Porte-outils

Halter

Holder

Coupe à droite déportée

Versetztes Rechtsschneiden

Right cut off line

650-RC

Utiliser des plaquettes type 651R
WSP Typ 651R verwenden
Use inserts type 651R

Voir dès page 3.39
Siehe ab Seite 3.39
See from page 3.39

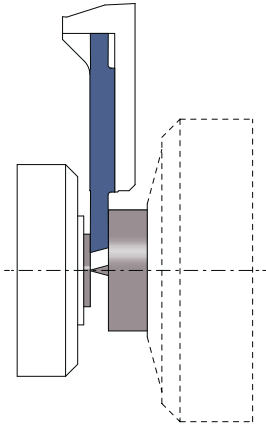
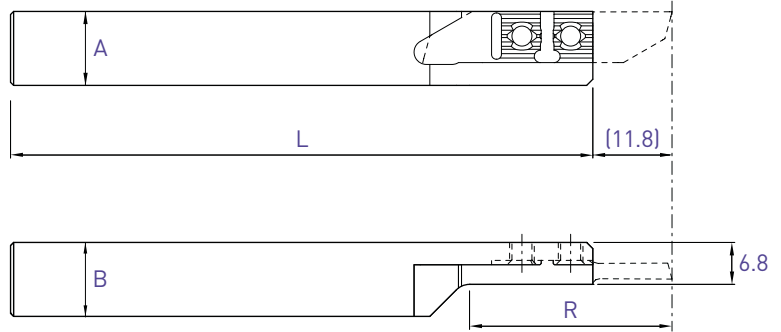

 L (R) Coupe à droite déportée Versetztes Rechtsschneiden Right cut off line			
A x B	R	L	Art. N°
10 x 10	32	115	650RC-10
12 x 12	32	130	650RC-12
16 x 16	42	130	650RC-16

Chaque support est livré avec vis et clé.
Jeder Halter wird mit Spannschraube(n) und Schlüssel geliefert.
Screw(s) and key are included with each tool holder.

Porte-outils avec arrosage intégré
 Halter mit integrierter Kühlmittelzufuhr
 Holders with integrated coolant supply

650-JET / 660-JET

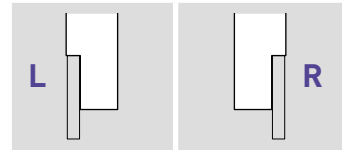
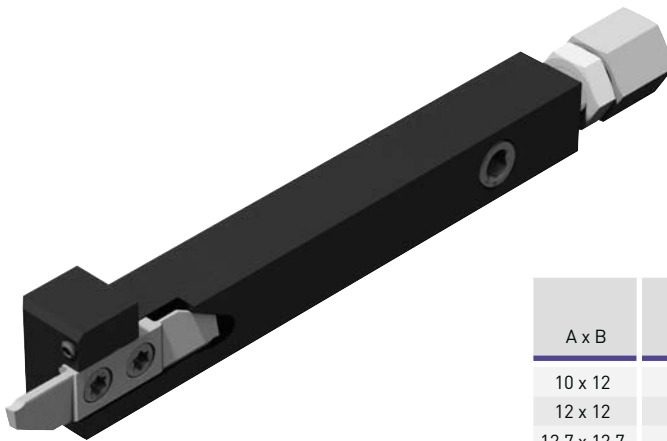
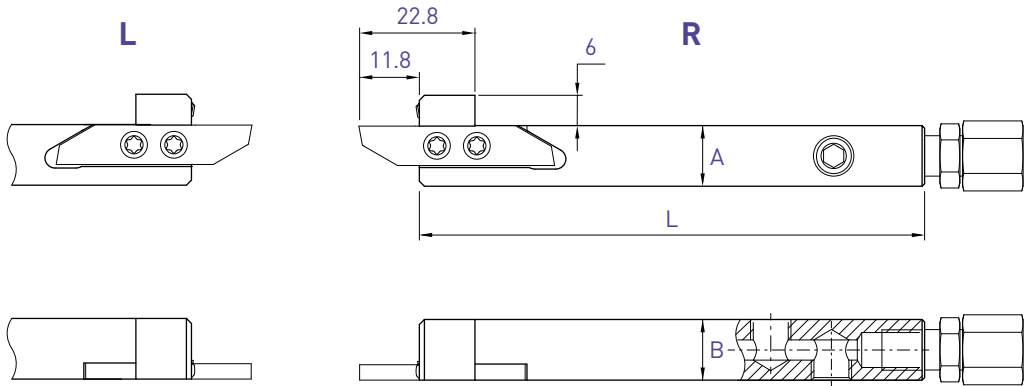

A x B	L	Art. N°	Art. N°
10 x 12	100	650-1012-JET	660-1012-JET
12 x 12	100	650-12-JET	660-12-JET
12.7 x 12.7	100	650-12.7-JET	660-12.7-JET
16 x 16	100	650-16-JET	660-16-JET
20 x 20	100	650-20-JET	660-20-JET

Chaque support est livré avec vis, clé, raccord droit et buse d'arrosage Ø 1.5 mm.

Jeder Halter wird mit Spannschraube(n), Schlüssel, gerader Kühlmittelanschluss und Kühlmitteldüse Ø 1.5 mm geliefert.

Screw(s), key, straight connector and coolant nozzle Ø 1.5 mm are included with each tool holder.

L

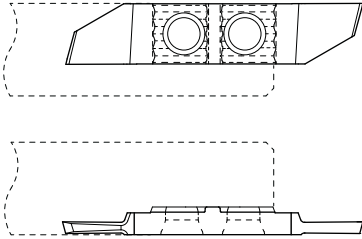

R

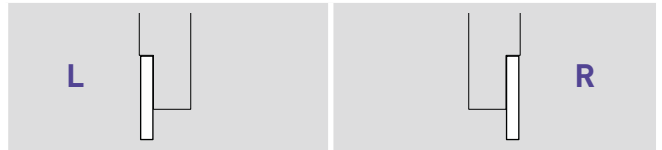
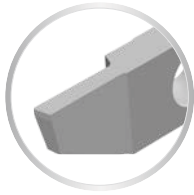
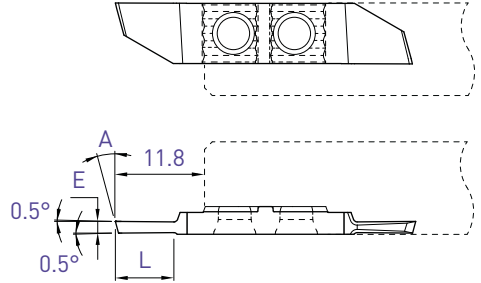

E	A	L	Art. N°	TiAlN N (µk20)	HTA HN (µk10)	Art. N°	TiAlN N (µk20)	HTA HN (µk10)
0.8	20°	5	651-0.8-20°	■ ■		661-0.8-20°	■ ■	□ □
1.0	15°	5	-			661-1.0-15°	■ ■	□ □
1.0	20°	5	651-1.0-20°	■ ■		661-1.0-20°	■ ■	□ □
1.2	15°	5	-			661-1.2-15°	■ ■	□ □
1.2	20°	5	651-1.2-20°	■ ■		661-1.2-20°	■ ■	□ □
1.5	15°	7.5	651-1.5-15°	■ ■		661-1.5-15°	■ ■	□ □
1.5	20°	7.5	-			661-1.5-20°	■ ■	□ □
1.8	15°	9	651-1.8-15°	■ ■		661-1.8-15°	■ ■	□ □
2.0	15°	11	651-2.0-15°	■ ■		661-2.0-15°	■ ■	□ □
2.5	15°	11	651-2.5-15°	■ ■		661-2.5-15°	■ ■	□ □

Tronçonnage

Abstechen

Parting off

651XF / 661XF

L

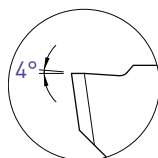
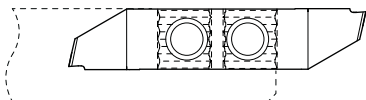

R

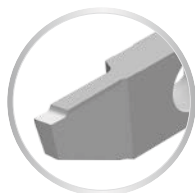
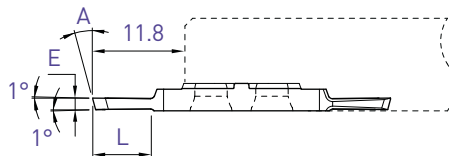
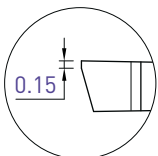
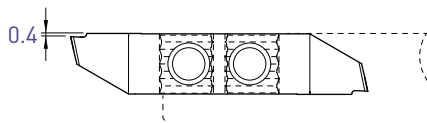

L

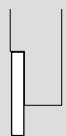

R



E	A	L	Art. N°	TiAlN N [µk20]	HTA HN [µk10]	Art. N°	TiAlN N [µk20]	HTA HN [µk10]
1.5	15°	7.5	651XF-1.5	■ ■		661XF-1.5	■ ■	□ □
2.0	15°	11	651XF-2.0	■ ■		661XF-2.0	■ ■	□ □

Tronçonnage
Abstechen
Parting off

651X12 / 661X12

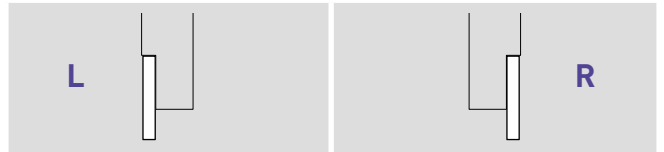
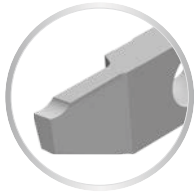
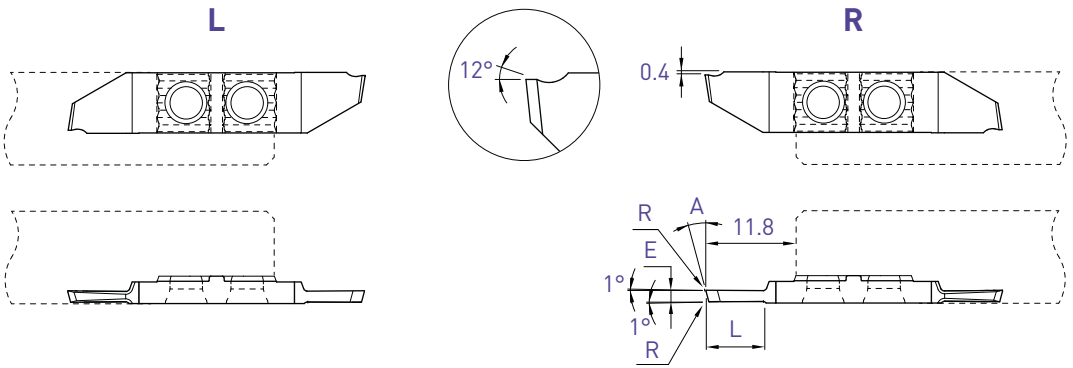

E	A	L	R	Art. N°	TiAlN N [µk20]	HTA HN [µk10]	Art. N°	TiAlN N [µk20]	HTA HN [µk10]
1.0	15°	5	0.03	651X12-1.0	■ ■		661X12-1.0	■ ■	□ □
1.5	15°	7.5	0.03	651X12-1.5	■ ■		661X12-1.5	■ ■	□ □
2.0	15°	11	0.03	651X12-2.0	■ ■		661X12-2.0	■ ■	□ □

Tronçonnage

Abstechen

Parting off

651U / 661U

L

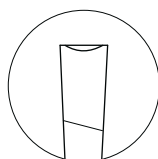
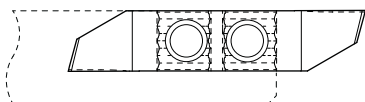

R

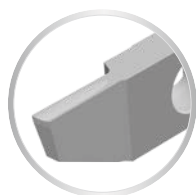
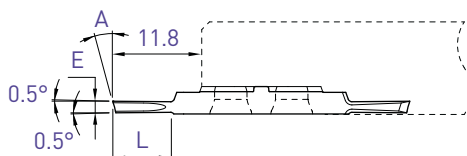
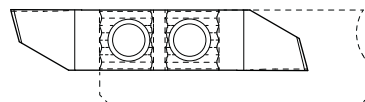

L

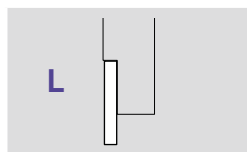

R

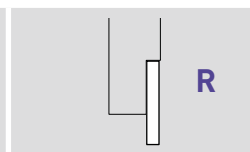

E	A	L	Art. N°	TiAlN N (µk20)	Art. N°	TiAlN N (µk20)
1.5	15°	7.5	651U-1.5	■ ■	661U-1.5	■ ■
2.0	15°	11	651U-2.0	■ ■	661U-2.0	■ ■

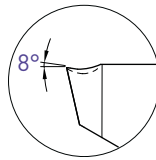

0.2

R

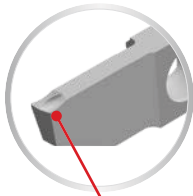
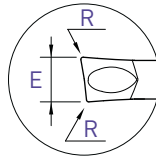
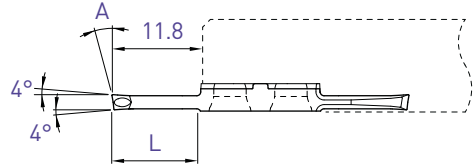

Pour un meilleur contrôle des copeaux
Für eine bessere Spankontrolle
For a better chip-control

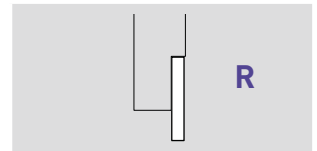
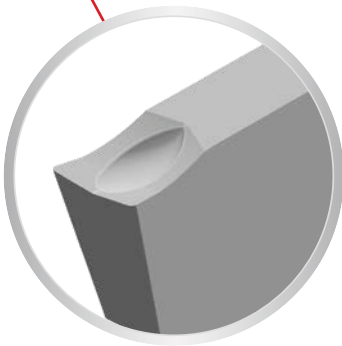

E	A	L	R	Art. N°	TiAlN N (µm20)
2.0	8°	11	0.10	661ZU8-2.0-8°-R10	■

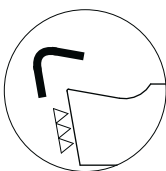

Arête de coupe honée
Gehonte Schneidkante
Honed edge

f min: 0.02 mm/U

Tronçonnage
Abstechen
Parting off

Coupe déportée
Versetzttes Schneiden
Cut off line

651R

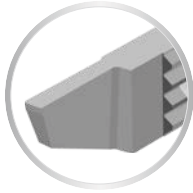

Cut R

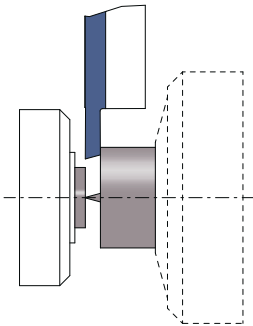
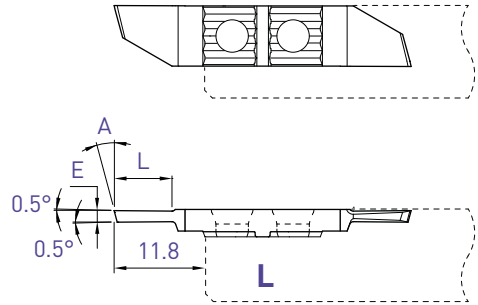

L (R)

Coupe à droite déportée
Versetzttes Rechtsschneiden
Right cut off line

E	A	L	Art. N°	Ti/AlN N (µk20)	HTA	HN (µk10)
1.0	15°	5	651R-1.0-15°	■ ■	□ □	
1.2	15°	5	651R-1.2-15°	■ ■	□ □	
1.5	15°	7.5	651R-1.5-15°	■ ■	□ □	
2.0	15°	11	651R-2.0-15°	■ ■	□ □	
2.5	15°	11	651R-2.5-15°	■ ■	□ □	

Tronçonnage
 Abstechen
 Parting off

Coupe déportée
 Versetztes Schneiden
 Cut off line

651RXF

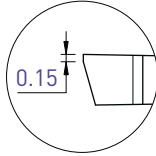
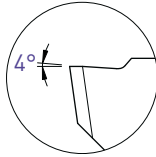
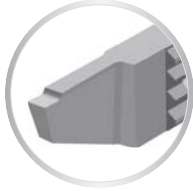

Cut R

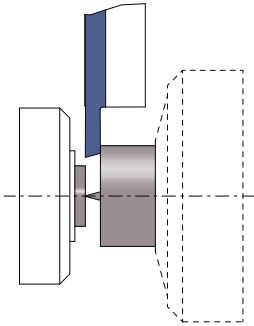
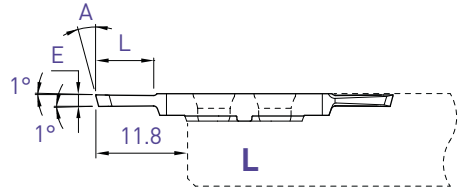
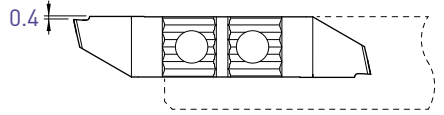

L (R)

Coupe à droite déportée
 Versetztes Rechtsschneiden
 Right cut off line

E	A	L	Art. N°	Ti/AIN N (µk20)	HTA	HN (µk10)
1.5	15°	7.5	651RXF-1.5	■ ■	□ □	
2.0	15°	11	651RXF-2.0	■ ■	□ □	

Tronçonnage

Abstechen

Parting off

Coupe déportée

Versetztes Schneiden

Cut off line

651RX12

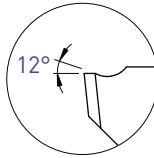
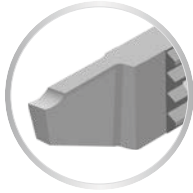

Cut R

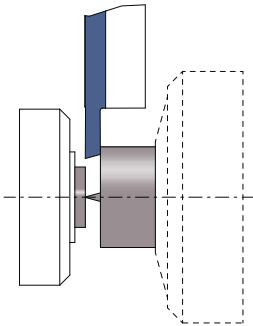
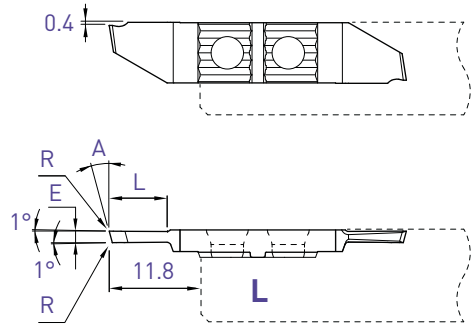

L (R)

Coupe à droite déportée
Versetztes Rechtsschneiden
Right cut off line

E	A	L	R	Art. N°	Ti/AIN N (µk20)	HTA	HN (µk10)
1.5	15°	7.5	0.03	651RX12-1.5	■ ■	□ □	
2.0	15°	11	0.03	651RX12-2.0	■ ■	□ □	

Tronçonnage
 Abstechen
 Parting off

Coupe déportée
 Versetztes Schneiden
 Cut off line

651RU

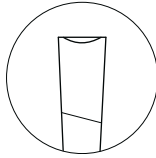
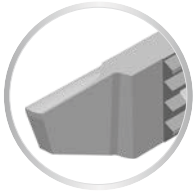

Cut R

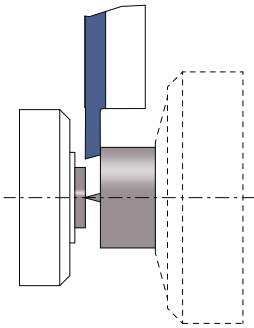
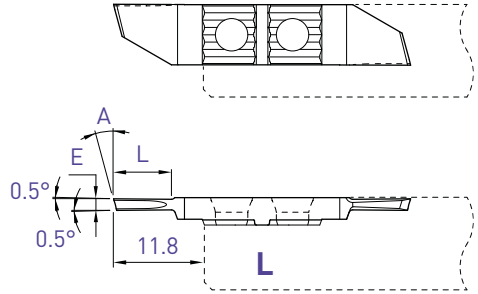

L (R)

Coupe à droite déportée
 Versetztes Rechtsschneiden
 Right cut off line

E	A	L	Art. N°	TiAlN N (µk20)
1.5	15°	7.5	651RU-1.5	■ ■
2.0	15°	11	651RU-2.0	■ ■

Tronçonnage
Abstechen
Parting off

Coupe déportée
Versetztes Schneiden
Cut off line

651RZU

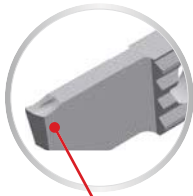
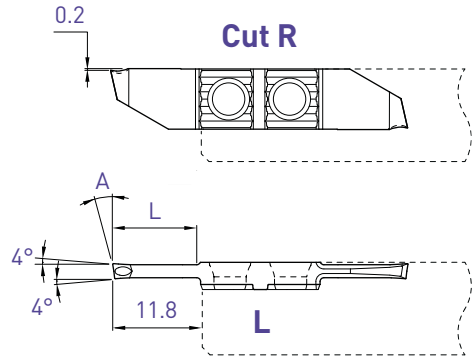
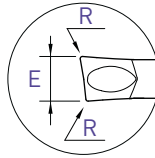
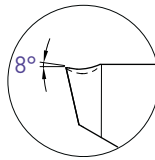

Pour un meilleur contrôle des copeaux
Für eine bessere Spankontrolle
For a better chip control

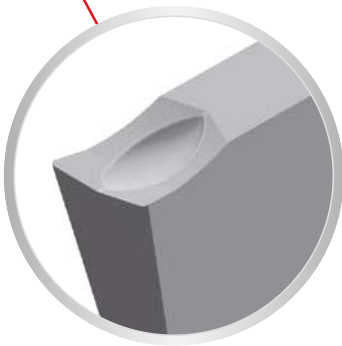

L (R)

Coupe à droite déportée
Versetztes Rechtsschneiden
Right cut off line

E	A	L	R	Art. N°	TiAlN N (µm20)
2.0	8°	11	0.10	651RZU8-2.0-8°-R10	■

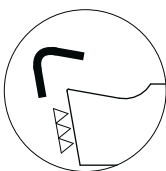

Arête de coupe honée
Gehonte Schneidkante
Honed edge

f min: 0.02 mm/U

L

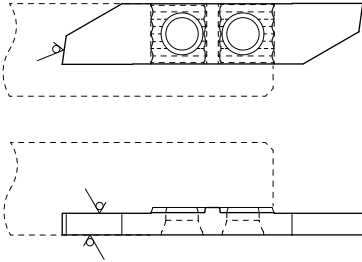

R

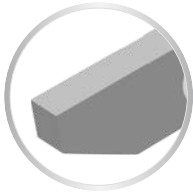
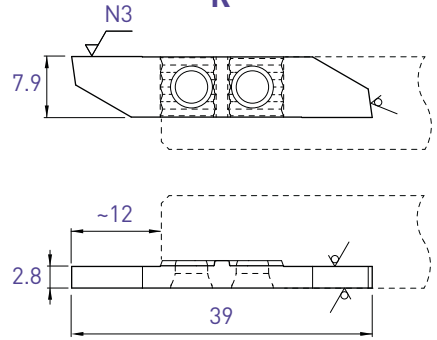







Face de coupe polie
 Polierte Schneidfläche
 Polished cutting face

L				R					
Art. N°	TiAlN	N (µk20)	HTA	HN (µk10)	Art. N°	TiAlN	N (µk20)	HTA	HN (µk10)
651-EP	■	■	■	■	661-EP	■	■	■	■

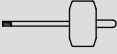
Pièces de rechange et accessoires

Ersatzteile und Zubehöre

Spare parts and accessories

Pièces de rechange Ersatzteile Spare parts						Accessoires Zubehöre Accessories	
Porte-outils Halter Holders			 	 		Option Art. N°	Recommandation de serrage Drehmoment Empfehlung Clamping recommendation
630 640			-	-	-		
630-JET 640-JET	V-M4X9-T15		J-M8X1-D6	JB-M8X1	JJ-M3X6-D1.5		
650 660		C-T15	-	-	-	SET-NM-TX15	3 Nm
650-RC	V-M4X6.5-T15		-	-	-		
650-JET 660-JET	V-M4X9-T15		J-M8X1-D6	JB-M8X1	JJ-M3X6-D1.5		



SET-NM-TX15



261

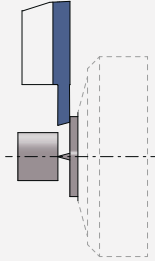

261R

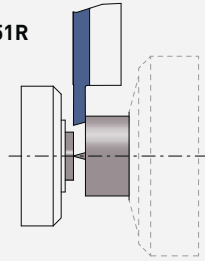

262

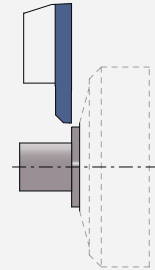

263

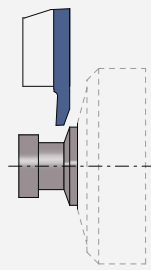

264

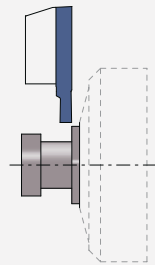

266

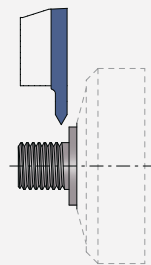

Index

Nuances
Sorten
Grades > 4.02

Paramètres de coupe indicatifs Empfohlene Schnittwerte Standard machining data	Accessoires Zubehör Accessories	> 4.03
--	---------------------------------------	--------

Porte-outils
Halter
Holders > 4.04



Tronçonnage
Abstechen
Parting off **Type 251 / 261** > 4.08

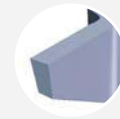

Tournage avant
Vorwärts drehen
Front turning **Type 252 / 262** > 4.10

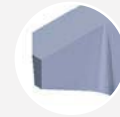

Tournage arrière
Rückwärts drehen
Back turning **Type 253 / 263** > 4.11



Fonçage-tournage
Einstechen und drehen
Grooving and turning **Type 254 / 264** > 4.14



Filetage
Gewinde drehen
Threading **Type 256 / 266** > 4.16

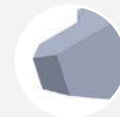

Plaquettes ébauches
WSP-Rohlinge
Blank inserts **Type 251E / 261E** > 4.17

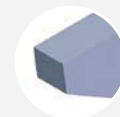

<h3>AP302</h3> <p>μK20 + revêtement PVD μK20 + PVD Beschichtung μK20 + PVD coating</p>	<h3>AP202</h3> <p>μK20 + revêtement PVD μK20 + PVD Beschichtung μK20 + PVD coating</p>	<h3>N (μK20)</h3> <p>non revêtu unbeschichtet uncoated</p>
<ul style="list-style-type: none"> excellente nuance universelle 1^{er} choix pour l'usinage des aciers, aciers inoxydables et alliages de titane très bonne résistance à la température 	<ul style="list-style-type: none"> nuance particulièrement adaptée aux faibles vitesses de coupe 	<ul style="list-style-type: none"> nuance micro-grain tenace supporte les coupes interrompues et autres conditions d'usinage défavorables
<ul style="list-style-type: none"> beste Universalsorte für die Bearbeitung von Stahl, rostfreiem Stahl und Titanlegierungen bestens geeignet sehr gute Warmfestigkeit 	<ul style="list-style-type: none"> besonders geeignete Sorte für niedrige Schnittgeschwindigkeiten 	<ul style="list-style-type: none"> zähe Feinkornsorte für unterbrochene Schnitte und andere ungünstige Bearbeitungsbedingungen geeignet
<ul style="list-style-type: none"> best universal grade first choice for steel, stainless steel and titanium alloys machining very good heat resistance 	<ul style="list-style-type: none"> grade particularly suitable for low cutting speeds 	<ul style="list-style-type: none"> tough micro-grain grade suitable for interrupted cut and other unfavourable machining conditions

<h3>AH302</h3> <p>μK10 + revêtement PVD μK10 + PVD Beschichtung μK10 + PVD coating</p>	<h3>HN (μK10)</h3> <p>non revêtu unbeschichtet uncoated</p>
<ul style="list-style-type: none"> nuance très résistante à l'usure pour l'usinage en finition dans des conditions favorables des aciers, aciers inoxydables et alliages de titane 	<ul style="list-style-type: none"> nuance micro-grain très résistante à l'usure recommandé pour l'usinage du titane faiblement allié déconseillé en cas de coupe interrompue et autres conditions d'usinage défavorables
<ul style="list-style-type: none"> sehr verschleißfeste Sorte für die Feinbearbeitung von Stahl, rostfreiem Stahl und Titanlegierungen bei guten Bearbeitungsbedingungen 	<ul style="list-style-type: none"> verschleißfeste Feinkornsorte für die Bearbeitung von niedrig legiertem Titan empfehlenswert für unterbrochene Schnitte und andere ungünstige Bearbeitungsbedingungen nicht geeignet
<ul style="list-style-type: none"> very wear resistant grade for light machining of steel, stainless steel and titanium alloys under favourable machining conditions 	<ul style="list-style-type: none"> wear resistant micro-grain grade suitable for the machining of low alloyed titanium not suitable for interrupted cut and other unfavourable machining conditions

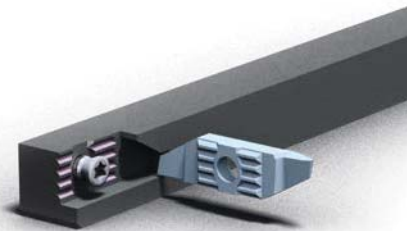

Patented rigid clamping system

Paramètres de coupe indicatifs

Empfohlene Schnittwerte

Standard machining data

Matière Werkstoff Material		Tournage Drehen Turning		Tronçonnage Abstechen Parting off	
		VC (m/min)	F (mm/U)	VC (m/min)	F (mm/U)
Acier de décolletage Automatenstahl Free-cutting steel	P	120 - 200	0.01 - 0.20	80 - 150	0.01 - 0.15
Acier Stahl Steel	P	< 600 N/mm ² 80 - 160	0.01 - 0.18	70 - 120	0.01 - 0.12
Acier Stahl Steel	P	< 800 N/mm ² 60 - 120	0.01 - 0.15	60 - 100	0.01 - 0.10
Acier Stahl Steel	P	> 800 N/mm ² 50 - 100	0.01 - 0.12	40 - 80	0.01 - 0.08
Acier inoxydable Rostfreistahl Stainless steel	M	60 - 120	0.01 - 0.15	60 - 100	0.01 - 0.08
Aluminium	N	180 - 800	0.01 - 0.30	150 - 300	0.01 - 0.20
Cuivre, laiton, bronze Kupfer, Messing, Bronze Copper, brass, bronze	N	100 - 500	0.01 - 0.30	100 - 300	0.01 - 0.20
Titane Titan Titanium	S	30 - 70	0.01 - 0.12	30 - 50	0.01 - 0.06

Accessoires

Zubehöre

Accessories

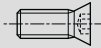
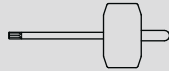
Porte-outils Halter Holders			Option Art. N°
250-8 / 260-8	V-M3.5X7.3-T15	C-T15	SET-NM-TX15
250-... / 260-...	V-M4X9-T15		
250RC / 260-C	V-M4X7.3-T15		

Recommandation de serrage
Drehmoment Empfehlung
Clamping recommendation

3.0 Nm



SET-NM-TX15

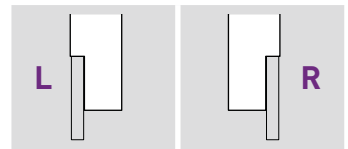
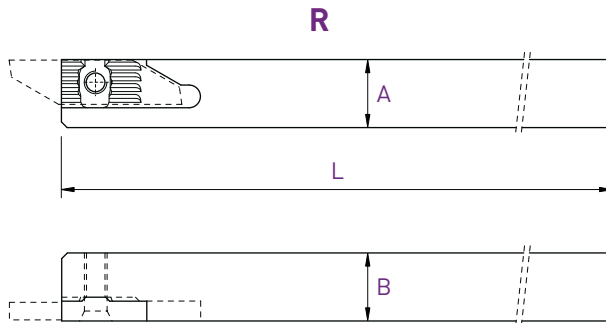

A x B	L	Art. N°	Art. N°
8 x 8	115	250-8	260-8
10 x 10	115	250-10	260-10
12 x 12	130	250-12	260-12
12 x 12	90	250-12-90	260-12-90
12.7 x 12.7	130	250-12.7	260-12.7
16 x 16	130	250-16	260-16
16 x 16	75	250-16-75	260-16-75
20 x 20	120	250-20	260-20

Chaque support est livré avec vis et clé.
 Jeder Halter wird mit Spannschraube(n) und Schlüssel geliefert.
 Screw(s) and key are included with each tool holder.

Porte-outils

Halter

Holder

260-C

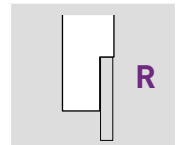
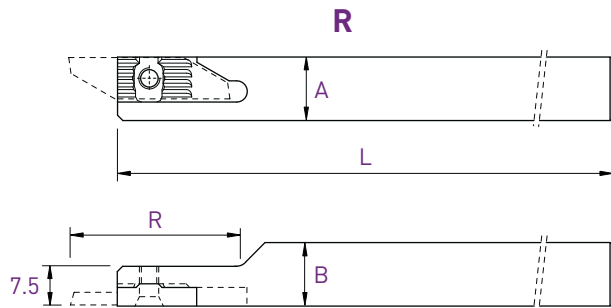
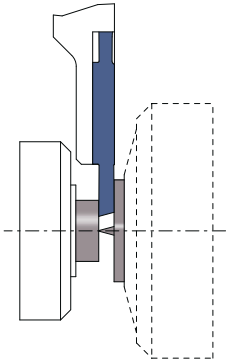

A x B	L	R	Art. N°
12 x 12	130	30	260-C-12

Porte-outils

Halter

Holder

Coupe à droite déportée
Versetzes Rechtsschneiden
Right cut off line

250RC

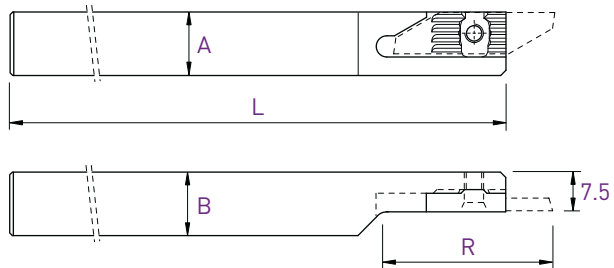
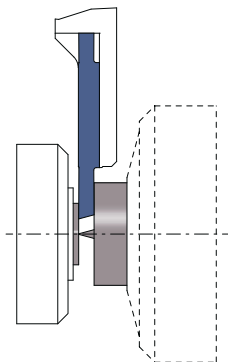

L (R)			Art. N°
A x B	L	R	
12 x 12	130	30	250RC-12
16 x 16	130	40	250RC-16

Utiliser des plaquettes type 251R
WSP Typ 251R verwenden
Use inserts type 251R



Chaque support est livré avec vis et clé.
Jeder Halter wird mit Spannschraube(n) und Schlüssel geliefert.
Screw(s) and key are included with each tool holder.

Porte-outils avec arrosage intégré
 Halter mit integrierter Kühlmittelzufuhr
 Holders with integrated coolant supply

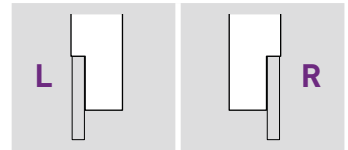
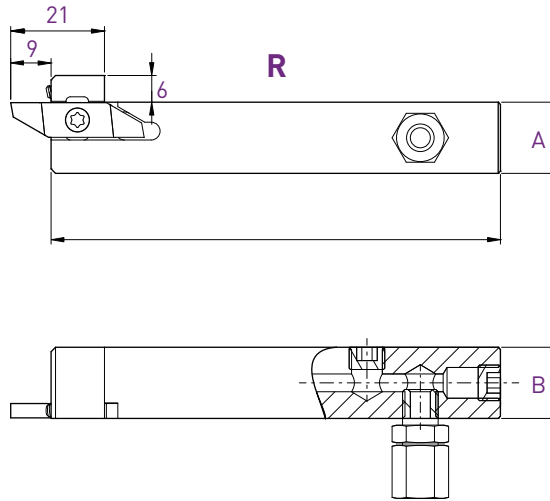
250-JET / 260-JET



A x B	L	Art. N°	Art. N°
10 x 12	100	250-1012-JET	260-1012-JET
12 x 12	100	250-12-JET	260-12-JET
16 x 16	100	250-16-JET	260-16-JET
20 x 20	100	250-20-JET	260-20-JET

Pièces de rechange Ersatzteile Spare parts			Buse Düse Nozzle 
	Art. N°	Art. N°	Art. N°
250-JET / 260-JET	J-M8X1-D6	JB-M8X1	JJ-M3X6-D1.5

Chaque support est livré avec vis et clé.
 Jeder Halter wird mit Spannschraube(n) und Schlüssel geliefert.
 Screw(s) and key are included with each tool holder.

Porte-outils

Halter

Holder

260/250F

L/R

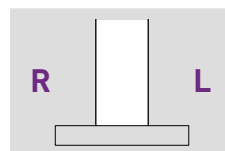
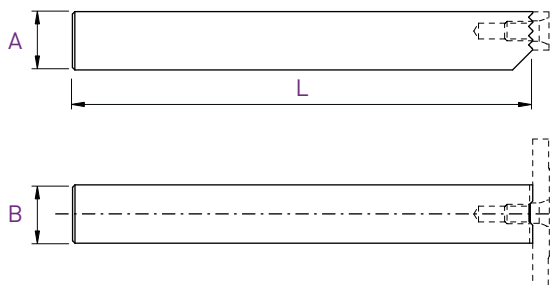

A x B	L	Art. N°
10 x 12	120	260/250F-1012
12 x 12	120	260/250F-1212

Porte-outils

Halter

Holder

260/250-D

L/R

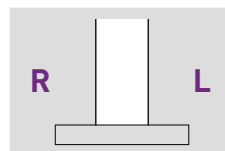
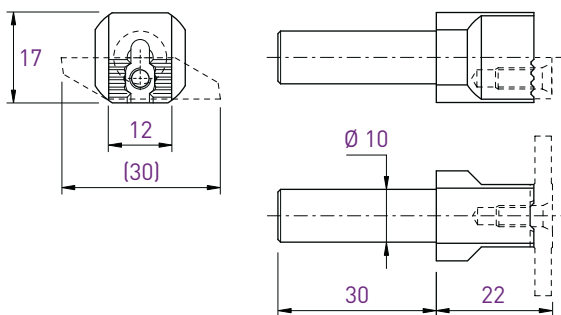

Art. N°
260/250-D10

Chaque support est livré avec vis et clé.
 Jeder Halter wird mit Spannschraube(n) und Schlüssel geliefert.
 Screw(s) and key are included with each tool holder.

ECO-LINE

Tronçonnage
Abstechen
Parting off

251 / 261

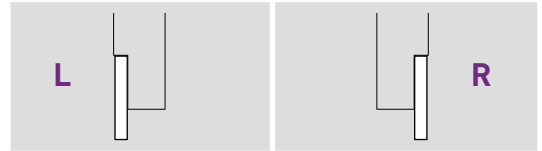
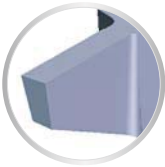
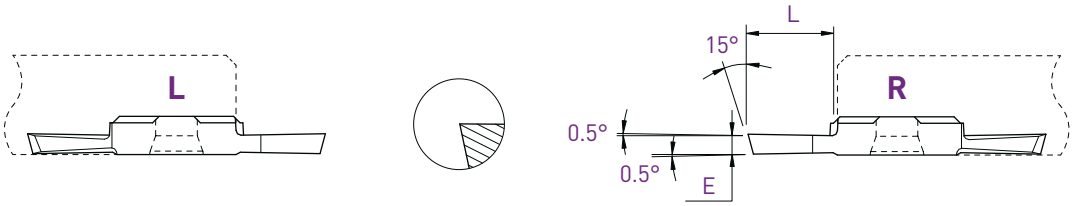

E	L	Art. N°	AP302	AP202	Z	Art. N°	AP302	AP202	Z
0.8	4	251-0.8	■	□	■	261-0.8	■	□	■
1.0	5	251-1.0	■	□	■	261-1.0	■	□	■
1.2	5	251-1.2	■	□	■	261-1.2	■	□	■
1.5	7	251-1.5	■	□	■	261-1.5	■	□	■
2.0	8.5	251-2.0	■	□	■	261-2.0	■	□	■
2.5	8.5	251-2.5	■	□	■	261-2.5	■	□	■

Tronçonnage
Abstechen
Parting off

Coupe déportée
Versetztes Schneiden
Cut off line

261L / 251R

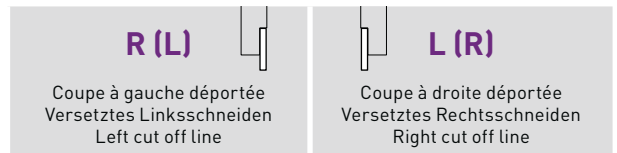
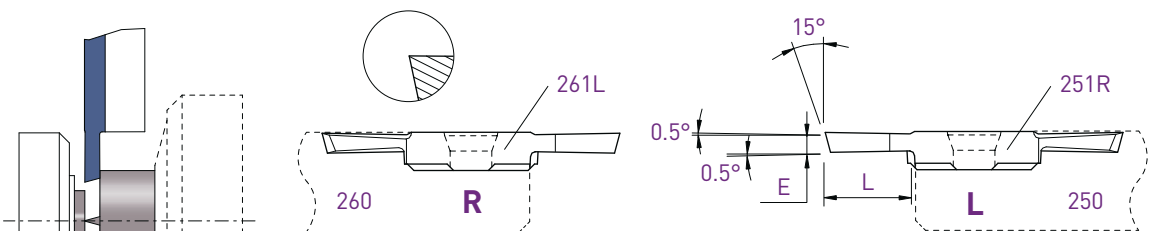

E	L	Art. N°	AP302	AP202	Z	Art. N°	AP302	AP202	Z
1.0	5	-				251R-1.0	■	□	■
1.5	7	-				251R-1.5	■	□	■
2.0	8.5	261L-2.0	■	□	■	251R-2.0	■	□	■

Tronçonnage

Abstechen

Parting off

251XF / 261XF

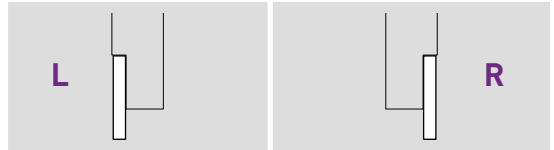
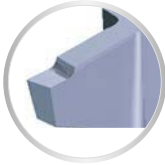
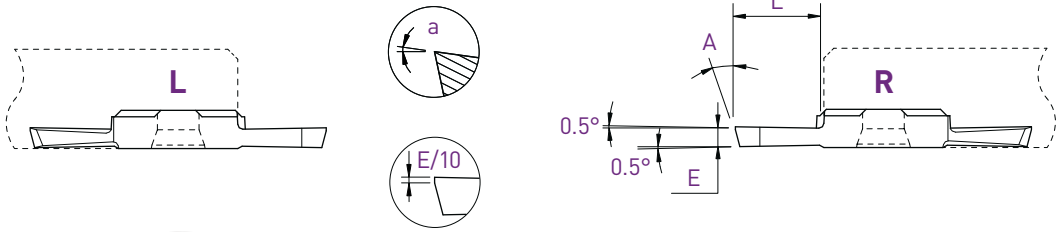

a	E	L	A	Art. N°	AP302	AP202	Z	Art. N°	AP302	AP202	Z
4°	1.0	4	15°	-				261XF-1.0	■	■	NEW
6°	1.0	4	8°	-				261XF6°-1.0-8°	■	■	NEW
4°	1.5	7	15°	251XF-1.5	■	□	■	261XF-1.5	■	□	■
4°	2.0	8.5	15°	251XF-2.0	■	□	■	261XF-2.0	■	□	■

Tronçonnage

Abstechen

Parting off

Coupe déportée

Versetztes Schneiden

Cut off line

251RXF

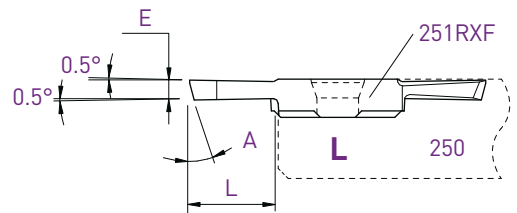
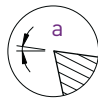
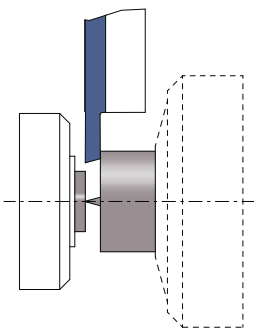

L (R)

Coupe à droite déportée
Versetztes Rechtsschneiden
Right cut off line

a	E	L	A	Art. N°	AP302	AP202	Z
6°	1.0	4	8°	251RXF6°-1.0-8°	■	■	NEW
4°	1.5	7	15°	251RXF-1.5	■	□	■
4°	2.0	8.5	15°	251RXF-2.0	■	□	■

■ = disponible / verfügbar / available

□ = selon disponibilité du stock / jenach Lagerverfügbarkeit / depending on stock availability

ECO-LINE

Tournage avant
Vorwärts drehen
Front turning

252 / 262

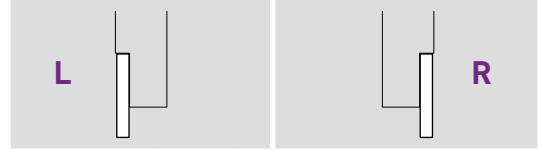

A	Art. N°	AP302	AP202	Z	Art. N°	AP302	AP202	Z
0°	252	■	□	■	262	■	□	■
2°	252-2°	■	□	■	262-2°	■	□	■

Tournage avant
Vorwärts drehen
Front turning

252X / 262X

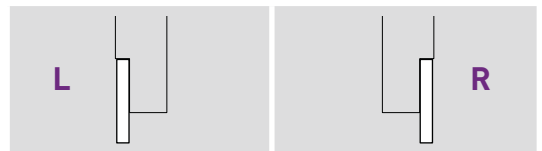
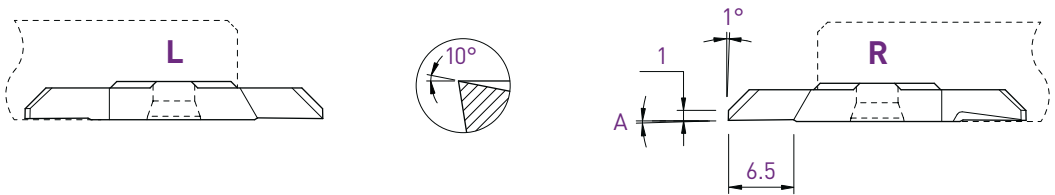

A	Art. N°	AP302	AP202	Z	Art. N°	AP302	AP202	Z
0°	252X	■	□	■	262X	■	□	■
2°	252X-2°	■	□	■	262X-2°	■	□	■

Tournage avant
Vorwärts drehen
Front turning

252S / 262S

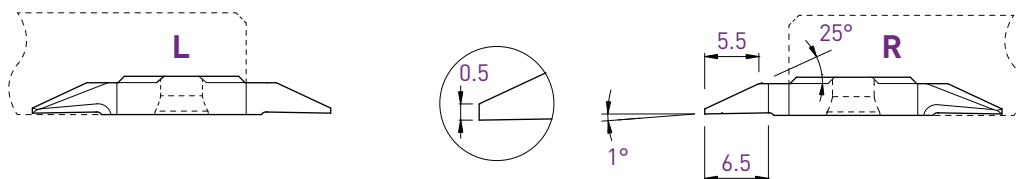

L				R			
Art. N°	AP302	AP202	Z	Art. N°	AP302	AP202	Z
252S05	■	□	■	262S05	■	□	■

Tournage arrière
Rückwärts drehen
Back turning

253S / 263S

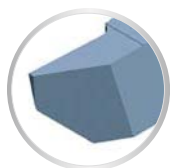
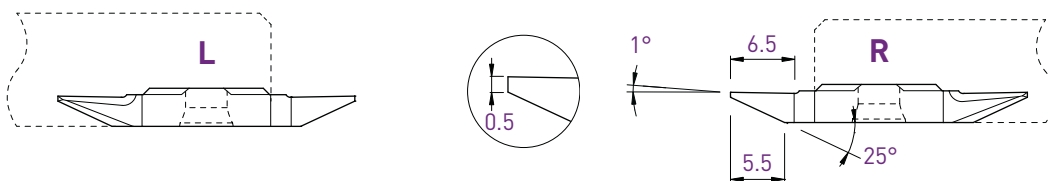

L				R			
Art. N°	AP302	AP202	Z	Art. N°	AP302	AP202	Z
253S05	■	□	■	263S05	■	□	■

ECO-LINE

Tournage arrière
Rückwärts drehen
Back turning

253 / 263

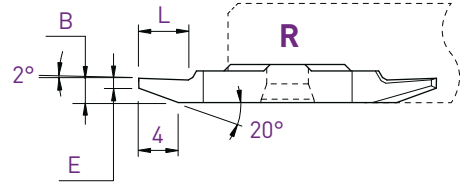
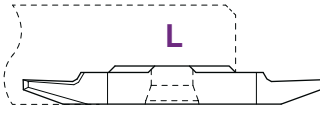

B	E	L	Art. N°	AP302	AP202	Z	Art. N°	AP302	AP202	Z
2.0	0.5	4	253-0.5	■	□	■	263-0.5	■	□	■
2.5	1.0	5	253-1.0	■	□	■	263-1.0	■	□	■

Tournage arrière
Rückwärts drehen
Back turning

253X / 263X

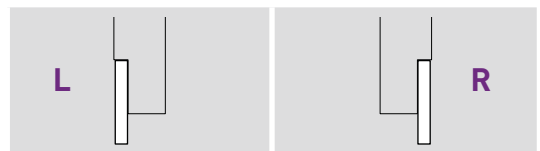
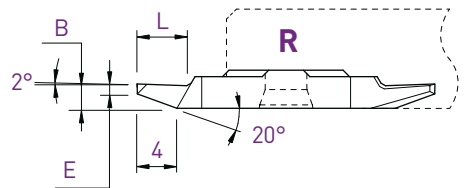
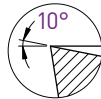
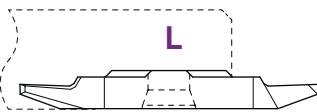

B	E	L	Art. N°	AP302	AP202	Z	Art. N°	AP302	AP202	Z
2.0	0.5	5	253X-0.5	■	□	■	263X-0.5	■	□	■
2.5	1.0	5	253X-1.0	■	□	■	263X-1.0	■	□	■

Tournage arrière
Rückwärts drehen
Back turning

253VX-8° / 263VX-8°

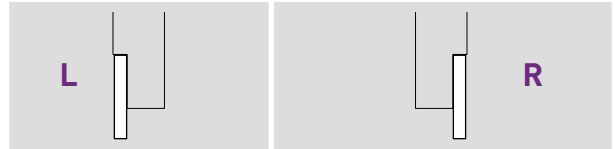
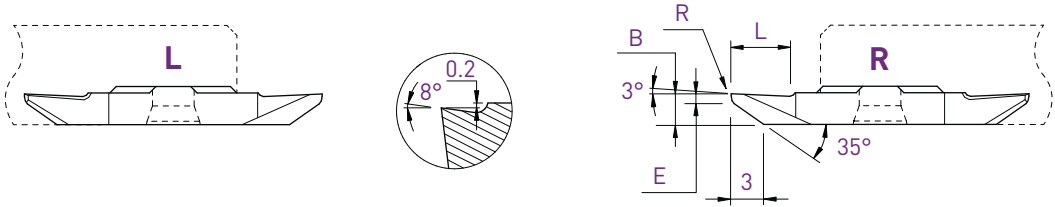

B	E	L	R	Art. N°	AP302	AP202	Z	Art. N°	AP302	AP202	Z	AH302	HN
3.1	1.0	6	0	253VX-8°	■	□	■	263VX-8°	■	□	■		
3.1	1.0	6	0.08	-				263VX-8°-R08	■	□	■	■	■
3.1	1.0	6	0.20	-				263VX-8°-R20	■	□	■	■	■

Tournage arrière
Rückwärts drehen
Back turning

253VX-805 / 263VX-805

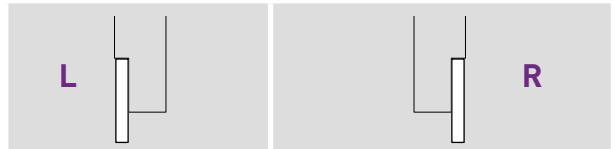
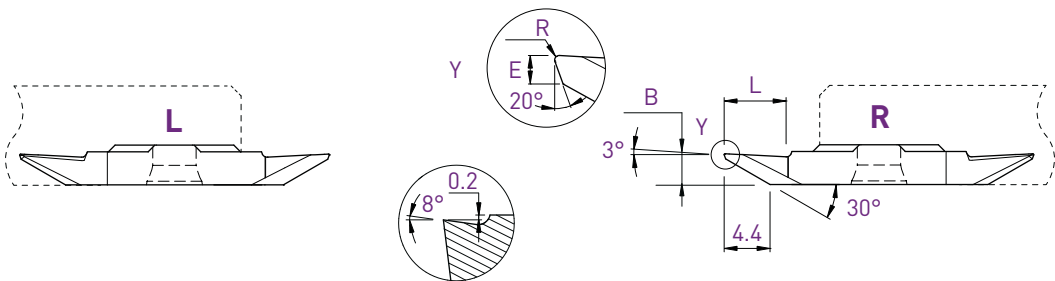

B	E	L	R	Art. N°	AP302	AP202	Z	Art. N°	AP302	AP202	Z	AH302	HN
3.0	0.5	6	0.08	253VX-805-R08	■	□	■	263VX-805-R08	■	□	■	■	■

■ = disponible / verfügbar / available
□ = selon disponibilité du stock / jenach Lagerverfügbarkeit / depending on stock availability

ECO-LINE

Fonçage-tournage
 Einstechen und drehen
 Grooving and turning

254 / 264

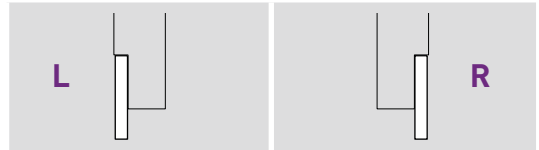
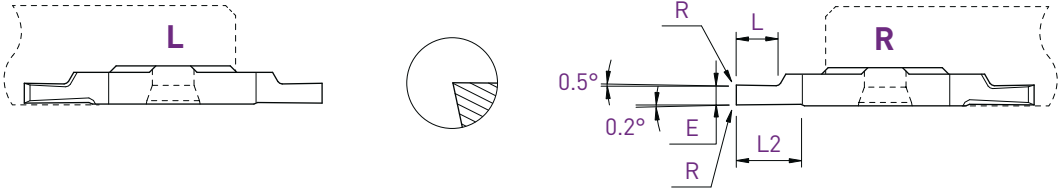

E	L	L2	R	Art. N°	AP302	AP202	Z	Art. N°	AP302	AP202	Z
0.8	2	4	0	254-0.8	■	□	■	264-0.8	■	□	■
1.0	2.5	4	0	254-1.0	■	□	■	264-1.0	■	□	■
1.2	3	4	0	254-1.2	■	□	■	264-1.2	■	□	■
1.5	3	4	0	254-1.5	■	□	■	264-1.5	■	□	■
1.8	4	6.5	0	-				264-1.8	■	□	■
2.0	4	6.5	0	254-2.0	■	□	■	264-2.0	■	□	■
2.5	6	6.5	0	254-2.5	■	□	■	264-2.5	■	□	■
3.0	6.5	6.5	0	254-3.0	■	□	■	264-3.0	■	□	■

Fonçage-tournage

Einstecken und drehen

Grooving and turning

254X / 264X

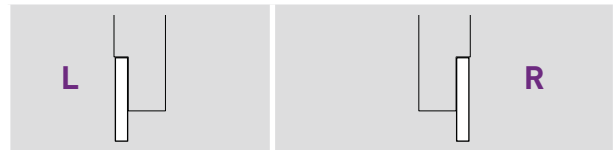
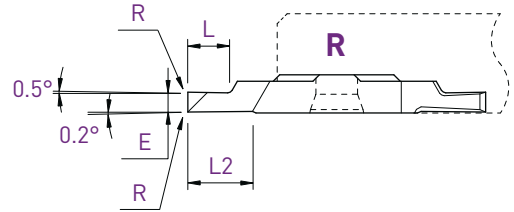
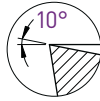
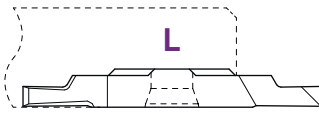

E	L	L2	R	Art. N°	AP302	AP202	Z	Art. N°	AP302	AP202	Z	AH302	HN
0.8	2	4	0	254X-0.8	■	□	■	264X-0.8	■	□	■		
1.0	2.5	4	0	254X-1.0	■	□	■	264X-1.0	■	□	■		
1.0	2.5	4	0.08	-				264X-1.0-R08	■	□	■	■	■
1.2	3	4	0	254X-1.2	■	□	■	264X-1.2	■	□	■		
1.5	3	4	0	254X-1.5	■	□	■	264X-1.5	■	□	■		
1.5	3	4	0.08	-				264X-1.5-R08	■	□	■	■	■
1.5	3	4	0.20	-				264X-1.5-R20	■	□	■	■	■
2.0	4	6.5	0	254X-2.0	■	□	■	264X-2.0	■	□	■		
2.0	4	6.5	0.08	-				264X-2.0-R08	■	□	■	■	■
2.0	4	6.5	0.20	-				264X-2.0-R20	■	□	■	■	■
2.5	6	6.5	0	254X-2.5	■	□	■	264X-2.5	■	□	■		
2.5	6.5	6.5	0.08	-				264X-2.5-R08	■	□	■	■	■
2.5	6.5	6.5	0.20	-				264X-2.5-R20	■	□	■	■	■
3.0	6.5	6.5	0	254X-3.0	■	□	■	264X-3.0	■	□	■		
3.0	6.5	6.5	0.08	-				264X-3.0-R08	■	□	■	■	■
3.0	6.5	6.5	0.20	-				264X-3.0-R20	■	□	■	■	■

Filetage
Gewinde drehen
Threading

Partial profile 60°

256-60 / 266-60

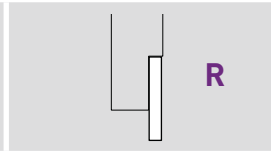
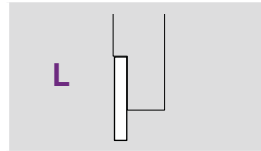
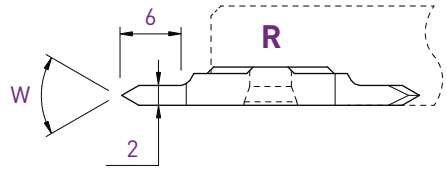
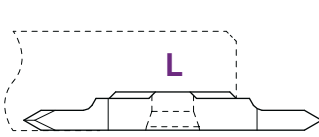

W	R	a	Art. N°	AP302	AP202	Z	Art. N°	AP302	AP202	Z
60°	0	0°	256-60-2.0	■	□	■	266-60-2.0	■	□	■
60°	0.06	3°	256-AG60°	■	□	■	266-AG60°	■	□	■

Filetage
Gewinde drehen
Threading

Partial profile 55°

256-55 / 266-55

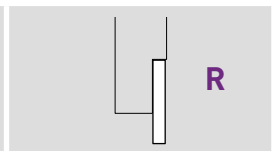
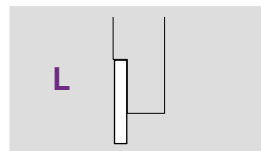
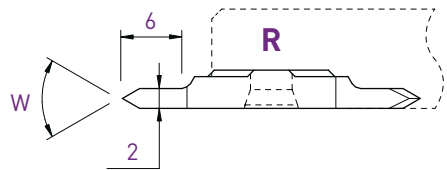
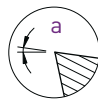
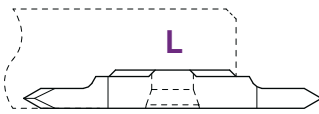

W	R	a	Art. N°	AP302	AP202	Z	Art. N°	AP302	AP202	Z
55°	0	0°	256-55-2.0	■	□	■	266-55-2.0	■	□	■
55°	0.06	3°	256-AG55°	■	□	■	266-AG55°	■	□	■

Plaquettes ébauches

WSP-Rohlinge

Blank inserts

251-E / 261-E

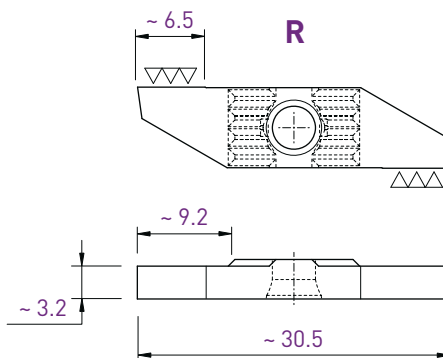
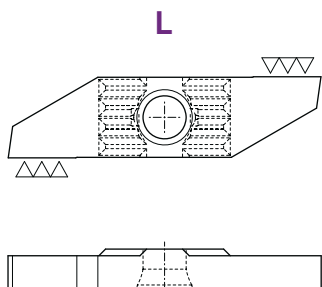

L					R						
Art. N°	AP302	AP202	N	AH302	HN	Art. N°	AP302	AP202	N	AH302	HN
251-E	■	□	■	■	■	261-E	■	□	■	■	■

APPLITEC

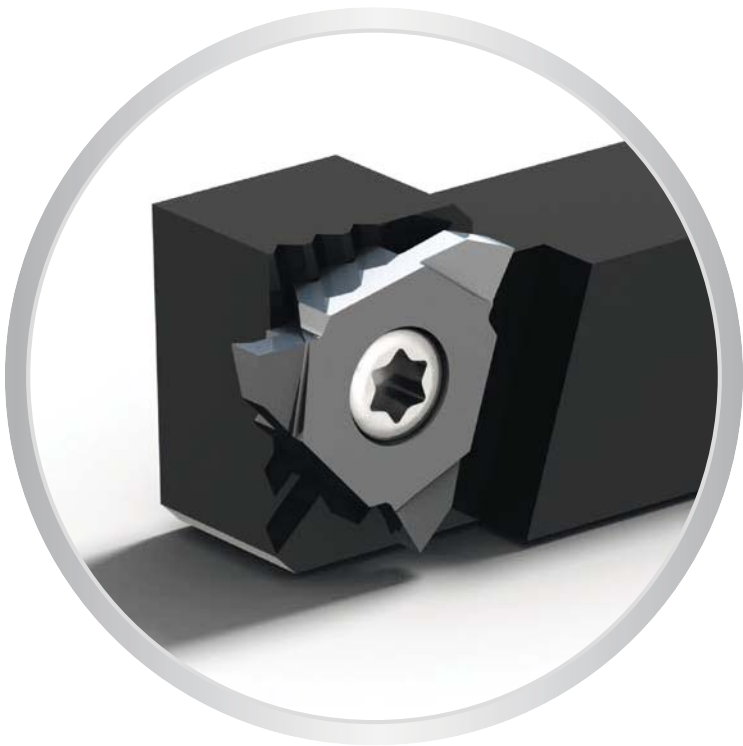

Nuances
Sorten
Grades

> 5.02

Conseils d'utilisation - Accessoires
Anwendungsempfehlungen - Zubehör
Application recommendations - Accessories



> 5.03

Porte-outils
Halter
Holders

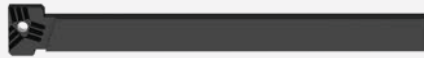

> 5.04

GX

Gorge de précision
Präzisionseinstechen
High precision grooving

DIN6799
& DIN471



> 5.05

FT

Tournage finition
Schlicht drehen
Fine turning



> 5.06

GT

Fonçage-tournage
Einstechen und drehen
Grooving and turning



> 5.07

GTX

Fonçage-tournage avec coupe positive
Einstechen und drehen mit positivem Spanwinkel
Grooving and turning with positive cut



> 5.08

EP

Plaquettes ébauches
WSP-Rohlinge
Blank inserts



> 5.09

Rigid clamping system with the famous Applitec teeth clamping

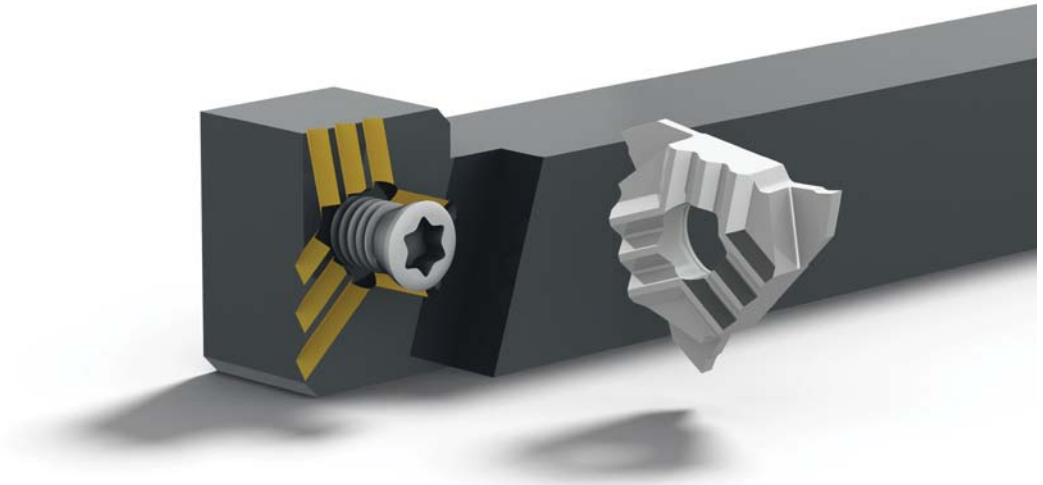

Nuances micro-grain à dureté élevée

Verschleissfeste Feinkornsorten

Wear resistant micro-grain grades

HTA

μK10 + revêtement PVD
μK10 + PVD Beschichtung
μK10 + PVD coating

- nuance très résistante à l'usure
- pour l'usinage en finition dans des conditions favorables des aciers, aciers inoxydables et alliages de titane

- sehr verschleissfeste Sorte
- für die Feinbearbeitung von Stahl, rostfreiem Stahl und Titanlegierungen bei guten Bearbeitungsbedingungen

- very wear resistant grade
- for light machining of steel, stainless steel and titanium alloys under favourable machining conditions

HN (μK10)

non revêtu
unbeschichtet
uncoated

- nuance micro-grain très résistante à l'usure
- recommandé pour l'usinage du laiton, de l'aluminium et du titane faiblement allié

- sehr verschleissfeste Feinkornsorte
- für die Bearbeitung von Messing und niedrig legiertem Aluminium und Titan empfehlenswert

- very wear resistant micro-grain grade
- suitable for the machining of brass and low alloyed aluminium and titanium

Paramètres de coupe indicatifs

Empfohlene Schnittwerte

Standard machining data

Matière Werkstoff Material	Tournage Drehen Turning		Foncer Einstechen Grooving	
	VC (m/min)	F (mm/U)	VC (m/min)	F (mm/U)
Acier de décolletage Automatenstahl Free-cutting steel	P 120 - 200	0.01 - 0.20	80 - 150	0.01 - 0.15
Acier Stahl Steel < 600 N/mm ²	P 80 - 160	0.01 - 0.18	70 - 120	0.01 - 0.12
Acier Stahl Steel < 800 N/mm ²	P 60 - 120	0.01 - 0.15	60 - 100	0.01 - 0.10
Acier Stahl Steel > 800 N/mm ²	P 50 - 100	0.01 - 0.12	40 - 80	0.01 - 0.08
Acier inoxydable Rostfreistahl Stainless steel	M 60 - 120	0.01 - 0.15	60 - 100	0.01 - 0.08
Aluminium	N 180 - 800	0.01 - 0.30	150 - 300	0.01 - 0.20
Cuivre, laiton, bronze Kupfer, Messing, Bronze Copper, brass, bronze	N 100 - 500	0.01 - 0.30	100 - 300	0.01 - 0.20
Titane Titan Titanium	S 30 - 70	0.01 - 0.12	30 - 50	0.01 - 0.06

Accessoires

Zubehöre

Accessories

Porte-outils Halter Holders			Option Art. N°
T216-H...	V-M4X9-T15	C-T15	SET-NM-TX15

Recommandation de serrage
Drehmoment Empfehlung
Clamping recommendation

3.0 Nm



SET-NM-TX15

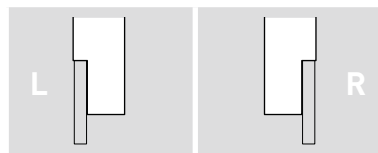
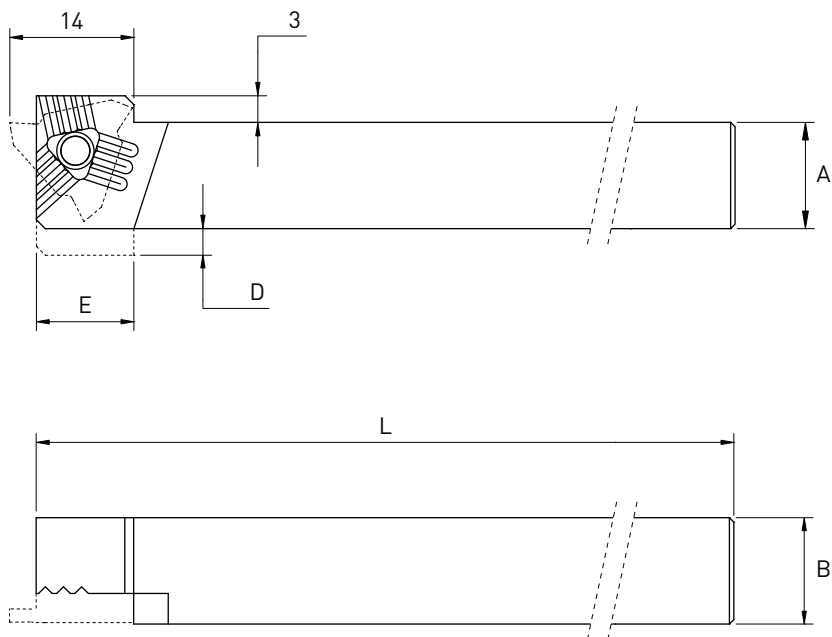

Chaque support est livré avec vis et clé.
 Jeder Halter wird mit Spannschraube(n)
 und Schlüssel geliefert.
 Screw(s) and key are included with each
 tool holder.

A	B	D	E	L	Art. N°	Art. N°
8	10	4	11	115	T216-H0810L	T216-H0810R
10	10	2	8	130	T216-H1010L	T216-H1010R
12	12	-	-	130	T216-H1212L	T216-H1212R
12	12	-	-	90	T216-H1212L-90	T216-H1212R-90
16	16	-	-	120	T216-H1616L	T216-H1616R
20	20	-	-	130	T216-H2020L	T216-H2020R

Plaquettes de gorge pour circlips

Einstechwendeplatte für Seegerring

Grooving inserts for retaining ring

GX

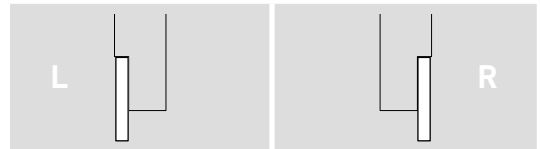
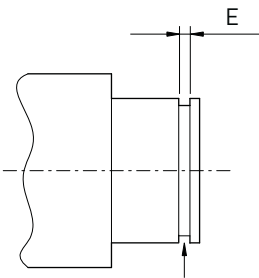
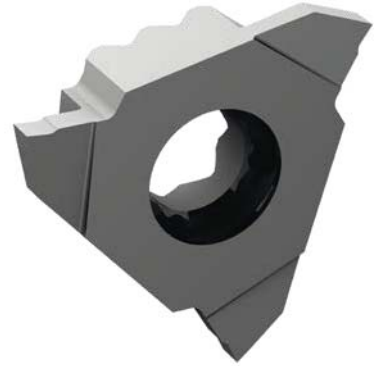
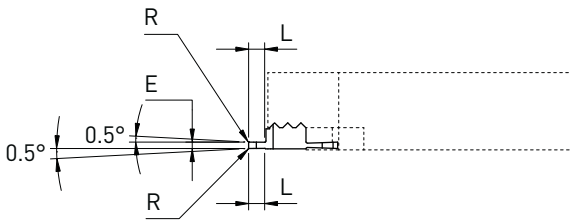
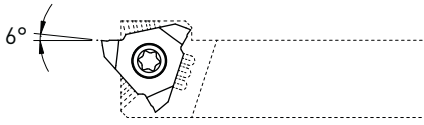

Selon DIN6799 et DIN471
Gemäss DIN6799 und DIN471
According to DIN6799 and DIN471



E ±0,01	L	R	L		R	
			Art. N°	HTA HN	Art. N°	HTA HN
0.26	0.8	0.03	T216L-GX026	■ ■	T216R-GX026	■ ■
0.36	0.8	0.03	T216L-GX036	■ ■	T216R-GX036	■ ■
0.46	0.8	0.03	T216L-GX046	■ ■	T216R-GX046	■ ■
0.50	1.5	0.03	T216L-GX050	■ ■	T216R-GX050	■ ■
0.57	1.5	0.03	T216L-GX057	■ ■	T216R-GX057	■ ■
0.67	1.5	0.03	T216L-GX067	■ ■	T216R-GX067	■ ■
0.77	2.0	0.03	T216L-GX077	■ ■	T216R-GX077	■ ■
0.87	2.0	0.03	T216L-GX087	■ ■	T216R-GX087	■ ■
0.97	2.5	0.03	T216L-GX097	■ ■	T216R-GX097	■ ■
1.00	2.5	0.03	T216L-GX100	■ ■	T216R-GX100	■ ■
1.10	2.5	0.03	T216L-GX110	■ ■	T216R-GX110	■ ■
1.20	2.5	0.03	T216L-GX120	■ ■	T216R-GX120	■ ■
1.30	2.5	0.03	T216L-GX130	■ ■	T216R-GX130	■ ■
1.50	2.5	0.03	T216L-GX150	■ ■	T216R-GX150	■ ■
1.60	2.5	0.03	T216L-GX160	■ ■	T216R-GX160	■ ■
1.85	2.5	0.03	T216L-GX185	■ ■	T216R-GX185	■ ■
2.00	2.5	0.03	T216L-GX200	■ ■	T216R-GX200	■ ■
2.50	2.5	0.03	T216L-GX250	■ ■	T216R-GX250	■ ■

TRIO-LINE

Tournage avant
Vorwärts drehen
Front turning

FT

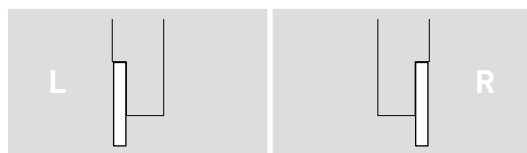
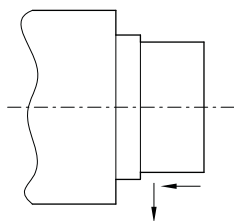
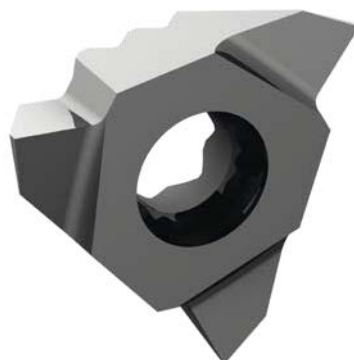
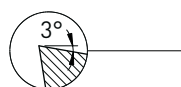
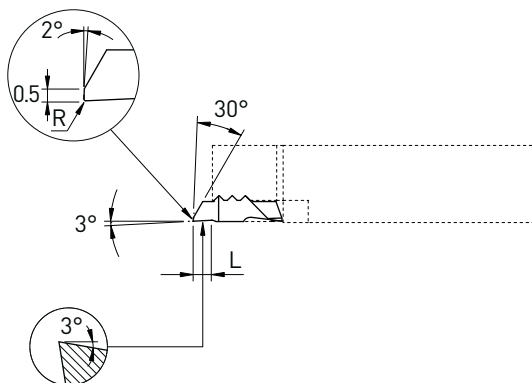
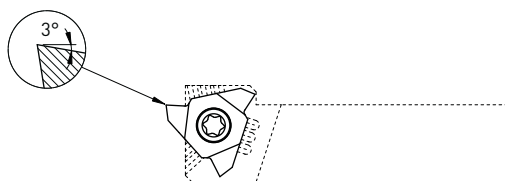

		L		R	
L	R	Art. N°	HTA HN	Art. N°	HTA HN
3.0	0.03	T216L-FT	■ ■	T216R-FT	■ ■
3.0	0.08	T216L-FT-R08	■ ■	T216R-FT-R08	■ ■

Fonçage-tournage

Einstecken und drehen

Grooving and turning

GT

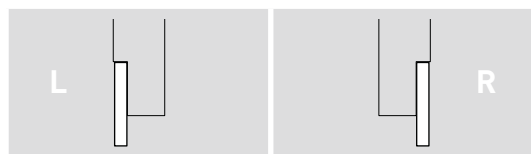
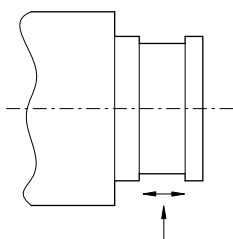
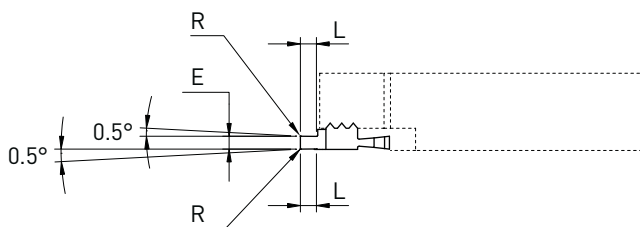
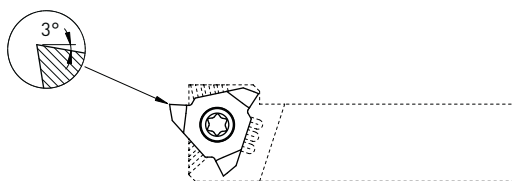

E	L	R	L		R	
			Art. N°	HTA HN	Art. N°	HTA HN
0.5	1.5	0.03	T216L-GT050	■ ■	T216R-GT050	■ ■
1.0	2.5	0.03	T216L-GT100	■ ■	T216R-GT100	■ ■
1.0	2.5	0.08	T216L-GT100-R08	■ ■	T216R-GT100-R08	■ ■
1.5	2.5	0.03	T216L-GT150	■ ■	T216R-GT150	■ ■
1.5	2.5	0.08	T216L-GT150-R08	■ ■	T216R-GT150-R08	■ ■
1.5	2.5	0.15	T216L-GT150-R15	■ ■	T216R-GT150-R15	■ ■
2.0	2.5	0.03	T216L-GT200	■ ■	T216R-GT200	■ ■
2.0	2.5	0.08	T216L-GT200-R08	■ ■	T216R-GT200-R08	■ ■
2.0	2.5	0.15	T216L-GT200-R15	■ ■	T216R-GT200-R15	■ ■
2.5	2.5	0.15	T216L-GT250-R15	■ ■	T216R-GT250-R15	■ ■

TRIO-LINE

Fonçage-tournage
Einstecken und drehen
Grooving and turning

GTX

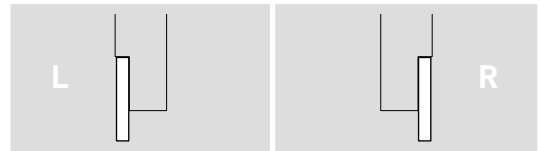
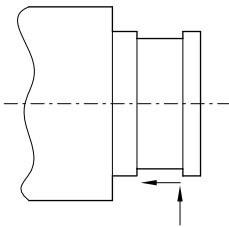
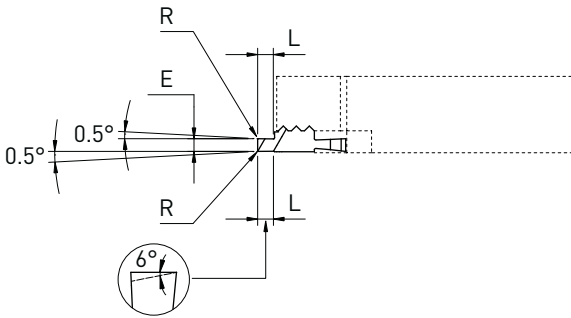
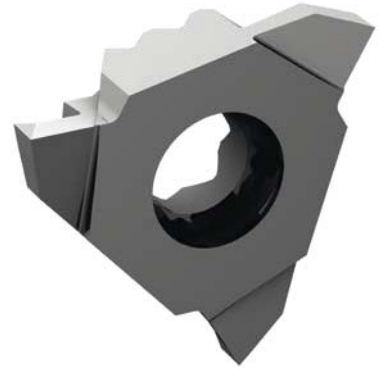
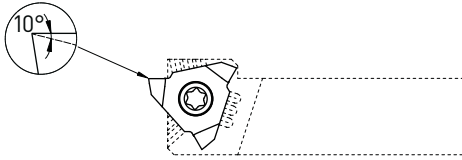

E	L	R	Art. N°	HTA		Art. N°	HN	
				HTA	HN		HTA	HN
1.0	2.5	0.03	T216L-GTX100	■	■	T216R-GTX100	■	■
1.0	2.5	0.08	T216L-GTX100-R08	■	■	T216R-GTX100-R08	■	■
1.5	2.5	0.03	T216L-GTX150	■	■	T216R-GTX150	■	■
1.5	2.5	0.08	T216L-GTX150-R08	■	■	T216R-GTX150-R08	■	■
1.5	2.5	0.15	T216L-GTX150-R15	■	■	T216R-GTX150-R15	■	■
2.0	2.5	0.03	T216L-GTX200	■	■	T216R-GTX200	■	■
2.0	2.5	0.08	T216L-GTX200-R08	■	■	T216R-GTX200-R08	■	■
2.0	2.5	0.15	T216L-GTX200-R15	■	■	T216R-GTX200-R15	■	■
2.5	2.5	0.15	T216L-GTX250-R15	■	■	T216R-GTX250-R15	■	■

- Plaquettes ébauches
- WSP-Rohlinge
- Blank inserts

EP

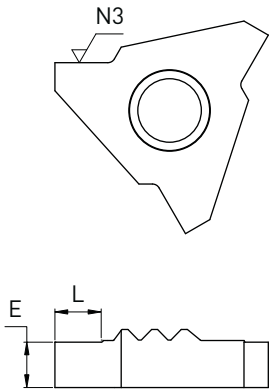

		L		R	
E	L	Art. N°	HTA HN	Art. N°	HTA HN
~3	3	T216L-EP	■	T216R-EP	■



300 Series

3 contact points

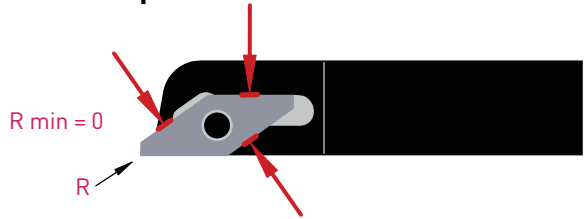

rigid clamping system

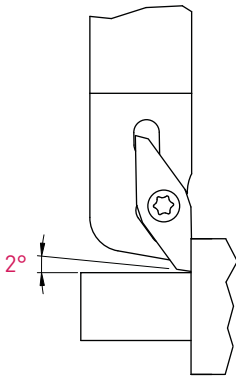

“wiper effect”

Pour un meilleur état de surface
Für eine bessere Oberflächengüte
For a better surface finish



Conseils d'utilisation et paramètres de coupe indicatifs
 Anwendungsempfehlungen und empfohlene Schnittwerte
 Application recommendations and standard machining data

> 6.02

Tournage avant
 Vorwärts drehen
 Front turning

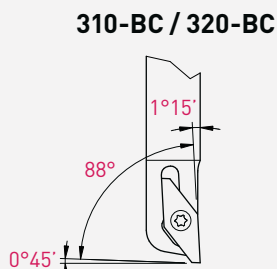
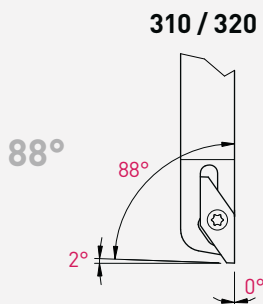

Tournage avant
 Vorwärts drehen
 Front turning

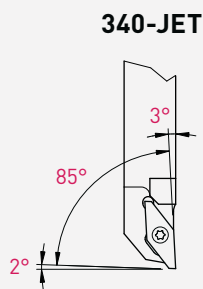
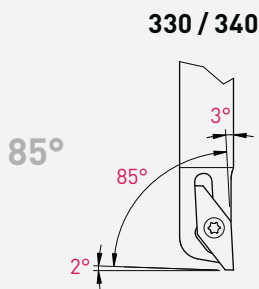







TURN-LINE

Conseils d'utilisation

Anwendungsempfehlungen

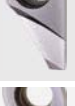
Application recommendations

Géométries de coupe Spanformgeometrien Cutting geometry		P		M		N		S		★							
		Acier de décolletage Automatenstahl Free-cutting steel		Acier Stahl Steel		Acier inoxydable Rostfreistahl Stainless steel		Aluminium		Laiton, bronze Messing, Bronze Brass, bronze		Cuivre Kupfer Copper		Titane Titane Titanium		1 ^{er} choix 1. Wahl 1 st choice	
		★		★		★		★		★		★		★		Recommandé Empfohlen Recommended	
		☆		☆		☆		☆		☆		☆		☆		Pour pièces fragiles de très petits diamètres Für empfindliche und sehr kleine Werkstücke For fragile and very small work pieces	
	3_7	★	★	★	★	★	★	★	★	★	★	★	★	★	★	★	Géométrie universelle, très bonne maîtrise du copeau Allgemeine Geometrie, sehr gute Spankontrolle All-round insert with efficient chip control
	3_7-EN	☆	★	☆	☆	☆	☆	☆	☆	☆	☆	☆	☆	☆	☆	☆	Arête renforcée (augmente l'effort de coupe) Verstärkte Schneidkante (Schneidkraftehöhung) Reinforced cutting edge (increases cutting force) f min: 0.02 mm/U
	3_8	☑	☑	☑	☑	☑	☑	☑	☑	☑	☑	☑	☑	☑	☑	☑	Géométrie plate classique Standard flache Geometrie Standard flat geometry
	3_8VS	☆	☆	☆	☆	☆	☆	☆	☆	☆	☆	☆	☆	☆	☆	☆	Brise-copeau pour usinage léger en finition Spanbrecher für leichte Schlichtbearbeitung Chip-breaker for light finishing operation
	3_8VX	★	★	★	★	★	★	★	★	★	★	★	★	★	★	★	Très bonne maîtrise du copeau Sehr gute Spankontrolle Very efficient chip control
	3_8X	★	★	★	★	★	★	★	★	★	★	★	★	★	★	★	Coupe positive traditionnelle Standard positive Geometrie Standard positive geometry
	3_9	☆	☆	☆	☆	☆	☆	☆	☆	☆	☆	☆	☆	☆	☆	☆	Témoin plat sur la coupe pour réduire les vibrations Vibrationsreduzierung durch einer Flachfase und der Schneidkante Vibration reduction through flat ended cutting edge

Nuances micro-grain à dureté élevée

Verschleissfeste Feinkornsorten

Wear resistant micro-grain grades

<p>P M N S</p> <h2>TiAlN</h2> <p>μK20 + revêtement PVD μK20 + PVD Beschichtung μK20 + PVD coating</p>	<p>P M N <input type="checkbox"/>S</p> <h2>TiN</h2> <p>μK20 + revêtement PVD μK20 + PVD Beschichtung μK20 + PVD coating</p>	<p>P M <input type="checkbox"/>N S</p> <h2>TiAlX</h2> <p>μK20 + revêtement PVD μK20 + PVD Beschichtung μK20 + PVD coating</p>	<p>P <input type="checkbox"/>M N S</p> <h2>N (μK20)</h2> <p>non revêtu unbeschichtet uncoated</p>
<ul style="list-style-type: none"> excellente nuance universelle 1^{er} choix pour l'usinage des aciers, aciers inoxydables et alliages de titane très bonne résistance à la température 	<ul style="list-style-type: none"> nuance pour l'usinage des matières peu résistantes qui créent des arêtes rapportées très faible coefficient de frottement à éviter pour l'usinage du titane 	<ul style="list-style-type: none"> nuance très résistante à l'usure et à la température, recommandée pour l'usinage des matières suivantes: Inox 304, 316L, 317L, 904, Phynox aciers alliés contenant: Chrome Nickel, Vanadium, Molybdène, ... 	<ul style="list-style-type: none"> supporte les coupes interrompues et autres conditions d'usinage défavorables
<ul style="list-style-type: none"> beste Universalsorte für die Bearbeitung von Stahl, rostfreiem Stahl und Titanlegierungen bestens geeignet sehr gute Warmfestigkeit 	<ul style="list-style-type: none"> Sorte für die Bearbeitung von weichen Werkstoffen mit Tendenz zur Bildung von Aufbauschneiden sehr geringer Reibwert für die Bearbeitung von Titan nicht geeignet 	<ul style="list-style-type: none"> sehr verschleissfeste und temperaturbeständige Sorte. Für folgende Materialien empfohlen: Inox 304, 316L, 317L, 904, Phynox legierter Stahl enthaltend: Chrom-Nickel, Vanadium, Molybdän, ... 	<ul style="list-style-type: none"> für unterbrochene Schnitte und andere ungünstige Bearbeitungsbedingungen geeignet
<ul style="list-style-type: none"> best universal grade first choice for steel, stainless steel and titanium alloys machining very good heat resistance 	<ul style="list-style-type: none"> grade for the machining of low resistance materials which causes edge build-up very low friction ratio not suitable for titanium machining 	<ul style="list-style-type: none"> very wear and high temperature resistant grade. Recommended for following material: Inox 304, 316L, 317L, 904, Phynox alloy steel containing: Chrome-nickel, Vanadium, Molybdenum, ... 	<ul style="list-style-type: none"> suitable for interrupted cut and other unfavourable machining conditions
<p>P M N S</p> <h2>HTA</h2> <p>μK10 + revêtement PVD μK10 + PVD Beschichtung μK10 + PVD coating</p>	<p>P M N <input type="checkbox"/>S</p> <h2>HTiN</h2> <p>μK10 + revêtement PVD μK10 + PVD Beschichtung μK10 + PVD coating</p>	<p>P M <input type="checkbox"/>N S</p> <h2>HTAX</h2> <p>μK10 + revêtement PVD μK10 + PVD Beschichtung μK10 + PVD coating</p>	<p>P <input type="checkbox"/>M N S</p> <h2>HN (μK10)</h2> <p>non revêtu unbeschichtet uncoated</p>
<ul style="list-style-type: none"> nuance très résistante à l'usure pour l'usinage en finition dans des conditions favorables des aciers, aciers inoxydables et alliages de titane 	<ul style="list-style-type: none"> nuance pour l'usinage en finition des matières peu résistantes qui créent des arêtes rapportées très faible coefficient de frottement à éviter pour l'usinage du titane 	<ul style="list-style-type: none"> nuance très résistante à l'usure et à la température, pour l'usinage en finition avec faible avance de petites pièces. Recommandée pour l'usinage des matières suivantes: Inox 304, 316L, 317L, 904, Phynox aciers alliés contenant: Chrome Nickel, Vanadium, Molybdène, ... 	<ul style="list-style-type: none"> nuance micro-grain très résistante à l'usure recommandé pour l'usinage du titane faiblement allié déconseillé en cas de coupe interrompue et autres conditions d'usinage défavorables
<ul style="list-style-type: none"> sehr verschleissfeste Sorte für die Feinbearbeitung von Stahl, rostfreiem Stahl und Titanlegierungen bei guten Bearbeitungsbedingungen 	<ul style="list-style-type: none"> Sorte für die Feinbearbeitung von weichen Werkstoffen mit Tendenz zur Bildung von Aufbauschneiden sehr geringer Reibwert für die Bearbeitung von Titan nicht geeignet 	<ul style="list-style-type: none"> sehr verschleissfeste und temperaturbeständige Sorte, für Feinbearbeitung von kleinen Teilen mit geringer Vorschub. Für folgende Materialien empfohlen: Inox 304, 316L, 317L, 904, Phynox legierter Stahl enthaltend: Chrom-Nickel, Vanadium, Molybdän, ... 	<ul style="list-style-type: none"> verschleissfeste Feinkornsorte für die Bearbeitung von niedrig legiertem Titan empfehlenswert für unterbrochene Schnitte und andere ungünstige Bearbeitungsbedingungen nicht geeignet
<ul style="list-style-type: none"> very wear resistant grade for light machining of steel, stainless steel and titanium alloys under favourable machining conditions 	<ul style="list-style-type: none"> grade for light machining of low resistance materials which causes edge build-up very low friction ratio not suitable for titanium machining 	<ul style="list-style-type: none"> very wear and high temperature resistant grade, for light machining of small parts with low cutting feed. Recommended for following material: Inox 304, 316L, 317L, 904, Phynox alloy steel containing: Chrome-nickel, Vanadium, Molybdenum, ... 	<ul style="list-style-type: none"> wear resistant micro-grain grade suitable for the machining of low alloyed titanium not suitable for interrupted cut and other unfavourable machining conditions

TURN-LINE

Paramètres de coupe indicatifs

Empfohlene Schnittwerte

Standard machining data

Matière Werkstoff Material		Tournage Drehen Turning		
		VC	Prof. de passe Schnitttiefe Depth of cut	Avance Vorschub Feed
		(m/min)	(mm)	(mm/U)
Acier de décolletage Automatenstahl Free-cutting steel	P	120 - 200	0.05 - 1.0 1.0 - 4.0	0.01 - 0.15 0.05 - 0.25
Acier Stahl Steel	< 600 N/mm ² P	80 - 160	0.05 - 1.0 1.0 - 4.0	0.01 - 0.15 0.05 - 0.25
Acier Stahl Steel	< 800 N/mm ² P	60 - 120	0.05 - 1.0 1.0 - 4.0	0.01 - 0.10 0.05 - 0.20
Acier Stahl Steel	> 800 N/mm ² P	50 - 100	0.05 - 1.0 1.0 - 3.0	0.01 - 0.08 0.05 - 0.15
Acier inoxydable Rostfreistahl Stainless steel	M	60 - 120	0.05 - 1.0 1.0 - 3.0	0.01 - 0.08 0.05 - 0.15
Aluminium Si <12%	N	200 - 1000	0.05 - 1.0 1.0 - 4.0	0.01 - 0.20 0.05 - 0.40
Aluminium Si >12%	N	180 - 800	0.05 - 1.0 1.0 - 4.0	0.01 - 0.20 0.05 - 0.40
Cuivre, laiton, bronze Kupfer, Messing, Bronze Copper, brass, bronze	N	100 - 500	0.05 - 1.0 1.0 - 4.0	0.01 - 0.20 0.05 - 0.35
Titane Titan Titanium	S	30 - 70	0.05 - 1.0 1.0 - 4.0	0.01 - 0.08 0.05 - 0.15

Indications pour premier réglage

Hinweise für die erste Einrichtung

Indications for first setting

Ébauche Schruppen Roughing	Finition Schlichten Finishing
<ul style="list-style-type: none"> • vitesse de coupe moyenne • avance élevée 	<ul style="list-style-type: none"> • vitesse de coupe élevée • avance faible
<ul style="list-style-type: none"> • durchschnittliche Schnittgeschwindigkeit • hohe Schnittgeschwindigkeit 	<ul style="list-style-type: none"> • hohe Schnittgeschwindigkeit • niedriger Vorschub
<ul style="list-style-type: none"> • average cutting speed • high cutting speed 	<ul style="list-style-type: none"> • high cutting speed • low cutting feed

Remarques importantes
Wichtige Bemerkungen
Important remarks

- en raison des limites de la machine, il n'est souvent pas possible d'atteindre les vitesses de coupe préconisées
- les outils Applitec sont spécialement développés pour permettre de hautes performances, même dans des conditions de coupe défavorables
- des applications non préconisées dans le tableau ci-contre peuvent également s'avérer efficaces

- wegen begrenzter Maschinenleistung ist es oft nicht möglich, die vorgeschlagenen Schnittgeschwindigkeiten zu erreichen
- Applitec Werkzeuge sind besonders dazu entwickelt, um sogar bei ungünstigen Schnittdaten leistungsfähig zu sein
- die in der nebenstehender Tabelle nicht erwähnten Anwendungsfälle können sich auch effizient erweisen

- in many cases, it is impossible to reach the recommended cutting speed, due to the machine limits
- Applitec tools are especially designed to be efficient even in bad cutting conditions
- applications not mentioned in the opposite table can also be efficient

TURN-LINE

Porte-outils

Halter

Holder

88°

310 / 320

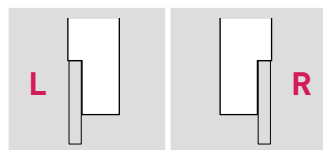
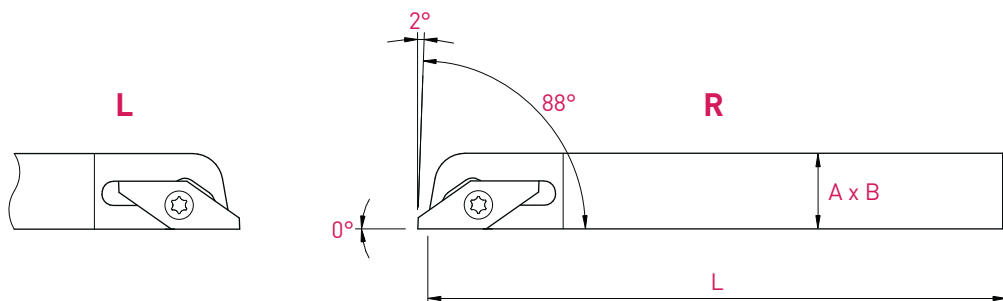

A x B	L	Art. N°	Art. N°
7 x 7	115	311	321
8 x 8	115	312	322
10 x 10	115	313	323
10 x 10	140	-	323-140
12 x 12	115	314	324
12 x 12	90	314-90	324-90
12 x 12	140	314-140	324-140
12.7 x 12.7	140	314-12.7	324-12.7
16 x 16	100	315	325
16 x 16	140	315-140	325-140
20 x 20	120	316	326

Porte-outils

Halter

Holder

88°

310-BC / 320-BC

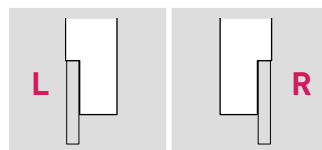
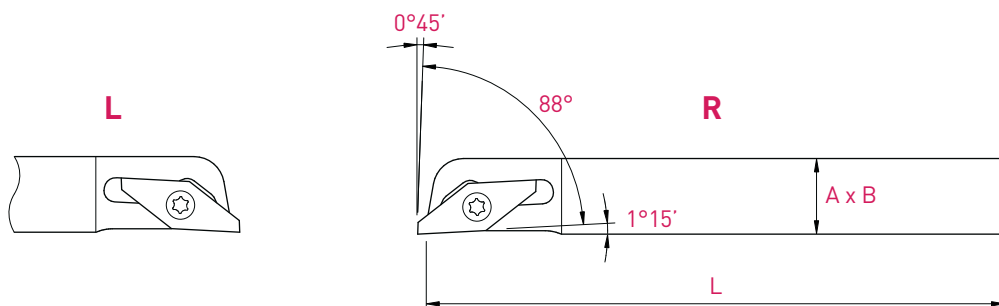

A x B	L	Art. N°	Art. N°
7 x 7	115	311-BC	321-BC
8 x 8	115	312-BC	322-BC
10 x 10	115	313-BC	323-BC
10 x 10	140	-	323-140-BC
12 x 12	115	314-BC	324-BC
12 x 12	90	314-90-BC	324-90-BC
12 x 12	140	314-140-BC	324-140-BC
12.7 x 12.7	140	314-12.7-BC	324-12.7-BC
16 x 16	100	315-BC	325-BC
16 x 16	140	315-140-BC	325-140-BC
20 x 20	120	316-BC	326-BC

Porte-outils Halter Holder	Serrage standard (A) Standard Spannsystem (A) Standard clamping system (A)	
311 / 321	V-M2.5X6.5-T8	C-T8
312 - 316	V-M2.5X7.8-T8	
322 - 326		

Chaque support est livré avec vis et clé.
Jeder Halter wird mit Spannschraube(n) und Schlüssel geliefert.
Screw(s) and key are included with each tool holder.

TURN-LINE

Tournage avant
Vorwärts drehen
Front turning

88°

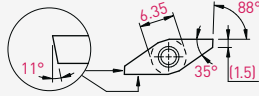

310 / 320

317 / 327

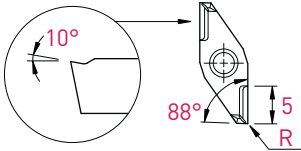

R	Art. N°	L						Art. N°	R					
		TiAlN	TiN	N (µk20)	HTA	HTiN	HN (µk10)		TiAlN	TiN	N (µk20)	HTA	HTiN	HN (µk10)
0	317	■	■	■	■	■	■	327	■	■	■	■	■	■
0.03	317-R03	■	■	■	■	■	■	327-R03	■	■	■	■	■	■
0.08	317-R08	■	■	■	■	■	■	327-R08	■	■	■	■	■	■
0.10	317-R10	■	■	■	■	■	■	327-R10	■	■	■	■	■	■
0.20	317-R20	■	■	■	■	■	■	327-R20	■	■	■	■	■	■

318 / 328

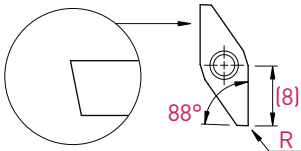

R	Art. N°	L			Art. N°	R		
		HTA	HTiN	HN (µk10)		HTA	HTiN	HN (µk10)
0	318	■	■	■	328	■	■	■
0.05	318-R05	■	■	■	328-R05	■	■	■
0.10	318-R10	■	■	■	328-R10	■	■	■
0.20	318-R20	■	■	■	328-R20	■	■	■
0.40	318-R40	■	■	■	328-R40	■	■	■

318VS / 328VS

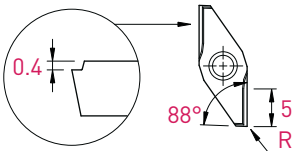

R	Art. N°	L			Art. N°	R		
		HTA	HTiN	HN (µk10)		HTA	HTiN	HN (µk10)
0	318VS	■	■	■	328VS	■	■	■
0.10	318VS-R10	■	■	■	328VS-R10	■	■	■

Tournage avant
Vorwärts drehen
Front turning

88°

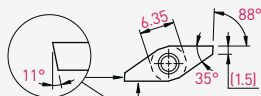

310 / 320

318VX / 328VX

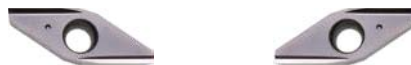
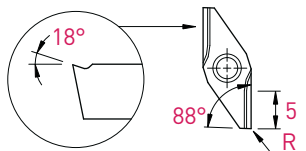

R	Art. N°	L			R			
		HTA	HTiN	HN (µk10)	HTA	HTiN	HN (µk10)	
0	318VX	■	■	■	328VX	■	■	■
0.05	318VX-R05	■	■	■	328VX-R05	■	■	■
0.10	318VX-R10	■	■	■	328VX-R10	■	■	■
0.20	-				328VX-R20	■	■	■
0.40	-				328VX-R40	■	□	■ NEW

318X / 328X

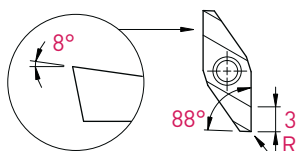

R	Art. N°	L			R			
		HTA	HTiN	HN (µk10)	HTA	HTiN	HN (µk10)	
0	318X	■	■	■	328X	■	■	■
0.10	318X-R10	■	■	■	328X-R10	■	■	■

319 / 329

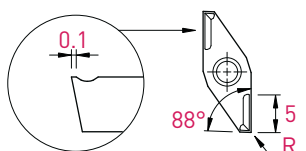

R	Art. N°	L			R			
		HTA	HTiN	HN (µk10)	HTA	HTiN	HN (µk10)	
0	319	■	■	■	329	■	■	■
0.10	319-R10	■	■	■	329-R10	■	■	■
0.20	319-R20	■	■	■	329-R20	■	■	■

■ = disponible / verfügbar / available
□ = selon disponibilité du stock / jenach Lagerverfügbarkeit / depending on stock availability

TURN-LINE

Porte-outils
 Halter
 Holders

85°

330 / 340

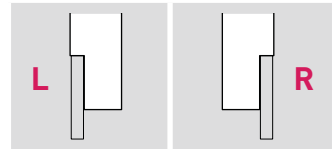
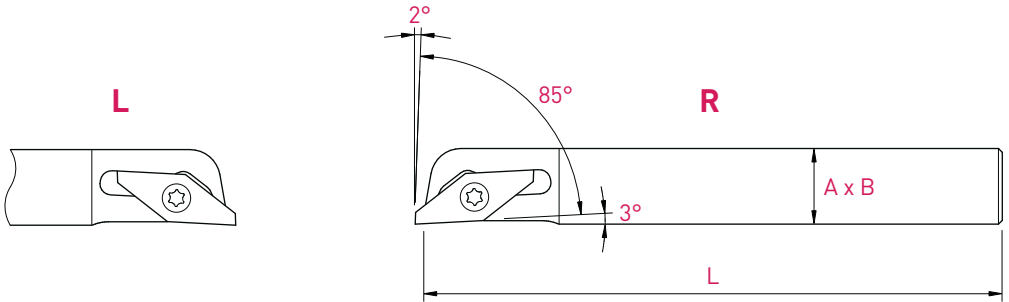

A x B	L	Art. N°	Art. N°
8 x 8	115	332	342
10 x 10	115	333	343
10 x 10	140	-	343-140
12 x 12	115	334	344
12 x 12	90	334-90	344-90
12 x 12	140	334-140	344-140
12.7 x 12.7	140	334-12.7	344-12.7
16 x 16	100	335	345
16 x 16	140	335-140	345-140
20 x 20	120	336	346

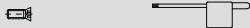
Porte-outils Halter Holders	Serrage standard (A) Standard Spannsystem (A) Standard clamping system (A)
332 - 336 342 - 346	 V-M2.5X7.8-T8 C-T8

Chaque support est livré avec vis et clé.
 Jeder Halter wird mit Spannschraube(n) und Schlüssel geliefert.
 Screw(s) and key are included with each tool holder.

Porte-outils avec arrosage intégré
 Halter mit integrierter Kühlmittelzufuhr
 Holders with integrated coolant supply

85°

340-JET

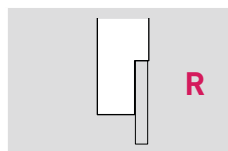
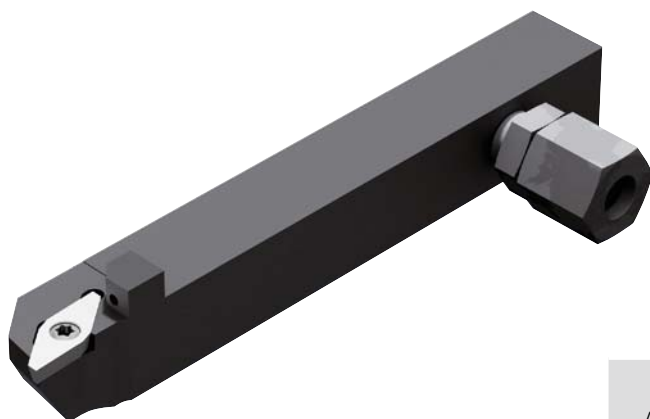
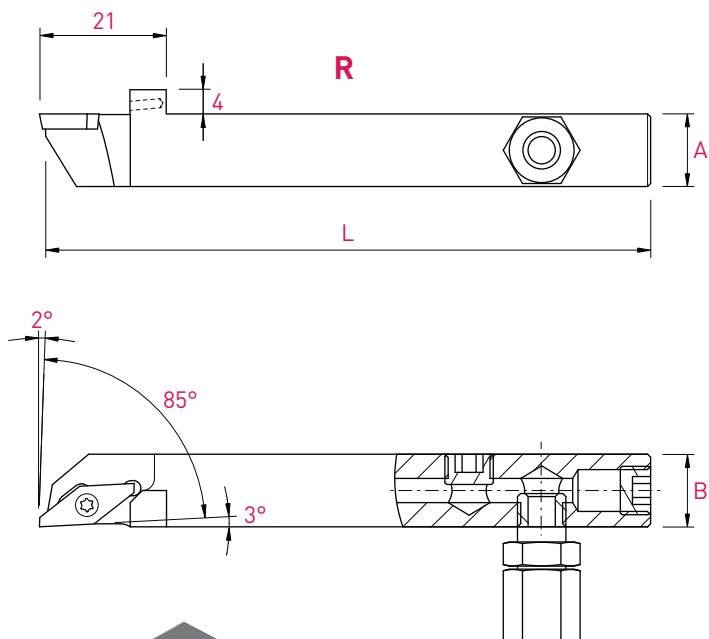

A x B	L	Art. N°
8 x 10	100	340-0810-JET NEW
10 x 12	100	340-1012-JET
12 x 12	100	340-12-JET
12.7 x 12.7	100	340-12.7-JET
16 x 16	100	340-16-JET
20 x 20	100	340-20-JET

Pièces de rechange Ersatzteile Spare parts	Option		
	Art. N°	Art. N°	Art. N°
340-0810-JET	J-M5-D5	JC-M5-D5	JB-M5
340-JET	J-M8X1-D6	-	JB-M8X1

Chaque support est livré avec vis et clé.
 Jeder Halter wird mit Spannschraube(n) und Schlüssel geliefert.
 Screw(s) and key are included with each tool holder.

TURN-LINE

Tournage avant
Vorwärts drehen
Front turning

85°

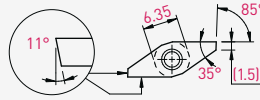

330 / 340

337 / 347

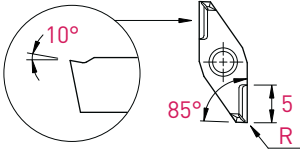

R	Art. N°	L							R							
		TiAlN	TiAlX	TiN	N [µk(20)]	HTA	HTiN	HN [µk(10)]	TiAlN	TiAlX	TiN	N [µk(20)]	HTA	HTiN	HN [µk(10)]	
0	337	■	■	■	■	■	■	■	347	■	■	■	■	■	■	■
0.03	337-R03	■	■	■	■	■	■	■	347-R03	■	■	■	■	■	■	■
0.08	337-R08	■	■	■	■	■	■	■	347-R08	■	■	■	■	■	■	■
0.10	337-R10	■	■	■	■	■	■	■	347-R10	■	■	■	■	■	■	■
0.20	337-R20	■	■	■	■	■	■	■	347-R20	■	■	■	■	■	■	■
0.35	-	■	■	■	■	■	■	■	347-R35	■	■	■	■	■	■	■
0	337-EN	■	■	■	■	■	■	■	347-EN	■	■	■	■	■	■	■
0.03	337-EN-R03	■	□	■	■	■	■	■	347-EN-R03	■	□	■	■	■	■	■
0.08	337-EN-R08	■	□	■	■	■	■	■	347-EN-R08	■	□	■	■	■	■	■
0.10	337-EN-R10	■	■	■	■	■	■	■	347-EN-R10	■	■	■	■	■	■	■
0.20	337-EN-R20	■	□	■	■	■	■	■	347-EN-R20	■	■	■	■	■	■	■
0.35	-	■	■	■	■	■	■	■	347-EN-R35	■	■	■	■	■	■	■

338 / 348

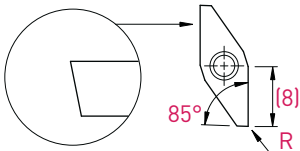

R	Art. N°	L			R			
		HTA	HTiN	HN [µk(10)]	HTA	HTiN	HN [µk(10)]	
0	338	■	■	■	348	■	■	■
0.05	338-R05	■	■	■	348-R05	■	■	■
0.10	338-R10	■	■	■	348-R10	■	■	■
0.20	338-R20	■	■	■	348-R20	■	■	■
0.40	338-R40	■	■	■	348-R40	■	■	■

338VS / 348VS

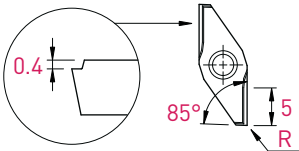

R	Art. N°	L			R			
		HTA	HTiN	HN [µk(10)]	HTA	HTiN	HN [µk(10)]	
0	338VS	■	■	■	348VS	■	■	■
0.10	338VS-R10	■	■	■	348VS-R10	■	■	■

Tournage avant
Vorwärts drehen
Front turning

85°

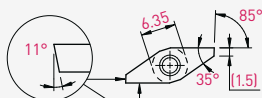

330 / 340

338VX / 348VX

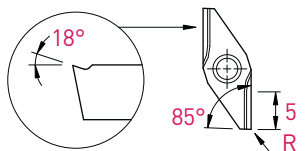

R	Art. N°	L			R		
		HTA	HTiN	HN (µk10)	HTA	HTiN	HN (µk10)
0	338VX	■	■	■	■	■	■
0.05	338VX-R05	■	■	■	■	■	■
0.10	338VX-R10	■	■	■	■	■	■

338X / 348X

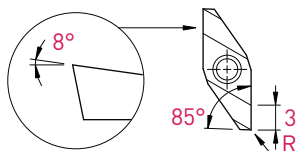

R	Art. N°	L			R		
		HTA	HTiN	HN (µk10)	HTA	HTiN	HN (µk10)
0	338X	■	■	■	■	■	■
0.10	338X-R10	■	■	■	■	■	■

339 / 349

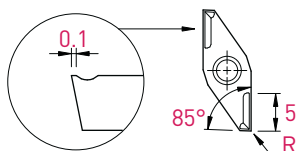

R	Art. N°	L			R		
		HTA	HTiN	HN (µk10)	HTA	HTiN	HN (µk10)
0	339	■	■	■	■	■	■
0.10	339-R10	■	■	■	■	■	■
0.20	339-R20	■	■	■	■	■	■

■ = disponible / verfügbar / available
□ = selon disponibilité du stock / jenach Lagerverfügbarkeit / depending on stock availability

Nouveautés présentées dans ce catalogue
Neuheiten dieses Kataloges
New products introduced in this catalogue



APPLITEC

			page
Géométries de coupe Spanformgeometrien Cutting geometries	Métal dur	ENP-X20	7.05
	VHM	EN-XF3	7.06
	Carbide	EN-MF2	7.06
		EN-HF3	7.07
		CERMET	FN-X8
			ENP-KX
		EN-KM	7.09
Rayon de pointe Eckenradius Corner radius	DCGT...X8/X17	R = 0.08	7.30-7.31
		R = 0.15	7.30-7.31
	VCGT...X8/X17	R = 0.08	7.46-7.47
		R = 0.15	7.46-7.47
Nuances Sorten Grades	Métal dur + PVD	TiX	7.10
	VHM + PVD	HTiX	7.10
	Carbide + PVD	ZTA	7.10
		TiAlX	7.10
		HTAX	7.10
		Métal dur + CVD	Ti5
	VHM + CVD	HTi5	7.11
	Carbide + CVD	Ti6	7.11
	CERMET	CTA	7.11
		CT7	7.11
		HCT7	7.11
		CN6	7.11
Plaquettes et porte-outils 35° type VC-13		VCGT-1303...	7.46-7.49
35° WSP- und Halter typ VC-13		SV...13	7.38 / 7.40 / 7.41
35° inserts and holders type VC-13			
Porte-outils avec arrosage intégré		SC...-JET	7.15
Halter mit integrierter Kühlmittelzufuhr		SD...-JET	7.27
Holders with integrated coolant supply		SV...-JET	7.41
Porte-outils avec section 1/2" x 1/2"		SC...12.7...	7.12-7.15
Halter mit 1/2" x 1/2" Querschnitt		SD...12.7...	7.24-7.28
Holders with 1/2" x 1/2" section		SV...12.7...	7.38-7.42
Paramètres de coupe indicatifs			
Empfohlene Schnittwerte		DATA	7.54-7.57
Standard machining data			

Index

Codification des outils ISO-Line
ISO-Line Bezeichnungssystem
ISO-Line designation system

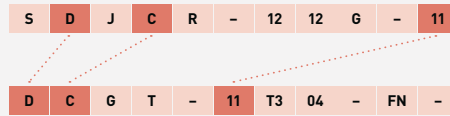

> 7.02

Géométries de coupe
Spanformgeometrien
Cutting geometries



> 7.04

Nuances
Sorten
Grades



> 7.10

Porte-outils et plaquettes 80°
Halter und WSP 80°
Holders and inserts 80°



80° > 7.12

Porte-outils et plaquettes 55°
Halter und WSP 55°
Holders and inserts 55°



55° > 7.24

Porte-outils et plaquettes 35°
Halter und WSP 35°
Holders and inserts 35°



35° > 7.38

Pièces de rechange et accessoires
Ersatzteile und Zubehör
Spare parts and accessories



> 7.53

Paramètres de coupe
Schnittwerte
Machining data

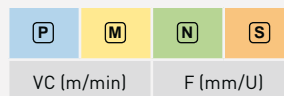

> 7.54

ISO-LINE

Codification des porte-outils ISO-Line

ISO-Line Bezeichnungssystem für Halter

ISO-Line designation system for holders

Méthode de serrage Klemmsystem Clamping system	Forme de la plaquette Plattenform Insert shape	Géométrie du porte-outil Halterform Holder geometry	Angle de dépointe de la plaquette WSP-Freiwinkel Insert clearance angle	Direction de coupe Schneidrichtung Cut direction		Hauteur du porte-outil Halter Höhe Holder height	Largeur du porte-outil Halter-Breite Holder width	Longueur du porte-outil Halter-Länge Holder length		Dimension de la plaquette (L) WSP-Größe (L) Insert size (L)
--	--	---	---	--	--	--	---	--	--	---

S D J C R - 12 12 G - 11

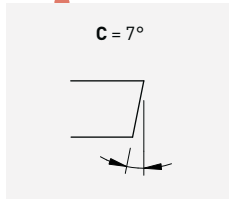
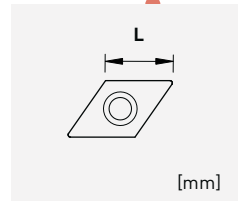
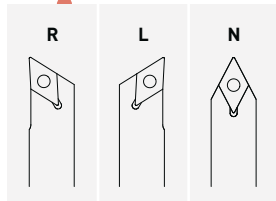

A x B (or Ø) [mm]

- 08 x 08
- 10 x 10
- 12 x 12
- 12.7 x 12.7 (1/2 in)
- 16 x 16
- 20 x 20
- Ø: D10 / D20 / D25.4 (Ø1 in)

Length: [mm]

- F = 75
- G = 90
- J = 110
- X = Special

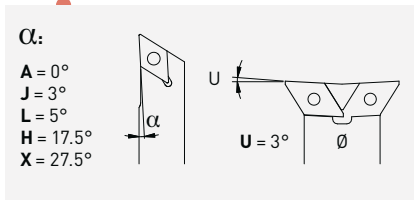

α:

- A = 0°
- J = 3°
- L = 5°
- H = 17.5°
- X = 27.5°

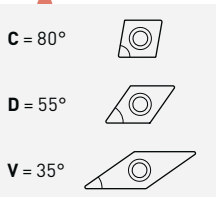

S = vis
Schraube
screw



Compatibilité porte-outil - plaquette
WSP - Halter Kompatibilität
Holder - insert compatibility

S	D	J	C	R	-	12	12	G	-	11
D	C	G	T	-	11	T3	04	-	FN	-

Codification des plaquettes ISO-Line
ISO-Line Bezeichnungssystem für WSP
ISO-Line designation system for inserts

D	C	G	T	-	11	T3	04	-	FN	-	X8															
Forme de la plaquette Plattenform Insert shape	Angle de dépointe de la plaquette WSP-Freiwinkel Insert clearance angle	Classe de tolérance Toleranz Klasse Tolerance class	Brise-copeau Spanbrecher Chip breaker		Dimension de la plaquette (L) WSP Größe (L) Insert size (L)	Épaisseur de la plaquette (E) WSP Dicke (E) Insert thickness (E)	Rayon de pointe de la plaquette WSP Eckenradius Insert corner radius		Exécution d'arête et direction de coupe Schneidkante Ausführung und Schneidrichtung Edge type and cutting direction		Géométrie de coupe Spanformgeometrie Cutting geometry															
		$G = \pm 0.025$ mm $M = \pm 0.05$ mm 				$R:$ 003 = 0.03 mm 005 = 0.05 mm 008 = 0.08 mm 01 = 0.1 mm 015 = 0.15 mm 02 = 0.2 mm 04 = 0.4 mm 08 = 0.8 mm 																				
$C = 80^\circ$ 	$D = 55^\circ$ 				<table border="1"> <thead> <tr> <th>L</th> <th>Ø d [mm]</th> </tr> </thead> <tbody> <tr> <td>CC...06</td> <td></td> </tr> <tr> <td>DC...07</td> <td>6,350</td> </tr> <tr> <td>VC... 11</td> <td></td> </tr> <tr> <td>VC... 13</td> <td>7,940</td> </tr> <tr> <td>CC...09</td> <td></td> </tr> <tr> <td>DC... 11</td> <td>9,525</td> </tr> <tr> <td>VC... 16</td> <td></td> </tr> </tbody> </table>	L	Ø d [mm]	CC... 06		DC... 07	6,350	VC... 11		VC... 13	7,940	CC... 09		DC... 11	9,525	VC... 16						
L	Ø d [mm]																									
CC... 06																										
DC... 07	6,350																									
VC... 11																										
VC... 13	7,940																									
CC... 09																										
DC... 11	9,525																									
VC... 16																										

Géométries de coupe
Spanformgeometrien
Cutting geometries

G
tolerance class

Plaquettes en métal dur rectifiées
VHM geschliffene WSP
Carbide ground inserts

Finishing

FN-X8



8°

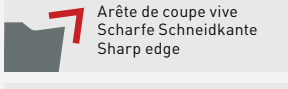

Arête de coupe vive
Scharfe Schneidkante
Sharp edge

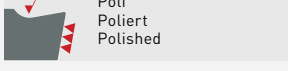

Poli
Poliert
Polished

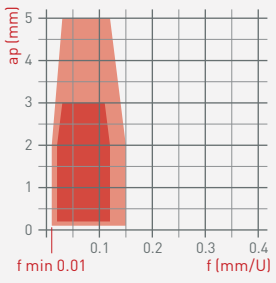

ap (mm)

f (mm/U)

f min 0.01

P	★★★★★
M	★★★★
N	★★★
S	★★★

CCGT DCGT VCGT



p. 7.16 p. 7.30 p. 7.46

Semi-finishing

ENP-X8



8°

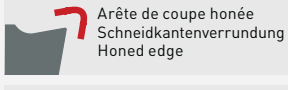

Arête de coupe honée
Schneidkantenverrundung
Honed edge

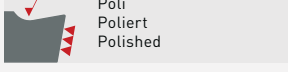

Poli
Poliert
Polished

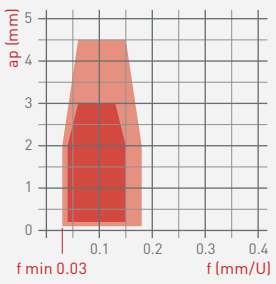

ap (mm)

f (mm/U)

f min 0.03

P	★★★★★
M	★★★
N	★★★
S	★★★

CCGT DCGT VCGT



p. 7.16 p. 7.30 p. 7.46

Finishing

FN-X17



17°

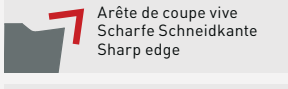

Arête de coupe vive
Scharfe Schneidkante
Sharp edge

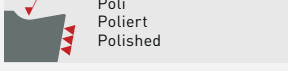

Poli
Poliert
Polished

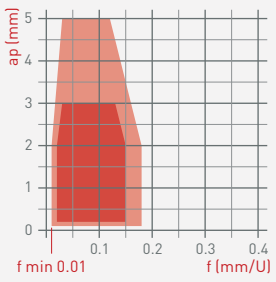

ap (mm)

f (mm/U)

f min 0.01

P	★★★
M	★★★★★
N	★★★★★
S	★★★★★

CCGT DCGT VCGT



p. 7.17 p. 7.31 p. 7.47

Semi-finishing

ENP-X17



17°

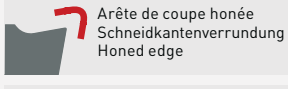

Arête de coupe honée
Schneidkantenverrundung
Honed edge

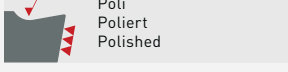

Poli
Poliert
Polished

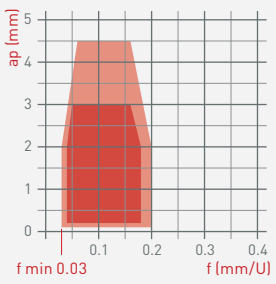

ap (mm)

f (mm/U)

f min 0.03

P	★★★
M	★★★★★
N	★★★
S	★★★★★

CCGT DCGT VCGT



p. 7.17 p. 7.31 p. 7.47

Géométries de coupe
Spanformgeometrien
Cutting geometries

G
tolerance class

Plaquettes en métal dur rectifiées
VHM geschliffene WSP
Carbide ground inserts

Finishing

FN-X25



25°

Arête de coupe vive
Scharfe Schneidkante
Sharp edge

Poli
Poliert
Polished

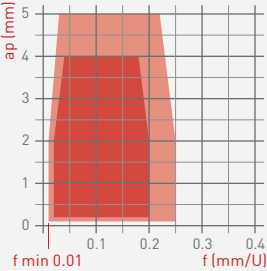

P	
M	★★★
N	★★★★★
S	★★★★★

CCGT DCGT VCGT

p. 7.18 p. 7.32 p. 7.48

Semi-finishing

ENP-X25



25°

Arête de coupe honée
Schneidkantenverrundung
Honed edge

Poli
Poliert
Polished

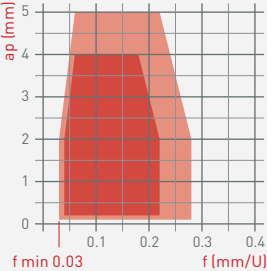

P	
M	★★★
N	★★★★★
S	★★★★★

CCGT DCGT VCGT

p. 7.18 p. 7.32 p. 7.48

Semi-finishing

ENP-X20



20°

Arête de coupe honée
Schneidkantenverrundung
Honed edge

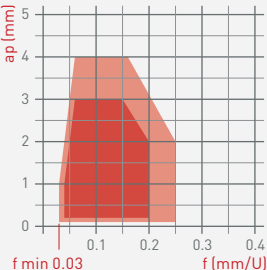

P	
M	★★★★★
N	★★★★
S	★★★★★

CCGT DCGT VCGT

p. 7.19 p. 7.33 p. 7.49

ISO-LINE

Géométries de coupe
Spanformgeometrien
Cutting geometries



M
tolerance class

Plaquettes en métal dur
VHM-Wendeplatten
Carbide inserts

EN-XF3

Semi-finishing

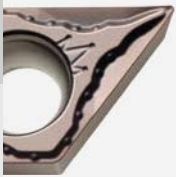
Finishing

12°

Arête de coupe honée
Schneidkantenverrundung
Honed edge

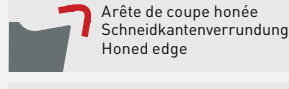
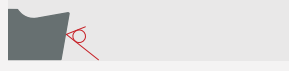
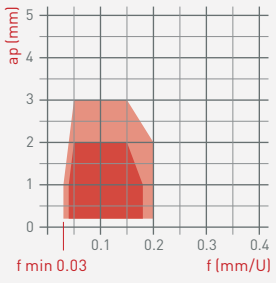

ap (mm)

f (mm/U)

f min 0.03

P	★★★★★
M	★★★★★
N	★★★
S	★★★

CCMT DCMT VCMT







p. 7.20 p. 7.34 p. 7.50

EN-XF2

Semi-finishing

Finishing

6°

Arête de coupe honée
Schneidkantenverrundung
Honed edge

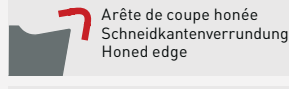
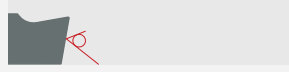
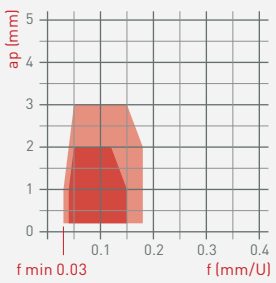

ap (mm)

f (mm/U)

f min 0.03

P	★★★★★
M	★★★
N	
S	★★★



CCMT DCMT VCMT

p. 7.20 p. 7.34 p. 7.50

EN-MF2

Semi-finishing

8°

Arête de coupe honée
Schneidkantenverrundung
Honed edge

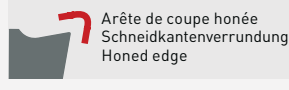
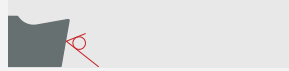
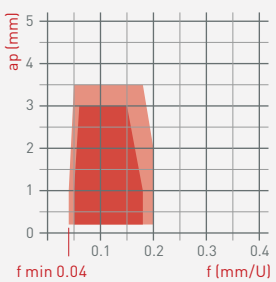

ap (mm)

f (mm/U)

f min 0.04

P	★★★★★
M	★★★★★
N	★★★
S	★★★

CCMT DCMT

p. 7.20 p. 7.34

Géométries de coupe
Spanformgeometrien
Cutting geometries

M
tolerance class

Plaquettes en métal dur
VHM-Wendeplatten
Carbide inserts

EN-MF

Semi-finishing

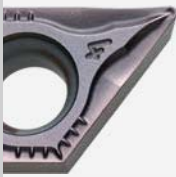

5°

Arête de coupe honée
Schneidkantenverrundung
Honed edge

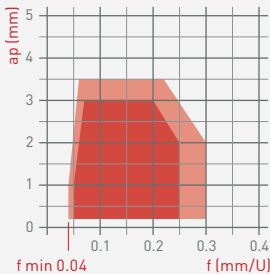

ap (mm)

f (mm/U)

f min 0.04

P	★★★★★
M	★★★
N	
S	

CCMT DCMT VCMT

p. 7.21 p. 7.35 p. 7.51

EN-HF3

Roughing

Semi-finishing

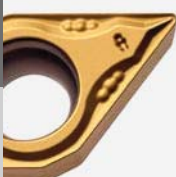

10°

Arête de coupe honée
Schneidkantenverrundung
Honed edge

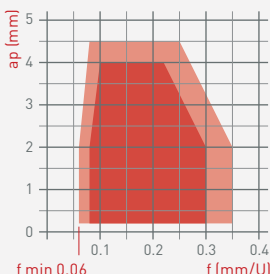

ap (mm)

f (mm/U)

f min 0.06

P	★★★★★
M	★★★★★
N	
S	★★★

CCMT DCMT

p. 7.21 p. 7.35

EN-HF

Roughing

Semi-finishing



12°

Arête de coupe honée
Schneidkantenverrundung
Honed edge

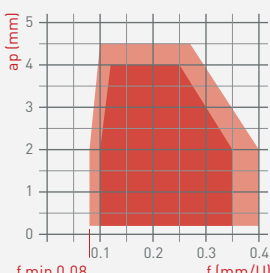

ap (mm)

f (mm/U)

f min 0.08

P	★★★★★
M	★★★★★
N	
S	

CCMT DCMT VCMT

p. 7.21 p. 7.35 p. 7.51

ISO-LINE

Géométries de coupe
Spanformgeometrien
Cutting geometries

G
tolerance class

Plaquettes en métal dur rectifiées
VHM geschliffene WSP
Carbide ground inserts

Super-finishing

FL/FR-X10



10°

Finishing

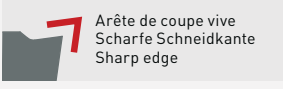

Arête de coupe vive
Scharfe Schneidkante
Sharp edge

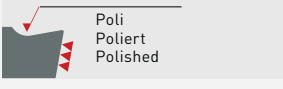

Poli
Poliert
Polished

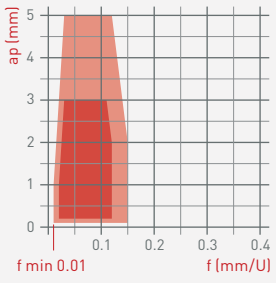

ap (mm)

f min 0.01

f (mm/U)

P	★★★★★
M	★★★★★
N	★★★★★
S	★★★★★

VCGT



p. 7.44

Semi-finishing

ELP/ERP-X10



10°

Finishing

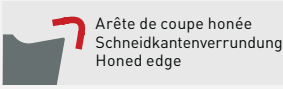

Arête de coupe honée
Schneidkantenverrundung
Honed edge

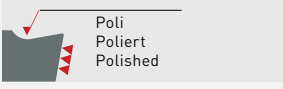

Poli
Poliert
Polished

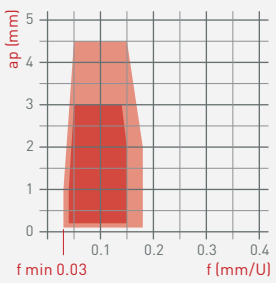

ap (mm)

f min 0.03

f (mm/U)

P	★★★★★
M	★★★★★
N	★★★
S	★★★

VCGT



p. 7.44

Super-finishing

FN-K18



18°

Finishing

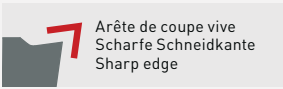

Arête de coupe vive
Scharfe Schneidkante
Sharp edge



Poli
Poliert
Polished

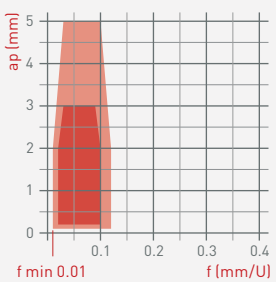

ap (mm)

f min 0.01

f (mm/U)

P	★★★★★
M	★★★★★
N	★★★★★
S	★★★★★

VCGT



p. 7.45

Finishing

FN-0

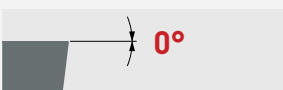

0°

Finishing

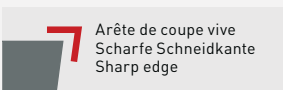

Arête de coupe vive
Scharfe Schneidkante
Sharp edge

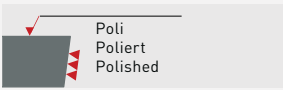

Poli
Poliert
Polished

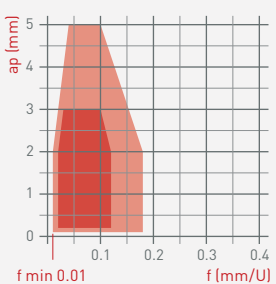

ap (mm)

f min 0.01

f (mm/U)

P	★★★
M	
N	★★★
S	

VCGW



p. 7.45

Géométries de coupe
Spanformgeometrien
Cutting geometries

G/M
tolerance class

CERMET

Finishing

FN-X8 CERMET



8°

Arête de coupe vive
Scharfe Schneidkante
Sharp edge

Poli
Poliert
Polished

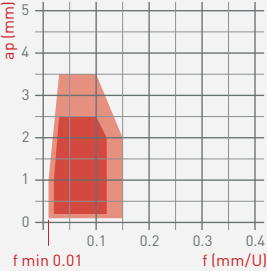

ap (mm)

f (mm/U)

f min 0.01

P	★★★★★
M	★★★
N	
S	

CCGT DCGT VCGT

p. 7.22 p. 7.36 p. 7.52

Semi-finishing

ENP-KX CERMET



8°

Arête de coupe honée
Schneidkantenverrundung
Honed edge

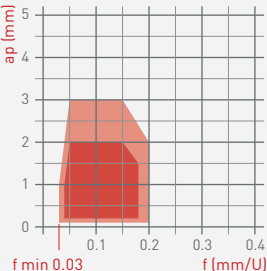

ap (mm)

f (mm/U)

f min 0.03

P	★★★★★
M	★★★
N	
S	

CCGT DCGT

p. 7.22 p. 7.36

Semi-finishing

EN-KM CERMET



8°

Arête de coupe honée
Schneidkantenverrundung
Honed edge

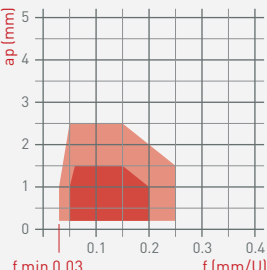

ap (mm)

f (mm/U)

f min 0.03

P	★★★★★
M	★★★
N	
S	

CCMT DCMT

p. 7.23 p. 7.37

Nuances

Sorten

Grades

Nuances Sorten Grades	Domaine d'application Anwendungsbereich Application area	Finishing / light machining	Semi-finishing / medium cut	Roughing / heavy machining	Géométries de coupe disponibles Verfügbare Spanformgeometrien Available cutting geometries	Résistance à l'usure Verschleißfestigkeit Wear resistance	Ténacité, résistance à la rupture Zähigkeit, Bruchwiderstand Toughness, crack resistance	Résistance à la température Bearbeitungswarmfestigkeit Machining heat resistance	Revêtement et couleur Beschichtung und Farbe Coating and colour	Recommandations spéciales Sonder-Empfehlungen Special recommendations
Carbide + PVD										
TiAlN	★★★★★ ★★★★★ ★★★★★ ★★★★	■	■	■	FN/ENP-X8 FN/ENP-X17 FN/ENP-X25 L/R-X10	■■■■■□	■■■■■□	■■■■■□	PVD	
HTA	★★★★★ ★★★★★ ★★★★★ ★★★★	■			FN-X8 FN-X17 FN-X25 L/R-X10 FN-K18 FN-0	■■■■■	■■■■■□	■■■■■□	PVD	
TiN	★★★★ ★★★★ ★★★★★	■	■	■	FN/ENP-X8 FN/ENP-X17 FN/ENP-X25 L/R-X10	■■■■□□	■■■■□□	■■■■□□	PVD	High resistance to edge build up
HTiN	★★★★ ★★★★ ★★★★★	■			FN-K18 FN-0	■■■■■□	■■■■□□	■■■■□□	PVD	High resistance to edge build up
TAC	★★★★★ ★★★★★ ★★★★★ ★★★★	■	■	■	EN-XF3 EN-XF2 EN-MF2 EN-HF	■■■■■□	■■■■■□	■■■■■□	PVD	
HTAC	★★★★★ ★★★★★ ★★★★★ ★★★★	■	■		EN-XF3 EN-XF2 EN-MF2	■■■■■	■■■■□□	■■■■■□	PVD	
TiX	★★★★★ ★★★★★ ★★★★			■	EN-HF3	■■■■□□	■■■■□□	■■■■□□	PVD	Easy wear out control with TiN top layer
HTiX	★★★★★ ★★★★★ ★★★★★ ★★★★	■	■		ENP-X20 EN-HF3	■■■■■□	■■■■□□	■■■■□□	PVD	Easy wear out control with TiN top layer
Tmax	★★★★★ ★★★★★ ★★★★★ ★★★★	■	■		EN-MF EN-HF	■■■■■□	■■■■■□	■■■■■□	PVD	
ZTA	★★★★★ ★★★★★ ★★★★★	■	■		ENP-X20	■■■■■□	■■■■■□	■■■■■□	PVD	perfect for titanium alloys & superalloys
TiAlX	★★★★ ★★★★ ★★★★	■	■		R-X10	■■■■■□	■■■■■□	■■■■■□	PVD	perfect for titanium alloys & superalloys
HTAX	★★★★ ★★★★ ★★★★	■			R-X10	■■■■■	■■■■□□	■■■■■□	PVD	perfect for titanium alloys & superalloys

Nuances

Sorten

Grades

Nuances Sorten Grades	Domaine d'application Anwendungsbereich Application area	Finishing / light machining	Semi-finishing / medium cut	Roughing / heavy machining	Géométries de coupe disponibles Verfügbare Spanformgeometrien Available cutting geometries	Résistance à l'usure Verschleißfestigkeit Wear resistance	Ténacité, résistance à la rupture Zähigkeit, Bruchwiderstand Toughness, crack resistance	Résistance à la température Bearbeitungswarmfestigkeit Machining heat resistance	Revêtement et couleur Beschichtung und Farbe Coating and colour	Recommandations spéciales Sonder-Empfehlungen Special recommendations
Carbide + CVD										
Ti4	★★★★★ ★★★		■	■	EN-MF EN-HF3 EN-HF	■■■■■□	■■■■■□	■■■■■	CVD	
Ti5	★★★★★ ★★★		■	■	EN-MF2 EN-HF	■■■■■□	■■■■■□	■■■■■	CVD	Easy wear out control with TiN top layer
HTi5	★★★★★ ★★★		■	■	EN-XF2 EN-MF2 EN-HF	■■■■■	■■■■□□	■■■■■	CVD	Easy wear out control with TiN top layer
Ti6	★★★ ★★★★★ ★★★★		■	■	EN-HF3	■■■■■□	■■■■■□	■■■■■	CVD	
Carbide uncoated										
K10	★★★ ★★★		■		FN-X8 FN-X17 FN-X25 ELP-X10/ERP-X10 FN-K18 FN-0	■■■■□□	■■■■□□	■■■■□□	uncoated	
K20	★★ ★★		■		FN/ENP-X8 FN/ENP-X17 FN/ENP-X25 ELP-X10/ERP-X10	■■■■□□	■■■■□□	■■■■□□	uncoated	
CERMET										
CTA	★★★★★ ★★★		■		FN-X8	■■■■■□	■■■■■□	■■■■■	CERMET +PVD	
CT7	★★★★★ ★★★		■	■	ENP-KX EN-KM	■■■■■□	■■■■■□	■■■■■	CERMET + PVD	Easy wear out control with TiN top layer
HCT7	★★★★★ ★★★		■	■	ENP-KX EN-KM	■■■■■	■■■■□□	■■■■■	CERMET + PVD	Easy wear out control with TiN top layer
CN6	★★★★		■		FN-X8 ENP-KX EN-KM	■■■■□□	■■■■■□	■■■■■□	CERMET uncoated	

ISO-LINE

Outils de tournage 80°

80°-Drehwerkzeuge

Turning tools 80°

80°



SCM



SCA



SCL

Porte-outils

Halter

Holder

80°

SCM

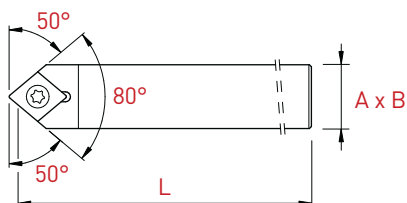

Plaquettes WSP Inserts	A x B x L	Art. N°
CC...-0602..	8 x 8 x 115	SCMCN-0808X-06
	10 x 10 x 115	SCMCN-1010X-06
	12 x 12 x 130	SCMCN-1212X-06
	12 x 12 x 90	SCMCN-1212G-06
	12.7 x 12.7 x 130	SCMCN-12.7-X-06
	16 x 16 x 130	SCMCN-1616X-06
	16 x 16 x 75	SCMCN-1616F-06
CC...-09T3..	12 x 12 x 130	SCMCN-1212X-09
	12 x 12 x 90	SCMCN-1212G-09
	12.7 x 12.7 x 130	SCMCN-12.7-X-09
	16 x 16 x 130	SCMCN-1616X-09
	16 x 16 x 75	SCMCN-1616F-09
	20 x 20 x 120	SCMCN-2020X-09

Porte-outils

Halter

Holders

80°

SCA

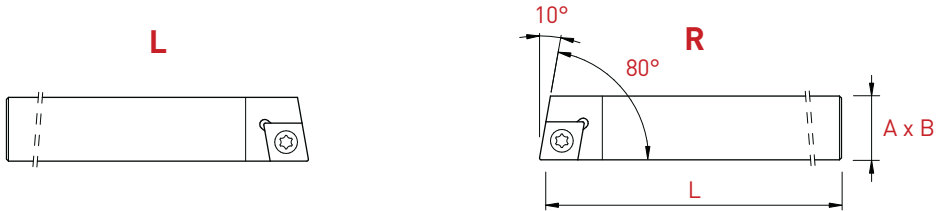

Plaquettes WSP Inserts	A x B x L	Art. N°	Art. N°
CC..-0602..	8 x 8 x 115	SCACL-0808X-06	SCACR-0808X-06
	10 x 10 x 115	SCACL-1010X-06	SCACR-1010X-06
	12 x 12 x 130	SCACL-1212X-06	SCACR-1212X-06
	12 x 12 x 90	SCACL-1212G-06	SCACR-1212G-06
	12.7 x 12.7 x 130	SCACL-12.7-X-06	SCACR-12.7-X-06
	16 x 16 x 130	SCACL-1616X-06	SCACR-1616X-06
	16 x 16 x 75	SCACL-1616F-06	SCACR-1616F-06
CC..-09T3..	12 x 12 x 130	SCACL-1212X-09	SCACR-1212X-09
	12 x 12 x 90	SCACL-1212G-09	SCACR-1212G-09
	12.7 x 12.7 x 130	SCACL-12.7-X-09	SCACR-12.7-X-09
	16 x 16 x 130	SCACL-1616X-09	SCACR-1616X-09
	16 x 16 x 75	SCACL-1616F-09	SCACR-1616F-09
	20 x 20 x 120	SCACL-2020X-09	SCACR-2020X-09

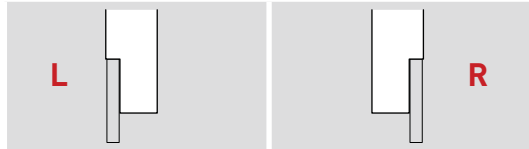
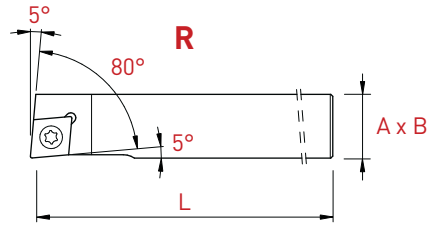
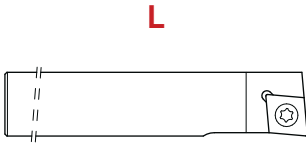

Plaquettes WSP Inserts	A x B x L	Art. N°	Art. N°
CC..-0602..	8 x 8 x 115	SCLCL-0808X-06	SCLCR-0808X-06
	10 x 10 x 115	SCLCL-1010X-06	SCLCR-1010X-06
	12 x 12 x 130	SCLCL-1212X-06	SCLCR-1212X-06
	12 x 12 x 90	SCLCL-1212G-06	SCLCR-1212G-06
	12.7 x 12.7 x 130	SCLCL-12.7-X-06	SCLCR-12.7-X-06
	16 x 16 x 130	SCLCL-1616X-06	SCLCR-1616X-06
	16 x 16 x 75	SCLCL-1616F-06	SCLCR-1616F-06
CC..-09T3..	12 x 12 x 130	SCLCL-1212X-09	SCLCR-1212X-09
	12 x 12 x 90	SCLCL-1212G-09	SCLCR-1212G-09
	12.7 x 12.7 x 130	SCLCL-12.7-X-09	SCLCR-12.7-X-09
	16 x 16 x 130	SCLCL-1616X-09	SCLCR-1616X-09
	16 x 16 x 75	SCLCL-1616F-09	SCLCR-1616F-09
	20 x 20 x 120	SCLCL-2020X-09	SCLCR-2020X-09

Porte-outils avec arrosage intégré
 Halter mit integrierter Kühlmittelzufuhr
 Holders with integrated coolant supply

80°

SCL-JET

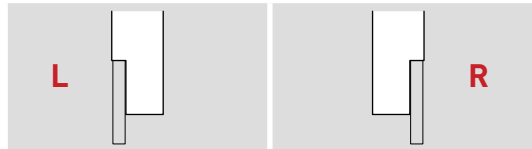
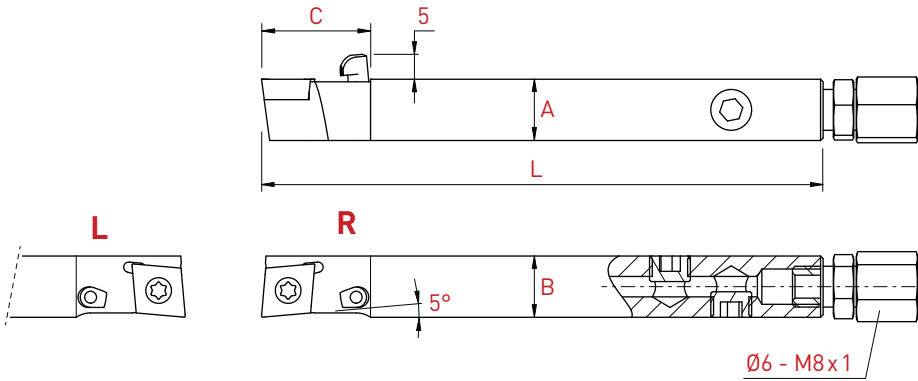

Plaquettes WSP Inserts	A x B x L	C	Art. N°	Art. N°
CC...-0602..	10 x 10 x 110	21	SCLCL-1010J-06-JET	SCLCR-1010J-06-JET
	12 x 12 x 110	21	SCLCL-1212J-06-JET	SCLCR-1212J-06-JET
	12.7 x 12.7 x 110	21	SCLCL-12.7-J-06-JET	SCLCR-12.7-J-06-JET
	16 x 16 x 110	21	SCLCL-1616J-06-JET	SCLCR-1616J-06-JET
CC...-09T3..	12 x 12 x 110	21	SCLCL-1212J-09-JET	SCLCR-1212J-09-JET
	12.7 x 12.7 x 110	21	SCLCL-12.7-J-09-JET	SCLCR-12.7-J-09-JET
	16 x 16 x 110	21	SCLCL-1616J-09-JET	SCLCR-1616J-09-JET
	20 x 20 x 110	21	SCLCL-2020J-09-JET	SCLCR-2020J-09-JET

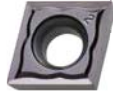

CCGT
FN-X8

R	Art. N°	PVD			non revêtu unbeschichtet uncoated	
		TiAlN	HTA	TiN	K10	K20
		P M N S	P M N S	P M N		
0.05	CCGT-0602005-FN-X8	■	■	■	■	■
0.1	CCGT-060201-FN-X8	■	■	■	■	■
0.2	CCGT-060202-FN-X8	■	■	■	■	■
0.4	CCGT-060204-FN-X8	■	■	■	■	■
0.05	CCGT-09T3005-FN-X8	■	■	■	■	■
0.1	CCGT-09T301-FN-X8	■	■	■	■	■
0.2	CCGT-09T302-FN-X8	■	■	■	■	■
0.4	CCGT-09T304-FN-X8	■	■	■	■	■

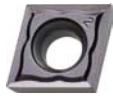
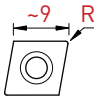

CCGT
ENP-X8

R	Art. N°	PVD		non revêtu unbeschichtet uncoated
		TiAlN	TiN	K20
		P M N S	P M N	
0.05	CCGT-0602005-ENP-X8	■	■	■
0.1	CCGT-060201-ENP-X8	■	■	■
0.2	CCGT-060202-ENP-X8	■	■	■
0.4	CCGT-060204-ENP-X8	■	■	■
0.05	CCGT-09T3005-ENP-X8	■	■	■
0.1	CCGT-09T301-ENP-X8	■	■	■
0.2	CCGT-09T302-ENP-X8	■	■	■
0.4	CCGT-09T304-ENP-X8	■	■	■

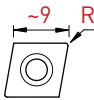

Plaquettes en métal dur

VHM-Wendeplatten

Solid carbide inserts

80°

CCGT-X17



CCGT
FN-X17

R	Art. N°	PVD			non revêtu unbeschichtet uncoated	
		TiAlN	HTA	TiN	K10	K20
0.05	CCGT-0602005-FN-X17	<input checked="" type="checkbox"/>	<input checked="" type="checkbox"/>	<input checked="" type="checkbox"/>	<input type="checkbox"/>	<input type="checkbox"/>
0.1	CCGT-060201-FN-X17	<input checked="" type="checkbox"/>	<input checked="" type="checkbox"/>	<input checked="" type="checkbox"/>	<input type="checkbox"/>	<input type="checkbox"/>
0.2	CCGT-060202-FN-X17	<input checked="" type="checkbox"/>	<input checked="" type="checkbox"/>	<input checked="" type="checkbox"/>	<input type="checkbox"/>	<input type="checkbox"/>
0.4	CCGT-060204-FN-X17	<input checked="" type="checkbox"/>	<input checked="" type="checkbox"/>	<input checked="" type="checkbox"/>	<input type="checkbox"/>	<input type="checkbox"/>
0.05	CCGT-09T3005-FN-X17	<input checked="" type="checkbox"/>	<input checked="" type="checkbox"/>	<input checked="" type="checkbox"/>	<input type="checkbox"/>	<input type="checkbox"/>
0.1	CCGT-09T301-FN-X17	<input checked="" type="checkbox"/>	<input checked="" type="checkbox"/>	<input checked="" type="checkbox"/>	<input type="checkbox"/>	<input type="checkbox"/>
0.2	CCGT-09T302-FN-X17	<input checked="" type="checkbox"/>	<input checked="" type="checkbox"/>	<input checked="" type="checkbox"/>	<input type="checkbox"/>	<input type="checkbox"/>
0.4	CCGT-09T304-FN-X17	<input checked="" type="checkbox"/>	<input checked="" type="checkbox"/>	<input checked="" type="checkbox"/>	<input type="checkbox"/>	<input type="checkbox"/>
0.8	CCGT-09T308-FN-X17	<input checked="" type="checkbox"/>	<input checked="" type="checkbox"/>	<input checked="" type="checkbox"/>	<input type="checkbox"/>	<input type="checkbox"/>

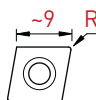

CCGT
ENP-X17

R	Art. N°	PVD		non revêtu unbeschichtet uncoated
		TiAlN	TiN	K20
0.05	CCGT-0602005-ENP-X17	<input checked="" type="checkbox"/>	<input checked="" type="checkbox"/>	<input type="checkbox"/>
0.1	CCGT-060201-ENP-X17	<input checked="" type="checkbox"/>	<input checked="" type="checkbox"/>	<input type="checkbox"/>
0.2	CCGT-060202-ENP-X17	<input checked="" type="checkbox"/>	<input checked="" type="checkbox"/>	<input type="checkbox"/>
0.4	CCGT-060204-ENP-X17	<input checked="" type="checkbox"/>	<input checked="" type="checkbox"/>	<input type="checkbox"/>
0.05	CCGT-09T3005-ENP-X17	<input checked="" type="checkbox"/>	<input checked="" type="checkbox"/>	<input type="checkbox"/>
0.1	CCGT-09T301-ENP-X17	<input checked="" type="checkbox"/>	<input checked="" type="checkbox"/>	<input type="checkbox"/>
0.2	CCGT-09T302-ENP-X17	<input checked="" type="checkbox"/>	<input checked="" type="checkbox"/>	<input type="checkbox"/>
0.4	CCGT-09T304-ENP-X17	<input checked="" type="checkbox"/>	<input checked="" type="checkbox"/>	<input type="checkbox"/>
0.8	CCGT-09T308-ENP-X17	<input checked="" type="checkbox"/>	<input checked="" type="checkbox"/>	<input type="checkbox"/>



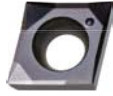

CCGT
FN-X25

R	Art. N°	PVD			non revêtu unbeschichtet uncoated	
		TiAlN	HTA	TiN	K10	K20
0.05	CCGT-0602005-FN-X25	<input checked="" type="checkbox"/>	<input checked="" type="checkbox"/>	<input checked="" type="checkbox"/>	<input type="checkbox"/>	<input type="checkbox"/>
0.1	CCGT-060201-FN-X25	<input checked="" type="checkbox"/>	<input checked="" type="checkbox"/>	<input checked="" type="checkbox"/>	<input type="checkbox"/>	<input type="checkbox"/>
0.2	CCGT-060202-FN-X25	<input checked="" type="checkbox"/>	<input checked="" type="checkbox"/>	<input checked="" type="checkbox"/>	<input type="checkbox"/>	<input type="checkbox"/>
0.4	CCGT-060204-FN-X25	<input checked="" type="checkbox"/>	<input checked="" type="checkbox"/>	<input checked="" type="checkbox"/>	<input type="checkbox"/>	<input type="checkbox"/>
0.05	CCGT-09T3005-FN-X25	<input checked="" type="checkbox"/>	<input checked="" type="checkbox"/>	<input checked="" type="checkbox"/>	<input type="checkbox"/>	<input type="checkbox"/>
0.1	CCGT-09T301-FN-X25	<input checked="" type="checkbox"/>	<input checked="" type="checkbox"/>	<input checked="" type="checkbox"/>	<input type="checkbox"/>	<input type="checkbox"/>
0.2	CCGT-09T302-FN-X25	<input checked="" type="checkbox"/>	<input checked="" type="checkbox"/>	<input checked="" type="checkbox"/>	<input type="checkbox"/>	<input type="checkbox"/>
0.4	CCGT-09T304-FN-X25	<input checked="" type="checkbox"/>	<input checked="" type="checkbox"/>	<input checked="" type="checkbox"/>	<input type="checkbox"/>	<input type="checkbox"/>
0.8	CCGT-09T308-FN-X25	<input checked="" type="checkbox"/>	<input checked="" type="checkbox"/>	<input checked="" type="checkbox"/>	<input type="checkbox"/>	<input type="checkbox"/>

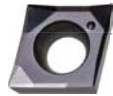

CCGT
ENP-X25

R	Art. N°	PVD		non revêtu unbeschichtet uncoated
		TiAlN	TiN	K20
0.05	CCGT-0602005-ENP-X25	<input checked="" type="checkbox"/>	<input checked="" type="checkbox"/>	<input type="checkbox"/>
0.1	CCGT-060201-ENP-X25	<input checked="" type="checkbox"/>	<input checked="" type="checkbox"/>	<input type="checkbox"/>
0.2	CCGT-060202-ENP-X25	<input checked="" type="checkbox"/>	<input checked="" type="checkbox"/>	<input type="checkbox"/>
0.4	CCGT-060204-ENP-X25	<input checked="" type="checkbox"/>	<input checked="" type="checkbox"/>	<input type="checkbox"/>
0.05	CCGT-09T3005-ENP-X25	<input checked="" type="checkbox"/>	<input checked="" type="checkbox"/>	<input type="checkbox"/>
0.1	CCGT-09T301-ENP-X25	<input checked="" type="checkbox"/>	<input checked="" type="checkbox"/>	<input type="checkbox"/>
0.2	CCGT-09T302-ENP-X25	<input checked="" type="checkbox"/>	<input checked="" type="checkbox"/>	<input type="checkbox"/>
0.4	CCGT-09T304-ENP-X25	<input checked="" type="checkbox"/>	<input checked="" type="checkbox"/>	<input type="checkbox"/>
0.8	CCGT-09T308-ENP-X25	<input checked="" type="checkbox"/>	<input checked="" type="checkbox"/>	<input type="checkbox"/>



Plaquettes en métal dur

VHM-Wendeplatten

Solid carbide inserts

80°

CCGT-X20

CCGT
ENP-X20

PVD



R	Art. N°	ZTA	HTIX
0.1	CCGT-060201-ENP-X20	■	
0.2	CCGT-060202-ENP-X20	■	■
0.4	CCGT-060204-ENP-X20	■	■
0.1	CCGT-09T301-ENP-X20	■	
0.2	CCGT-09T302-ENP-X20	■	■
0.4	CCGT-09T304-ENP-X20	■	■
0.8	CCGT-09T308-ENP-X20	■	■

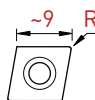

Plaquettes en métal dur
VHM-Wendplatten
Solid carbide inserts

80°

CCMT-XF3
CCMT-XF2
CCMT-MF2



**CCMT
EN-XF3**

PVD	
<input type="checkbox"/> P	<input type="checkbox"/> P
<input type="checkbox"/> M	<input type="checkbox"/> M
<input type="checkbox"/> N	<input type="checkbox"/> N
<input type="checkbox"/> S	<input type="checkbox"/> S
TAC	HTAC

R	Art. N°	TAC	HTAC
0.2	CCMT-060202-EN-XF3	<input type="checkbox"/>	<input type="checkbox"/>
0.4	CCMT-060204-EN-XF3	<input type="checkbox"/>	<input type="checkbox"/>
0.2	CCMT-09T302-EN-XF3	<input type="checkbox"/>	<input type="checkbox"/>
0.4	CCMT-09T304-EN-XF3	<input type="checkbox"/>	<input type="checkbox"/>



**CCMT
EN-XF2**

PVD		CVD
<input type="checkbox"/> P	<input type="checkbox"/> P	<input type="checkbox"/> P
<input type="checkbox"/> M	<input type="checkbox"/> M	<input type="checkbox"/> M
<input type="checkbox"/> N	<input type="checkbox"/> N	<input type="checkbox"/>
<input type="checkbox"/> S	<input type="checkbox"/> S	<input type="checkbox"/>
TAC	HTAC	HTi5

R	Art. N°	TAC	HTAC	HTi5
0.2	CCMT-060202-EN-XF2	<input type="checkbox"/>	<input type="checkbox"/>	<input type="checkbox"/>
0.4	CCMT-060204-EN-XF2	<input type="checkbox"/>	<input type="checkbox"/>	<input type="checkbox"/>
0.2	CCMT-09T302-EN-XF2	<input type="checkbox"/>	<input type="checkbox"/>	<input type="checkbox"/>
0.4	CCMT-09T304-EN-XF2	<input type="checkbox"/>	<input type="checkbox"/>	<input type="checkbox"/>

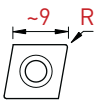

**CCMT
EN-MF2**

PVD		CVD	
<input type="checkbox"/> P	<input type="checkbox"/> P	<input type="checkbox"/> P	<input type="checkbox"/> P
<input type="checkbox"/> M	<input type="checkbox"/> M	<input type="checkbox"/> M	<input type="checkbox"/> M
<input type="checkbox"/> N	<input type="checkbox"/> N	<input type="checkbox"/>	<input type="checkbox"/>
<input type="checkbox"/> S	<input type="checkbox"/> S	<input type="checkbox"/>	<input type="checkbox"/>
TAC	HTAC	Ti5	HTi5

R	Art. N°	TAC	HTAC	Ti5	HTi5
0.2	CCMT-060202-EN-MF2	<input type="checkbox"/>	<input type="checkbox"/>	<input type="checkbox"/>	<input type="checkbox"/>
0.4	CCMT-060204-EN-MF2	<input type="checkbox"/>	<input type="checkbox"/>	<input type="checkbox"/>	<input type="checkbox"/>
0.2	CCMT-09T302-EN-MF2	<input type="checkbox"/>	<input type="checkbox"/>	<input type="checkbox"/>	<input type="checkbox"/>
0.4	CCMT-09T304-EN-MF2	<input type="checkbox"/>	<input type="checkbox"/>	<input type="checkbox"/>	<input type="checkbox"/>
0,8	CCMT-09T308-EN-MF2	<input type="checkbox"/>	<input type="checkbox"/>	<input type="checkbox"/>	<input type="checkbox"/>

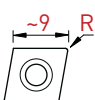

Plaquettes en métal dur

VHM-Wendepplatten

Solid carbide inserts

80°

CCMT-MF

CCMT-HF3

CCMT-HF



CCMT
EN-MF

R	Art. N°	PVD		CVD	
		Tmax	Ti4	Ti4	Ti4
0.2	CCMT-060202-EN-MF	■	■	■	■
0.4	CCMT-060204-EN-MF	■	■	■	■
0.2	CCMT-09T302-EN-MF	■	■	■	■
0.4	CCMT-09T304-EN-MF	■	■	■	■

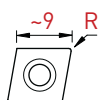

CCMT
EN-HF3

R	Art. N°	PVD		CVD	
		TiX	HTiX	Ti6	Ti6
0,2	CCMT-060202-EN-HF3	■	■	■	■
0.4	CCMT-060204-EN-HF3	■	■	■	■
0,2	CCMT-09T302-EN-HF3	■	■	■	■
0.4	CCMT-09T304-EN-HF3	■	■	■	■
0.8	CCMT-09T308-EN-HF3	■	■	■	■



CCMT
EN-HF

R	Art. N°	PVD		CVD		
		Tmax	TAC	Ti4	Ti5	HTi5
0.2	CCMT-060202-EN-HF	■	■	■	■	■
0.4	CCMT-060204-EN-HF	■	■	■	■	■
0.8	CCMT-060208-EN-HF	■	■	■	■	■
0.2	CCMT-09T302-EN-HF	■	■	■	■	■
0.4	CCMT-09T304-EN-HF	■	■	■	■	■
0.8	CCMT-09T308-EN-HF	■	■	■	■	■





CCGT
 FN-X8

		CERMET	
		PVD	non revêtu unbeschichtet uncoated
		<input type="checkbox"/> P <input type="checkbox"/> M <input type="checkbox"/>	<input type="checkbox"/> P <input type="checkbox"/>
		CTA	CN6
R	Art. N°		
0.05	CCGT-0602005-FN-X8	<input checked="" type="checkbox"/>	<input checked="" type="checkbox"/>
0.1	CCGT-060201-FN-X8	<input checked="" type="checkbox"/>	<input checked="" type="checkbox"/>
0.2	CCGT-060202-FN-X8	<input checked="" type="checkbox"/>	<input checked="" type="checkbox"/>
0.05	CCGT-09T3005-FN-X8	<input checked="" type="checkbox"/>	<input checked="" type="checkbox"/>
0.1	CCGT-09T301-FN-X8	<input checked="" type="checkbox"/>	<input checked="" type="checkbox"/>
0.2	CCGT-09T302-FN-X8	<input checked="" type="checkbox"/>	<input checked="" type="checkbox"/>
0.4	CCGT-09T304-FN-X8	<input checked="" type="checkbox"/>	<input checked="" type="checkbox"/>



CCGT
 ENP-KX

		CERMET		
		PVD		non revêtu unbeschichtet uncoated
		<input type="checkbox"/> P <input checked="" type="checkbox"/> M <input type="checkbox"/>	<input type="checkbox"/> P <input checked="" type="checkbox"/> M <input type="checkbox"/>	<input type="checkbox"/> P <input type="checkbox"/>
		CT7	HCT7	CN6
R	Art. N°			
0.1	CCGT-060201-ENP-KX	<input checked="" type="checkbox"/>	<input checked="" type="checkbox"/>	<input checked="" type="checkbox"/>
0.2	CCGT-060202-ENP-KX	<input checked="" type="checkbox"/>	<input checked="" type="checkbox"/>	<input checked="" type="checkbox"/>
0.4	CCGT-060204-ENP-KX	<input checked="" type="checkbox"/>	<input checked="" type="checkbox"/>	<input checked="" type="checkbox"/>
0.1	CCGT-09T301-ENP-KX	<input checked="" type="checkbox"/>	<input checked="" type="checkbox"/>	<input checked="" type="checkbox"/>
0.2	CCGT-09T302-ENP-KX	<input checked="" type="checkbox"/>	<input checked="" type="checkbox"/>	<input checked="" type="checkbox"/>
0.4	CCGT-09T304-ENP-KX	<input checked="" type="checkbox"/>	<input checked="" type="checkbox"/>	<input checked="" type="checkbox"/>



Plaquettes CERMET

CERMET-Wendeplatten

CERMET inserts

80°

CCMT-KM

CCMT
EN-KM

		CERMET		
		PVD		non revêtu unbeschichtet uncoated
		P	P	P
		M	M	
		CT7	HCT7	CN6
R	Art. N°			
0.2	CCMT-060202-EN-KM	■	■	■
0.4	CCMT-060204-EN-KM	■	■	■
0.2	CCMT-09T302-EN-KM	■	■	■
0.4	CCMT-09T304-EN-KM	■	■	■
0.8	CCMT-09T308-EN-KM	■	■	■



ISO-LINE

Outils de tournage 55°

55°-Drehwerkzeuge

Turning tools 55°

55°

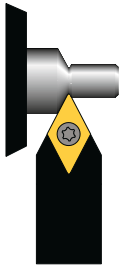

SDN



SDA



SDJ



SDH

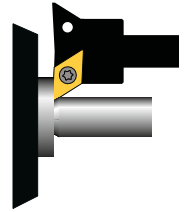

SDU

Porte-outils

Halter

Holder

55°

SDN

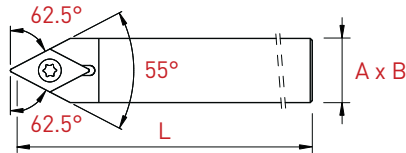

Plaquettes WSP Inserts	A x B x L	Art. N°
DC...0702..	8 x 8 x 115	SDNCN-0808X-07
	10 x 10 x 115	SDNCN-1010X-07
	12 x 12 x 130	SDNCN-1212X-07
	12 x 12 x 90	SDNCN-1212G-07
	12.7 x 12.7 x 130	SDNCN-12.7-X-07
	16 x 16 x 130	SDNCN-1616X-07
	16 x 16 x 75	SDNCN-1616F-07
DC...11T3..	12 x 12 x 130	SDNCN-1212X-11
	12 x 12 x 90	SDNCN-1212G-11
	12.7 x 12.7 x 130	SDNCN-12.7-X-11
	16 x 16 x 130	SDNCN-1616X-11
	16 x 16 x 75	SDNCN-1616F-11
	20 x 20 x 120	SDNCN-2020X-11

Porte-outils

Halter

Holders

55°

SDA

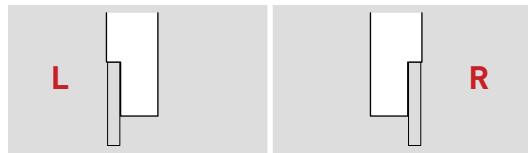
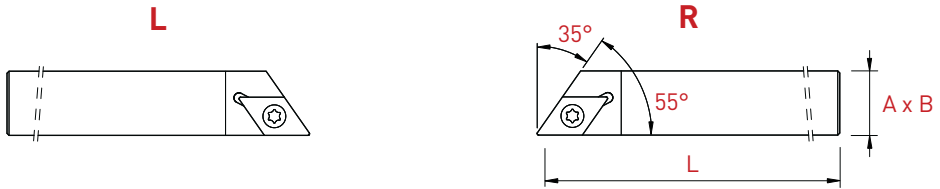

Plaquettes WSP Inserts	A x B x L	Art. N°	Art. N°
DC..-0702..	8 x 8 x 115	SDACL-0808X-07	SDACR-0808X-07
	10 x 10 x 115	SDACL-1010X-07	SDACR-1010X-07
	12 x 12 x 130	SDACL-1212X-07	SDACR-1212X-07
	12 x 12 x 90	SDACL-1212G-07	SDACR-1212G-07
	12.7 x 12.7 x 130	SDACL-12.7-X-07	SDACR-12.7-X-07
	16 x 16 x 130	SDACL-1616X-07	SDACR-1616X-07
	16 x 16 x 75	SDACL-1616F-07	SDACR-1616F-07
DC..-11T3..	12 x 12 x 130	SDACL-1212X-11	SDACR-1212X-11
	12 x 12 x 90	SDACL-1212G-11	SDACR-1212G-11
	12.7 x 12.7 x 130	SDACL-12.7-X-11	SDACR-12.7-X-11
	16 x 16 x 130	SDACL-1616X-11	SDACR-1616X-11
	16 x 16 x 75	SDACL-1616F-11	SDACR-1616F-11
	20 x 20 x 120	SDACL-2020X-11	SDACR-2020X-11

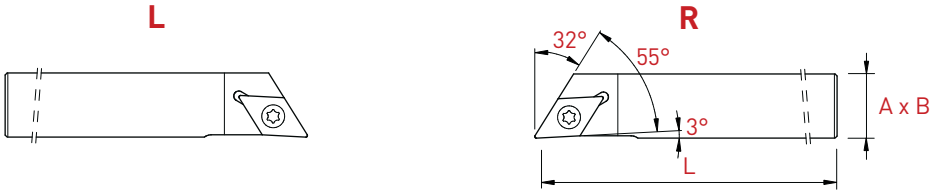

Plaquettes WSP Inserts	A x B x L	Art. N°	Art. N°
DC...0702..	8 x 8 x 115	SDJCL-0808X-07	SDJCR-0808X-07
	10 x 10 x 115	SDJCL-1010X-07	SDJCR-1010X-07
	12 x 12 x 130	SDJCL-1212X-07	SDJCR-1212X-07
	12 x 12 x 90	SDJCL-1212G-07	SDJCR-1212G-07
	12.7 x 12.7 x 130	SDJCL-12.7-X-07	SDJCR-12.7-X-07
	16 x 16 x 130	SDJCL-1616X-07	SDJCR-1616X-07
	16 x 16 x 75	SDJCL-1616F-07	SDJCR-1616F-07
	20 x 20 x 120	SDJCL-2020X-07	SDJCR-2020X-07
DC...11T3..	12 x 12 x 130	SDJCL-1212X-11	SDJCR-1212X-11
	12 x 12 x 90	SDJCL-1212G-11	SDJCR-1212G-11
	12.7 x 12.7 x 130	SDJCL-12.7-X-11	SDJCR-12.7-X-11
	16 x 16 x 130	SDJCL-1616X-11	SDJCR-1616X-11
	16 x 16 x 75	SDJCL-1616F-11	SDJCR-1616F-11
	20 x 20 x 120	SDJCL-2020X-11	SDJCR-2020X-11

Porte-outils avec arrosage intégré
 Halter mit integrierter Kühlmittelzufuhr
 Holders with integrated coolant supply

55°

SDJ-JET

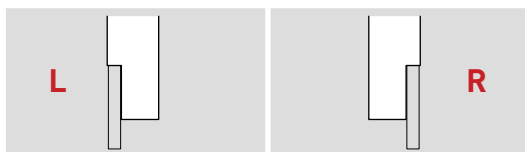
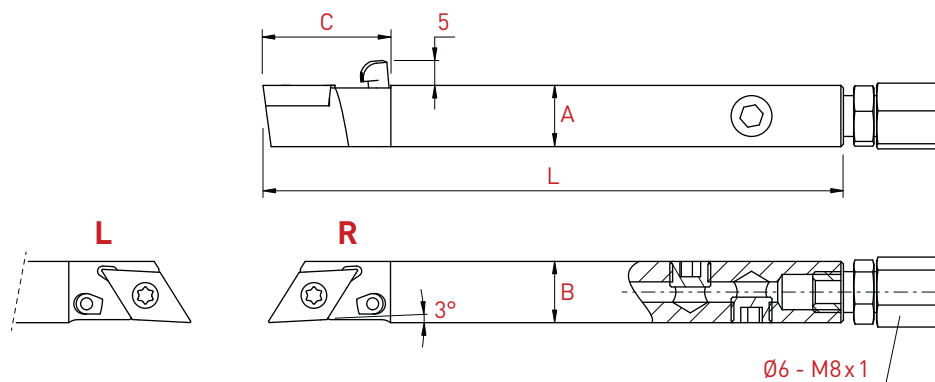

Plaquettes WSP Inserts	A x B x L	C	Art. N°	Art. N°
DC...-0702..	10 x 10 x 110	20	SDJCL-1010J-07-JET	SDJCR-1010J-07-JET
	12 x 12 x 110	20	SDJCL-1212J-07-JET	SDJCR-1212J-07-JET
	12.7 x 12.7 x 110	20	SDJCL-12.7-J-07-JET	SDJCR-12.7-J-07-JET
	16 x 16 x 110	20	SDJCL-1616J-07-JET	SDJCR-1616J-07-JET
	20 x 20 x 110	20	SDJCL-2020J-07-JET	SDJCR-2020J-07-JET
DC...-11T3..	12 x 12 x 110	23	SDJCL-1212J-11-JET	SDJCR-1212J-11-JET
	12.7 x 12.7 x 110	23	SDJCL-12.7-J-11-JET	SDJCR-12.7-J-11-JET
	16 x 16 x 110	23	SDJCL-1616J-11-JET	SDJCR-1616J-11-JET
	20 x 20 x 110	23	SDJCL-2020J-11-JET	SDJCR-2020J-11-JET

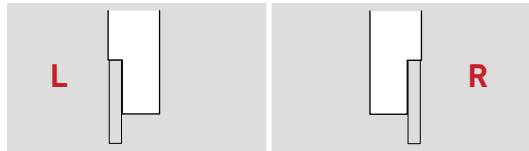
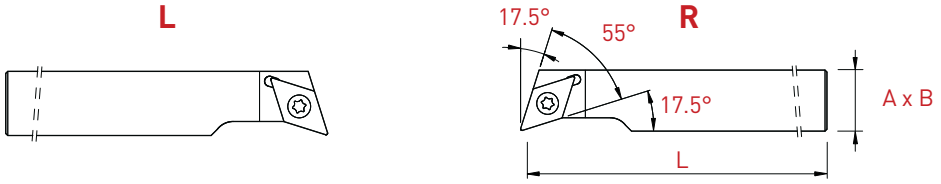

Plaquettes WSP Inserts	A x B x L	Art. N°	Art. N°
DC...0702..	10 x 10 x 115	SDHCL-1010X-07	SDHCR-1010X-07
	12 x 12 x 130	SDHCL-1212X-07	SDHCR-1212X-07
	12 x 12 x 90	SDHCL-1212G-07	SDHCR-1212G-07
	12.7 x 12.7 x 130	SDHCL-12.7-X-07	SDHCR-12.7-X-07
	16 x 16 x 130	SDHCL-1616X-07	SDHCR-1616X-07
	16 x 16 x 75	SDHCL-1616F-07	SDHCR-1616F-07
DC...11T3..	16 x 16 x 130	SDHCL-1616X-11	SDHCR-1616X-11
	16 x 16 x 75	SDHCL-1616F-11	SDHCR-1616F-11
	20 x 20 x 120	SDHCL-2020X-11	SDHCR-2020X-11

Porte-outils

Halter

Holders

55°

SDU

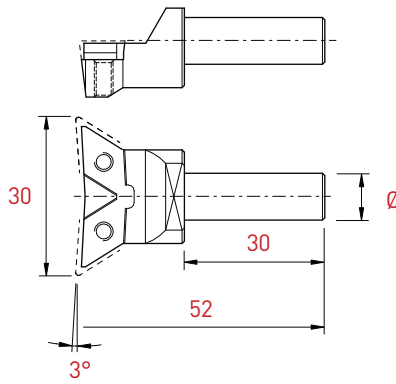

Plaquettes WSP Inserts	Ø	Art. N°
DC..-11T3..	10	SDUC-D10X-11

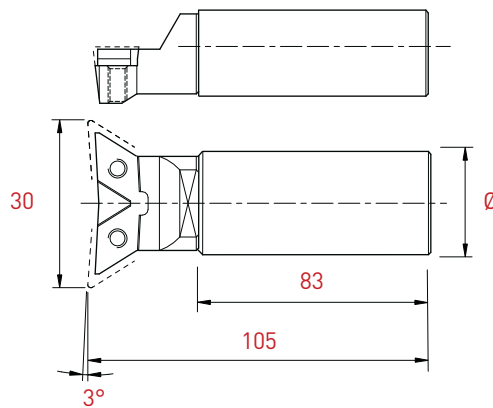

Plaquettes WSP Inserts	Ø	Art. N°
DC..-11T3..	20	SDUC-D20X-11
	25.4	SDUC-D25.4X-11



DCGT-FN-X8

PVD			non revêtu unbeschichtet uncoated	
TiAlN	HTA	TiN	K10	K20
<input type="checkbox"/>	<input type="checkbox"/>	<input type="checkbox"/>	<input type="checkbox"/>	<input type="checkbox"/>
<input type="checkbox"/>	<input type="checkbox"/>	<input type="checkbox"/>	<input type="checkbox"/>	<input type="checkbox"/>
<input type="checkbox"/>	<input type="checkbox"/>	<input type="checkbox"/>	<input type="checkbox"/>	<input type="checkbox"/>
<input type="checkbox"/>	<input type="checkbox"/>	<input type="checkbox"/>	<input type="checkbox"/>	<input type="checkbox"/>
<input type="checkbox"/>	<input type="checkbox"/>	<input type="checkbox"/>	<input type="checkbox"/>	<input type="checkbox"/>

R	Art. N°	TiAlN	HTA	TiN	K10	K20
0.05	DCGT-0702005-FN-X8	<input checked="" type="checkbox"/>	<input checked="" type="checkbox"/>	<input checked="" type="checkbox"/>	<input checked="" type="checkbox"/>	<input checked="" type="checkbox"/>
0.08	DCGT-0702008-FN-X8	<input checked="" type="checkbox"/>	<input checked="" type="checkbox"/>	<input checked="" type="checkbox"/>	<input checked="" type="checkbox"/>	<input checked="" type="checkbox"/>
0.1	DCGT-070201-FN-X8	<input checked="" type="checkbox"/>	<input checked="" type="checkbox"/>	<input checked="" type="checkbox"/>	<input checked="" type="checkbox"/>	<input checked="" type="checkbox"/>
0,15	DCGT-0702015-FN-X8	<input checked="" type="checkbox"/>	<input checked="" type="checkbox"/>	<input checked="" type="checkbox"/>	<input checked="" type="checkbox"/>	<input checked="" type="checkbox"/>
0.2	DCGT-070202-FN-X8	<input checked="" type="checkbox"/>	<input checked="" type="checkbox"/>	<input checked="" type="checkbox"/>	<input checked="" type="checkbox"/>	<input checked="" type="checkbox"/>
0.4	DCGT-070204-FN-X8	<input checked="" type="checkbox"/>	<input checked="" type="checkbox"/>	<input checked="" type="checkbox"/>	<input checked="" type="checkbox"/>	<input checked="" type="checkbox"/>
0.05	DCGT-11T3005-FN-X8	<input checked="" type="checkbox"/>	<input checked="" type="checkbox"/>	<input checked="" type="checkbox"/>	<input checked="" type="checkbox"/>	<input checked="" type="checkbox"/>
0,08	DCGT-11T3008-FN-X8	<input checked="" type="checkbox"/>	<input checked="" type="checkbox"/>	<input checked="" type="checkbox"/>	<input checked="" type="checkbox"/>	<input checked="" type="checkbox"/>
0.1	DCGT-11T301-FN-X8	<input checked="" type="checkbox"/>	<input checked="" type="checkbox"/>	<input checked="" type="checkbox"/>	<input checked="" type="checkbox"/>	<input checked="" type="checkbox"/>
0,15	DCGT-11T3015-FN-X8	<input checked="" type="checkbox"/>	<input checked="" type="checkbox"/>	<input checked="" type="checkbox"/>	<input checked="" type="checkbox"/>	<input checked="" type="checkbox"/>
0.2	DCGT-11T302-FN-X8	<input checked="" type="checkbox"/>	<input checked="" type="checkbox"/>	<input checked="" type="checkbox"/>	<input checked="" type="checkbox"/>	<input checked="" type="checkbox"/>
0.4	DCGT-11T304-FN-X8	<input checked="" type="checkbox"/>	<input checked="" type="checkbox"/>	<input checked="" type="checkbox"/>	<input checked="" type="checkbox"/>	<input checked="" type="checkbox"/>

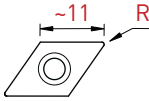
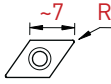

DCGT-ENP-X8

PVD		non revêtu unbeschichtet uncoated
TiAlN	TiN	K20
<input type="checkbox"/>	<input type="checkbox"/>	<input type="checkbox"/>
<input type="checkbox"/>	<input type="checkbox"/>	<input type="checkbox"/>
<input type="checkbox"/>	<input type="checkbox"/>	<input type="checkbox"/>
<input type="checkbox"/>	<input type="checkbox"/>	<input type="checkbox"/>
<input type="checkbox"/>	<input type="checkbox"/>	<input type="checkbox"/>

R	Art. N°	TiAlN	TiN	K20
0.05	DCGT-0702005-ENP-X8	<input checked="" type="checkbox"/>	<input checked="" type="checkbox"/>	<input checked="" type="checkbox"/>
0,08	DCGT-0702008-ENP-X8	<input checked="" type="checkbox"/>	<input checked="" type="checkbox"/>	<input checked="" type="checkbox"/>
0.1	DCGT-070201-ENP-X8	<input checked="" type="checkbox"/>	<input checked="" type="checkbox"/>	<input checked="" type="checkbox"/>
0,15	DCGT-0702015-ENP-X8	<input checked="" type="checkbox"/>	<input checked="" type="checkbox"/>	<input checked="" type="checkbox"/>
0.2	DCGT-070202-ENP-X8	<input checked="" type="checkbox"/>	<input checked="" type="checkbox"/>	<input checked="" type="checkbox"/>
0.4	DCGT-070204-ENP-X8	<input checked="" type="checkbox"/>	<input checked="" type="checkbox"/>	<input checked="" type="checkbox"/>
0.05	DCGT-11T3005-ENP-X8	<input checked="" type="checkbox"/>	<input checked="" type="checkbox"/>	<input checked="" type="checkbox"/>
0,08	DCGT-11T3008-ENP-X8	<input checked="" type="checkbox"/>	<input checked="" type="checkbox"/>	<input checked="" type="checkbox"/>
0.1	DCGT-11T301-ENP-X8	<input checked="" type="checkbox"/>	<input checked="" type="checkbox"/>	<input checked="" type="checkbox"/>
0,15	DCGT-11T3015-ENP-X8	<input checked="" type="checkbox"/>	<input checked="" type="checkbox"/>	<input checked="" type="checkbox"/>
0.2	DCGT-11T302-ENP-X8	<input checked="" type="checkbox"/>	<input checked="" type="checkbox"/>	<input checked="" type="checkbox"/>
0.4	DCGT-11T304-ENP-X8	<input checked="" type="checkbox"/>	<input checked="" type="checkbox"/>	<input checked="" type="checkbox"/>

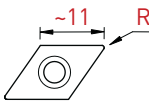
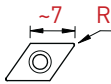

Plaquettes en métal dur

VHM-Wendeplatten

Solid carbide inserts

55°

DCGT-X17



DCGT
FN-X17

R	Art. N°	PVD			non revêtu unbeschichtet uncoated	
		TiAlN	HTA	TiN	K10	K20
0.05	DCGT-0702005-FN-X17	<input checked="" type="checkbox"/>	<input checked="" type="checkbox"/>	<input checked="" type="checkbox"/>	<input type="checkbox"/>	<input type="checkbox"/>
0.08	DCGT-0702008-FN-X17	<input checked="" type="checkbox"/>	<input checked="" type="checkbox"/>	<input checked="" type="checkbox"/>	<input type="checkbox"/>	<input type="checkbox"/>
0.1	DCGT-070201-FN-X17	<input checked="" type="checkbox"/>	<input checked="" type="checkbox"/>	<input checked="" type="checkbox"/>	<input type="checkbox"/>	<input type="checkbox"/>
0.15	DCGT-0702015-FN-X17	<input checked="" type="checkbox"/>	<input checked="" type="checkbox"/>	<input checked="" type="checkbox"/>	<input type="checkbox"/>	<input type="checkbox"/>
0.2	DCGT-070202-FN-X17	<input checked="" type="checkbox"/>	<input checked="" type="checkbox"/>	<input checked="" type="checkbox"/>	<input type="checkbox"/>	<input type="checkbox"/>
0.4	DCGT-070204-FN-X17	<input checked="" type="checkbox"/>	<input checked="" type="checkbox"/>	<input checked="" type="checkbox"/>	<input type="checkbox"/>	<input type="checkbox"/>
0.05	DCGT-11T3005-FN-X17	<input checked="" type="checkbox"/>	<input checked="" type="checkbox"/>	<input checked="" type="checkbox"/>	<input type="checkbox"/>	<input type="checkbox"/>
0.08	DCGT-11T3008-FN-X17	<input checked="" type="checkbox"/>	<input checked="" type="checkbox"/>	<input checked="" type="checkbox"/>	<input type="checkbox"/>	<input type="checkbox"/>
0.1	DCGT-11T301-FN-X17	<input checked="" type="checkbox"/>	<input checked="" type="checkbox"/>	<input checked="" type="checkbox"/>	<input type="checkbox"/>	<input type="checkbox"/>
0.15	DCGT-11T3015-FN-X17	<input checked="" type="checkbox"/>	<input checked="" type="checkbox"/>	<input checked="" type="checkbox"/>	<input type="checkbox"/>	<input type="checkbox"/>
0.2	DCGT-11T302-FN-X17	<input checked="" type="checkbox"/>	<input checked="" type="checkbox"/>	<input checked="" type="checkbox"/>	<input type="checkbox"/>	<input type="checkbox"/>
0.4	DCGT-11T304-FN-X17	<input checked="" type="checkbox"/>	<input checked="" type="checkbox"/>	<input checked="" type="checkbox"/>	<input type="checkbox"/>	<input type="checkbox"/>
0.8	DCGT-11T308-FN-X17	<input checked="" type="checkbox"/>	<input checked="" type="checkbox"/>	<input checked="" type="checkbox"/>	<input type="checkbox"/>	<input type="checkbox"/>

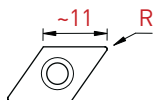
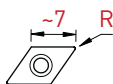

DCGT
ENP-X17

R	Art. N°	PVD		non revêtu unbeschichtet uncoated
		TiAlN	TiN	K20
0.05	DCGT-0702005-ENP-X17	<input checked="" type="checkbox"/>	<input checked="" type="checkbox"/>	<input type="checkbox"/>
0.08	DCGT-0702008-ENP-X17	<input checked="" type="checkbox"/>	<input checked="" type="checkbox"/>	<input type="checkbox"/>
0.1	DCGT-070201-ENP-X17	<input checked="" type="checkbox"/>	<input checked="" type="checkbox"/>	<input type="checkbox"/>
0.15	DCGT-0702015-ENP-X17	<input checked="" type="checkbox"/>	<input checked="" type="checkbox"/>	<input type="checkbox"/>
0.2	DCGT-070202-ENP-X17	<input checked="" type="checkbox"/>	<input checked="" type="checkbox"/>	<input type="checkbox"/>
0.4	DCGT-070204-ENP-X17	<input checked="" type="checkbox"/>	<input checked="" type="checkbox"/>	<input type="checkbox"/>
0.05	DCGT-11T3005-ENP-X17	<input checked="" type="checkbox"/>	<input checked="" type="checkbox"/>	<input type="checkbox"/>
0.08	DCGT-11T3008-ENP-X17	<input checked="" type="checkbox"/>	<input checked="" type="checkbox"/>	<input type="checkbox"/>
0.1	DCGT-11T301-ENP-X17	<input checked="" type="checkbox"/>	<input checked="" type="checkbox"/>	<input type="checkbox"/>
0.15	DCGT-11T3015-ENP-X17	<input checked="" type="checkbox"/>	<input checked="" type="checkbox"/>	<input type="checkbox"/>
0.2	DCGT-11T302-ENP-X17	<input checked="" type="checkbox"/>	<input checked="" type="checkbox"/>	<input type="checkbox"/>
0.4	DCGT-11T304-ENP-X17	<input checked="" type="checkbox"/>	<input checked="" type="checkbox"/>	<input type="checkbox"/>
0.8	DCGT-11T308-ENP-X17	<input checked="" type="checkbox"/>	<input checked="" type="checkbox"/>	<input type="checkbox"/>

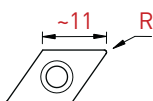
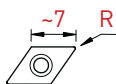



DCGT
FN-X25

R	Art. N°	PVD			non revêtu unbeschichtet uncoated	
		TiAlN	HTA	TiN	K10	K20
		<input type="checkbox"/> P <input type="checkbox"/> M <input type="checkbox"/> N <input type="checkbox"/> S	<input type="checkbox"/> P <input type="checkbox"/> M <input type="checkbox"/> N <input type="checkbox"/> S	<input type="checkbox"/> P <input type="checkbox"/> M <input type="checkbox"/> N	<input type="checkbox"/>	<input type="checkbox"/> N
0.05	DCGT-0702005-FN-X25	<input checked="" type="checkbox"/>	<input checked="" type="checkbox"/>	<input checked="" type="checkbox"/>	<input checked="" type="checkbox"/>	<input checked="" type="checkbox"/>
0.1	DCGT-070201-FN-X25	<input checked="" type="checkbox"/>	<input checked="" type="checkbox"/>	<input checked="" type="checkbox"/>	<input checked="" type="checkbox"/>	<input checked="" type="checkbox"/>
0.2	DCGT-070202-FN-X25	<input checked="" type="checkbox"/>	<input checked="" type="checkbox"/>	<input checked="" type="checkbox"/>	<input checked="" type="checkbox"/>	<input checked="" type="checkbox"/>
0.4	DCGT-070204-FN-X25	<input checked="" type="checkbox"/>	<input checked="" type="checkbox"/>	<input checked="" type="checkbox"/>	<input checked="" type="checkbox"/>	<input checked="" type="checkbox"/>
0.05	DCGT-11T3005-FN-X25	<input checked="" type="checkbox"/>	<input checked="" type="checkbox"/>	<input checked="" type="checkbox"/>	<input checked="" type="checkbox"/>	<input checked="" type="checkbox"/>
0.1	DCGT-11T301-FN-X25	<input checked="" type="checkbox"/>	<input checked="" type="checkbox"/>	<input checked="" type="checkbox"/>	<input checked="" type="checkbox"/>	<input checked="" type="checkbox"/>
0.2	DCGT-11T302-FN-X25	<input checked="" type="checkbox"/>	<input checked="" type="checkbox"/>	<input checked="" type="checkbox"/>	<input checked="" type="checkbox"/>	<input checked="" type="checkbox"/>
0.4	DCGT-11T304-FN-X25	<input checked="" type="checkbox"/>	<input checked="" type="checkbox"/>	<input checked="" type="checkbox"/>	<input checked="" type="checkbox"/>	<input checked="" type="checkbox"/>
0.8	DCGT-11T308-FN-X25	<input checked="" type="checkbox"/>	<input checked="" type="checkbox"/>	<input checked="" type="checkbox"/>	<input checked="" type="checkbox"/>	<input checked="" type="checkbox"/>

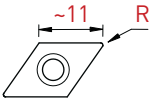
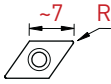

DCGT
ENP-X25

R	Art. N°	PVD		non revêtu unbeschichtet uncoated
		TiAlN	TiN	K20
		<input type="checkbox"/> P <input type="checkbox"/> M <input type="checkbox"/> N <input type="checkbox"/> S	<input type="checkbox"/> P <input type="checkbox"/> M <input type="checkbox"/> N	<input type="checkbox"/> N
0.05	DCGT-0702005-ENP-X25	<input checked="" type="checkbox"/>	<input checked="" type="checkbox"/>	<input checked="" type="checkbox"/>
0.1	DCGT-070201-ENP-X25	<input checked="" type="checkbox"/>	<input checked="" type="checkbox"/>	<input checked="" type="checkbox"/>
0.2	DCGT-070202-ENP-X25	<input checked="" type="checkbox"/>	<input checked="" type="checkbox"/>	<input checked="" type="checkbox"/>
0.4	DCGT-070204-ENP-X25	<input checked="" type="checkbox"/>	<input checked="" type="checkbox"/>	<input checked="" type="checkbox"/>
0.05	DCGT-11T3005-ENP-X25	<input checked="" type="checkbox"/>	<input checked="" type="checkbox"/>	<input checked="" type="checkbox"/>
0.1	DCGT-11T301-ENP-X25	<input checked="" type="checkbox"/>	<input checked="" type="checkbox"/>	<input checked="" type="checkbox"/>
0.2	DCGT-11T302-ENP-X25	<input checked="" type="checkbox"/>	<input checked="" type="checkbox"/>	<input checked="" type="checkbox"/>
0.4	DCGT-11T304-ENP-X25	<input checked="" type="checkbox"/>	<input checked="" type="checkbox"/>	<input checked="" type="checkbox"/>
0.8	DCGT-11T308-ENP-X25	<input checked="" type="checkbox"/>	<input checked="" type="checkbox"/>	<input checked="" type="checkbox"/>

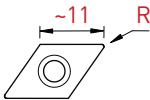
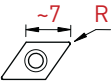

Plaquettes en métal dur

VHM-Wendeplatten

Solid carbide inserts

55°

DCGT-X20



DCGT
ENP-X20

PVD



R	Art. N°	ZTA	HTIX
0.1	DCGT-070201-ENP-X20	■	
0.2	DCGT-070202-ENP-X20	■	■
0.4	DCGT-070204-ENP-X20	■	■
0.1	DCGT-11T301-ENP-X20	■	
0.2	DCGT-11T302-ENP-X20	■	■
0.4	DCGT-11T304-ENP-X20	■	■
0.8	DCGT-11T308-ENP-X20	■	■

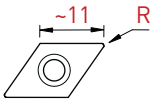
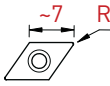

ISO-LINE

Plaquettes en métal dur
VHM-Wendplatten
Solid carbide inserts

55°

DCMT-XF3
DCMT-XF2
DCMT-MF2

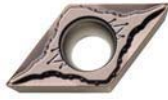

DCMT
EN-XF3

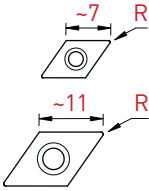

R	Art. N°	PVD	
		TAC	HTAC
0.2	DCMT-070202-EN-XF3	<input checked="" type="checkbox"/>	<input checked="" type="checkbox"/>
0.4	DCMT-070204-EN-XF3	<input checked="" type="checkbox"/>	<input checked="" type="checkbox"/>
0.2	DCMT-11T302-EN-XF3	<input checked="" type="checkbox"/>	<input checked="" type="checkbox"/>
0.4	DCMT-11T304-EN-XF3	<input checked="" type="checkbox"/>	<input checked="" type="checkbox"/>

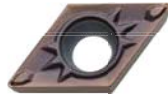

DCMT
EN-XF2

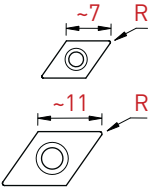

R	Art. N°	PVD		CVD
		TAC	HTAC	HT15
0.2	DCMT-070202-EN-XF2	<input checked="" type="checkbox"/>	<input checked="" type="checkbox"/>	<input checked="" type="checkbox"/>
0.4	DCMT-070204-EN-XF2	<input checked="" type="checkbox"/>	<input checked="" type="checkbox"/>	<input checked="" type="checkbox"/>
0.2	DCMT-11T302-EN-XF2	<input checked="" type="checkbox"/>	<input checked="" type="checkbox"/>	<input checked="" type="checkbox"/>
0.4	DCMT-11T304-EN-XF2	<input checked="" type="checkbox"/>	<input checked="" type="checkbox"/>	<input checked="" type="checkbox"/>



DCMT
EN-MF2

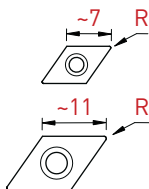

R	Art. N°	PVD		CVD	
		TAC	HTAC	Ti5	HT15
0.2	DCMT-070202-EN-MF2	<input checked="" type="checkbox"/>	<input checked="" type="checkbox"/>	<input checked="" type="checkbox"/>	<input checked="" type="checkbox"/>
0.4	DCMT-070204-EN-MF2	<input checked="" type="checkbox"/>	<input checked="" type="checkbox"/>	<input checked="" type="checkbox"/>	<input checked="" type="checkbox"/>
0.2	DCMT-11T302-EN-MF2	<input checked="" type="checkbox"/>	<input checked="" type="checkbox"/>	<input checked="" type="checkbox"/>	<input checked="" type="checkbox"/>
0.4	DCMT-11T304-EN-MF2	<input checked="" type="checkbox"/>	<input checked="" type="checkbox"/>	<input checked="" type="checkbox"/>	<input checked="" type="checkbox"/>
0.8	DCMT-11T308-EN-MF2	<input checked="" type="checkbox"/>	<input checked="" type="checkbox"/>	<input checked="" type="checkbox"/>	<input checked="" type="checkbox"/>

Plaquettes en métal dur

VHM-Wendepplatten

Solid carbide inserts

55°

DCMT-MF

DCMT-HF3

DCMT-HF

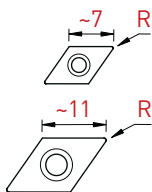

DCMT
EN-MF

R	Art. N°	PVD		CVD	
		Tmax	Ti4	Tmax	Ti4
0.2	DCMT-070202-EN-MF	■	■	■	■
0.4	DCMT-070204-EN-MF	■	■	■	■
0.2	DCMT-11T302-EN-MF	■	■	■	■
0.4	DCMT-11T304-EN-MF	■	■	■	■

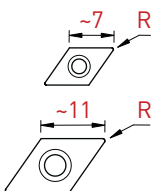

DCMT
EN-HF3

R	Art. N°	PVD		CVD	
		TiX	HTiX	Ti6	
0,2	DCMT-070202-EN-HF3	■	■	■	
0.4	DCMT-070204-EN-HF3	■	■	■	
0,2	DCMT-11T302-EN-HF3	■	■	■	
0.4	DCMT-11T304-EN-HF3	■	■	■	
0.8	DCMT-11T308-EN-HF3	■	■	■	

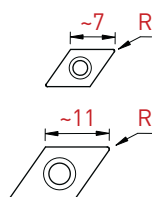

DCMT
EN-HF

R	Art. N°	PVD			CVD		
		Tmax	TAC	Ti4	Ti5	HTi5	
0,2	DCMT-070202-EN-HF	■	■	■	■	■	
0.4	DCMT-070204-EN-HF	■	■	■	■	■	
0.8	DCMT-070208-EN-HF	■	■	■	■	■	
0,2	DCMT-11T302-EN-HF	■	■	■	■	■	
0.4	DCMT-11T304-EN-HF	■	■	■	■	■	
0.8	DCMT-11T308-EN-HF	■	■	■	■	■	



**DCGT
FN-X8**

		CERMET	
		PVD	non revêtu unbeschichtet uncoated
		<input type="checkbox"/> P <input checked="" type="checkbox"/> M <input type="checkbox"/>	<input type="checkbox"/> P <input type="checkbox"/>
		CTA	CN6
R	Art. N°	<input type="checkbox"/>	<input type="checkbox"/>
0.05	DCGT-0702005-FN-X8	<input checked="" type="checkbox"/>	<input checked="" type="checkbox"/>
0.1	DCGT-070201-FN-X8	<input checked="" type="checkbox"/>	<input checked="" type="checkbox"/>
0.2	DCGT-070202-FN-X8	<input checked="" type="checkbox"/>	<input checked="" type="checkbox"/>
0.05	DCGT-11T3005-FN-X8	<input checked="" type="checkbox"/>	<input checked="" type="checkbox"/>
0.1	DCGT-11T301-FN-X8	<input checked="" type="checkbox"/>	<input checked="" type="checkbox"/>
0.2	DCGT-11T302-FN-X8	<input checked="" type="checkbox"/>	<input checked="" type="checkbox"/>
0.4	DCGT-11T304-FN-X8	<input checked="" type="checkbox"/>	<input checked="" type="checkbox"/>

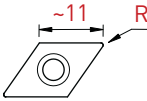
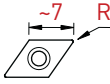

**DCGT
ENP-KX**

		CERMET	
		PVD	non revêtu unbeschichtet uncoated
		<input checked="" type="checkbox"/> P <input checked="" type="checkbox"/> M <input type="checkbox"/>	<input checked="" type="checkbox"/> P <input type="checkbox"/>
		CT7	HCT7
R	Art. N°	<input type="checkbox"/>	<input type="checkbox"/>
0.1	DCGT-070201-ENP-KX	<input checked="" type="checkbox"/>	<input checked="" type="checkbox"/>
0.2	DCGT-070202-ENP-KX	<input checked="" type="checkbox"/>	<input checked="" type="checkbox"/>
0.4	DCGT-070204-ENP-KX	<input checked="" type="checkbox"/>	<input checked="" type="checkbox"/>
0.1	DCGT-11T301-ENP-KX	<input checked="" type="checkbox"/>	<input checked="" type="checkbox"/>
0.2	DCGT-11T302-ENP-KX	<input checked="" type="checkbox"/>	<input checked="" type="checkbox"/>
0.4	DCGT-11T304-ENP-KX	<input checked="" type="checkbox"/>	<input checked="" type="checkbox"/>

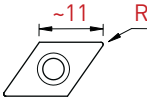
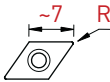

Plaquettes CERMET
 CERMET-Wendeplatten
 CERMET inserts

55°

DCMT-KM

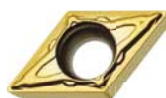

DCMT
 EN-KM

		CERMET		
		PVD		non revêtu unbeschichtet uncoated
		P M	P M	P
		<input type="checkbox"/>	<input type="checkbox"/>	<input type="checkbox"/>
		<input type="checkbox"/>	<input type="checkbox"/>	<input type="checkbox"/>
		CT7	HCT7	CN6
R	Art. N°			
0.2	DCMT-070202-EN-KM	■	■	■
0.4	DCMT-070204-EN-KM	■	■	■
0.2	DCMT-11T302-EN-KM	■	■	■
0.4	DCMT-11T304-EN-KM	■	■	■
0.8	DCMT-11T308-EN-KM	■	■	■

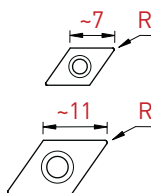

ISO-LINE

Outils de tournage 35°

35°-Drehwerkzeuge

Turning tools 35°

35°

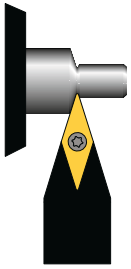

SVV



SVA



SVJ



SVX

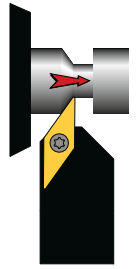

SV-CL/R

Porte-outils

Halter

Holder

35°

SVV

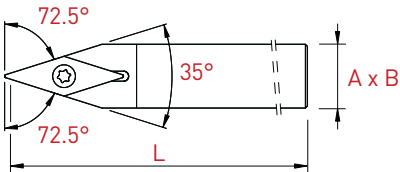

Plaquettes WSP Inserts	A x B x L	Art. N°
VC...-1103..	8 x 8 x 115	SVVCN-08108X-11
	10 x 10 x 115	SVVCN-1010X-11
	12 x 12 x 130	SVVCN-1212X-11
	12 x 12 x 90	SVVCN-1212G-11
	12.7 x 12.7 x 130	SVVCN-12.7-X-11
	16 x 16 x 130	SVVCN-1616X-11
	16 x 16 x 75	SVVCN-1616F-11
VC...-1303..	20 x 20 x 120	SVVCN-2020X-11
	8 x 10 x 115	SVVCN-0810X-13
	10 x 10 x 115	SVVCN-1010X-13
	12 x 12 x 130	SVVCN-1212X-13
	12 x 12 x 90	SVVCN-1212G-13
	12.7 x 12.7 x 130	SVVCN-12.7-X-13
	16 x 16 x 130	SVVCN-1616X-13
	16 x 16 x 75	SVVCN-1616F-13
20 x 20 x 120	SVVCN-2020X-13	
VC...-1604..	12 x 12 x 130	SVVCN-1212X-16
	12 x 12 x 90	SVVCN-1212G-16
	12.7 x 12.7 x 130	SVVCN-12.7-X-16
	16 x 16 x 130	SVVCN-1616X-16
	16 x 16 x 75	SVVCN-1616F-16
	20 x 20 x 120	SVVCN-2020X-16

Porte-outils

Halter

Holders

35°

SVA

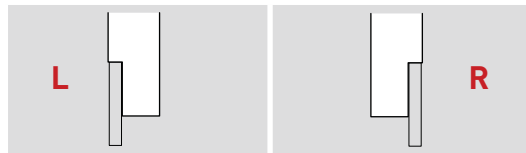
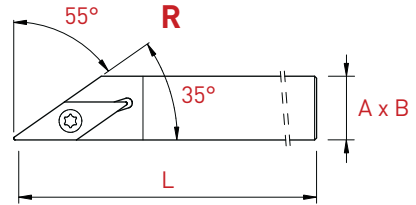
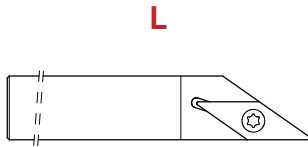

Plaquettes WSP Inserts	A x B x L	Art. N°	Art. N°
VC...1103..	8 x 8 x 115	SVACL-0808X-11	SVACR-0808X-11
	10 x 10 x 115	SVACL-1010X-11	SVACR-1010X-11
	12 x 12 x 130	SVACL-1212X-11	SVACR-1212X-11
	12 x 12 x 90	SVACL-1212G-11	SVACR-1212G-11
	12.7 x 12.7 x 130	SVACL-12.7-X-11	SVACR-12.7-X-11
	16 x 16 x 130	SVACL-1616X-11	SVACR-1616X-11
	16 x 16 x 75	SVACL-1616F-11	SVACR-1616F-11
	20 x 20 x 120	SVACL-2020X-11	SVACR-2020X-11
VC...1604..	12 x 12 x 130	SVACL-1212X-16	SVACR-1212X-16
	12 x 12 x 90	SVACL-1212G-16	SVACR-1212G-16
	12.7 x 12.7 x 130	SVACL-12.7-X-16	SVACR-12.7-X-16
	16 x 16 x 130	SVACL-1616X-16	SVACR-1616X-16
	16 x 16 x 75	SVACL-1616F-16	SVACR-1616F-16
	20 x 20 x 120	SVACL-2020X-16	SVACR-2020X-16

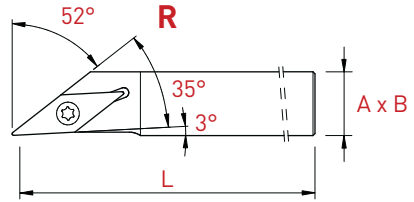
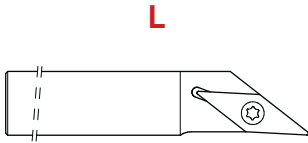

Plaquettes WSP Inserts	A x B x L	Art. N°	Art. N°
VC..-1103..	8 x 8 x 115	SVJCL-0808X-11	SVJCR-0808X-11
	10 x 10 x 115	SVJCL-1010X-11	SVJCR-1010X-11
	12 x 12 x 130	SVJCL-1212X-11	SVJCR-1212X-11
	12 x 12 x 90	SVJCL-1212G-11	SVJCR-1212G-11
	12.7 x 12.7 x 130	SVJCL-12.7-X-11	SVJCR-12.7-X-11
	16 x 16 x 130	SVJCL-1616X-11	SVJCR-1616X-11
	16 x 16 x 75	SVJCL-1616F-11	SVJCR-1616F-11
20 x 20 x 120	SVJCL-2020X-11	SVJCR-2020X-11	
VC..-1303..	8 x 10 x 115	SVJCL-0810X-13	SVJCR-0810X-13
	10 x 10 x 115	SVJCL-1010X-13	SVJCR-1010X-13
	12 x 12 x 130	SVJCL-1212X-13	SVJCR-1212X-13
	12 x 12 x 90	SVJCL-1212G-13	SVJCR-1212G-13
	12.7 x 12.7 x 130	SVJCL-12.7-X-13	SVJCR-12.7-X-13
	16 x 16 x 130	SVJCL-1616X-13	SVJCR-1616X-13
	16 x 16 x 75	SVJCL-1616F-13	SVJCR-1616F-13
20 x 20 x 120	SVJCL-2020X-13	SVJCR-2020X-13	
VC..-1604..	12 x 12 x 130	SVJCL-1212X-16	SVJCR-1212X-16
	12 x 12 x 90	SVJCL-1212G-16	SVJCR-1212G-16
	12.7 x 12.7 x 130	SVJCL-12.7-X-16	SVJCR-12.7-X-16
	16 x 16 x 130	SVJCL-1616X-16	SVJCR-1616X-16
	16 x 16 x 75	SVJCL-1616F-16	SVJCR-1616F-16
20 x 20 x 120	SVJCL-2020X-16	SVJCR-2020X-16	

Porte-outils avec arrosage intégré
 Halter mit integrierter Kühlmittelzufuhr
 Holders with integrated coolant supply

35°

SVJ-JET

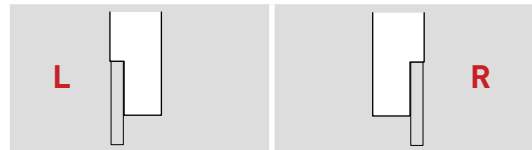
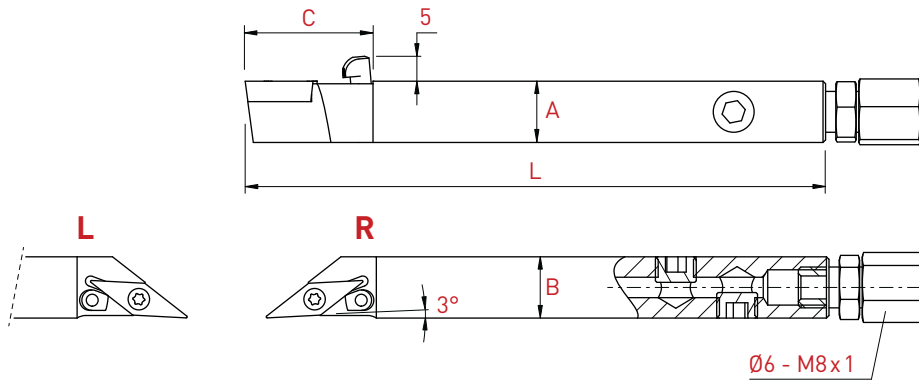

Plaquettes WSP Inserts	A x B x L	C	Art. N°	Art. N°
VC...-1103..	10 x 10 x 110	21	SVJCL-1010J-11-JET	SVJCR-1010J-11-JET
	12 x 12 x 110	21	SVJCL-1212J-11-JET	SVJCR-1212J-11-JET
	12.7 x 12.7 x 110	21	SVJCL-12.7-J-11-JET	SVJCR-12.7-J-11-JET
	16 x 16 x 110	21	SVJCL-1616J-11-JET	SVJCR-1616J-11-JET
	20 x 20 x 120	21	SVJCL-2020J-11-JET	SVJCR-2020J-11-JET
VC...-1303..	10 x 10 x 110	26	SVJCL-1010J-13-JET	SVJCR-1010J-13-JET
	12 x 12 x 110	26	SVJCL-1212J-13-JET	SVJCR-1212J-13-JET
	12.7 x 12.7 x 110	26	SVJCL-12.7-J-13-JET	SVJCR-12.7-J-13-JET
	16 x 16 x 110	26	SVJCL-1616J-13-JET	SVJCR-1616J-13-JET
	20 x 20 x 110	26	SVJCL-2020J-13-JET	SVJCR-2020J-13-JET
VC...-1604..	12 x 12 x 130	30	SVJCL-1212J-16-JET	SVJCR-1212J-16-JET
	12.7 x 12.7 x 130	30	SVJCL-12.7-J-16-JET	SVJCR-12.7-J-16-JET
	16 x 16 x 130	30	SVJCL-1616J-16-JET	SVJCR-1616J-16-JET
	20 x 20 x 120	30	SVJCL-2020J-16-JET	SVJCR-2020J-16-JET

ISO-LINE

Porte-outils

Halter

Holder

35°

SVX

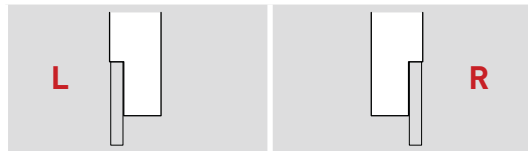
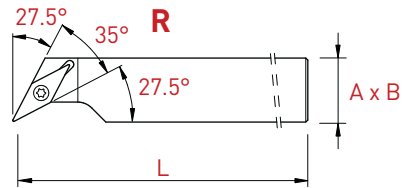
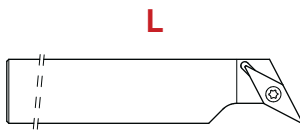

Plaquettes WSP Inserts	A x B x L	Art. N°	Art. N°
VC..-1103..	16 x 16 x 130	SVXCL-1616X-11	SVXCR-1616X-11
	16 x 16 x 75	SVXCL-1616F-11	SVXCR-1616F-11
	20 x 20 x 120	SVXCL-2020X-11	SVXCR-2020X-11

Porte-outils

Halter

Holder

35°

SV-CL/R

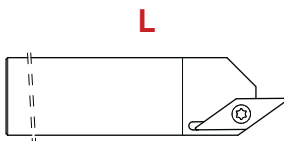

tournage arrière
rückwärts drehen
back turning

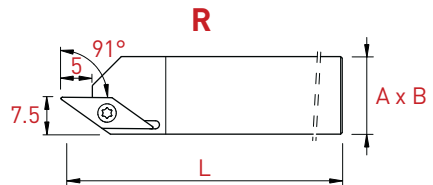

Plaquettes WSP Inserts	A x B x L	Art. N°	Art. N°
VCG..-1103..	12 x 12 x 130	SV-CL-1212X-11	SV-CR-1212X-11
	12 x 12 x 90	SV-CL-1212G-11	SV-CR-1212G-11
	12.7 x 12.7 x 130	SV-CL-12.7-X-11	SV-CR-12.7-X-11
	16 x 16 x 130	SV-CL-1616X-11	SV-CR-1616X-11
	16 x 16 x 75	SV-CL-1616F-11	SV-CR-1616F-11
	20 x 20 x 120	SV-CL-2020X-11	SV-CR-2020X-11

Porte-outils compatibles avec plaquettes VCGT FL/FR-X10°

Passende Halter zu den Wendepplatten VCGT FL/FR-X10°

Holder compatible with inserts VCGT FL/FR-X10°

35°

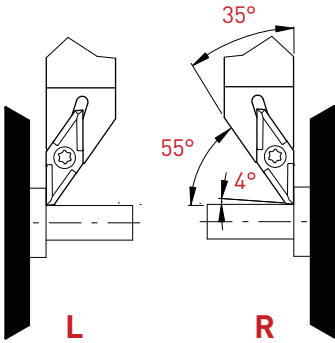

	Art. N°
R	SVACR-...-11
L	SVACL-...-11

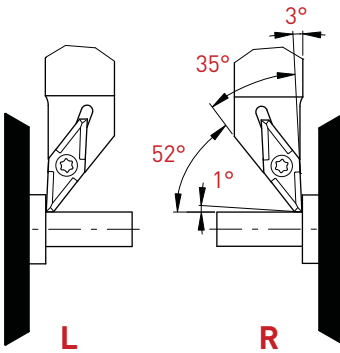

	Art. N°
R	SVJCR-...-11
L	SVJCL-...-11

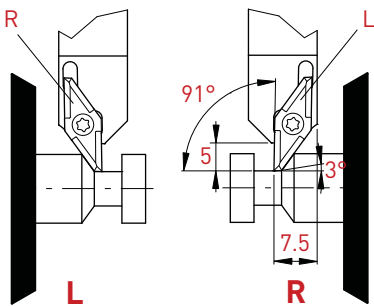

	Art. N°
R	SV-CR-...-11
L	SV-CL-...-11



**VCGT
FL / FR-X10**

R		Art. N°	PVD					non revêtu unbeschichtet uncoated	
			TiAlN	HTA	TiAlX	HTAX	TiN	K10	K20
0.03	VCGT-1103003-FL-X10	■	■				■	■	■
0.08	VCGT-1103008-FL-X10	■	■				■	■	■
0.1	VCGT-110301-FL-X10	■	■				■	■	■
0.2	VCGT-110302-FL-X10	■	■				■	■	■
0.03	VCGT-1103003-FR-X10	■	■	■	■	■	■	■	■
0.08	VCGT-1103008-FR-X10	■	■	■	■	■	■	■	■
0.1	VCGT-110301-FR-X10	■	■	■	■	■	■	■	■
0.2	VCGT-110302-FR-X10	■	■	■	■	■	■	■	■

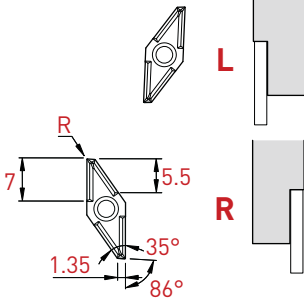

**VCGT
ELP/ERP-X10**

R		Art. N°	PVD					non revêtu unbeschichtet uncoated	
			TiAlN	HTA	TiAlX	HTAX	TiN	K10	K20
0.03	VCGT-1103003-ELP-X10	■	■				■	■	■
0.08	VCGT-1103008-ELP-X10	■	■				■	■	■
0.1	VCGT-110301-ELP-X10	■	■				■	■	■
0.2	VCGT-110302-ELP-X10	■	■				■	■	■
0.03	VCGT-1103003-ERP-X10	■	■	■	■	■	■	■	■
0.08	VCGT-1103008-ERP-X10	■	■	■	■	■	■	■	■
0.1	VCGT-110301-ERP-X10	■	■	■	■	■	■	■	■
0.2	VCGT-110302-ERP-X10	■	■	■	■	■	■	■	■

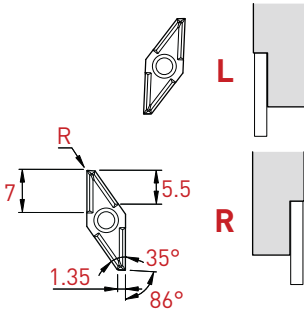

Plaquettes en métal dur

VHM-Wendeplatten

Solid carbide inserts

35°

VCGT-K18

VCGW-0



VCGT
FN-K18

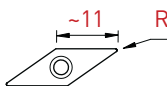

R	Art. N°	PVD		non revêtu unbeschichtet uncoated
		HTA	HTiN	K10
0.05	VCGT-1103005-FN-K18	■	■	■
0.1	VCGT-110301-FN-K18	■	■	■
0.2	VCGT-110302-FN-K18	■	■	■
0.4	VCGT-110304-FN-K18	■	■	■



VCGW
FN-0

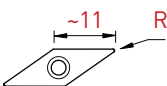

R	Art. N°	PVD		non revêtu unbeschichtet uncoated
		HTA	HTiN	K10
0.05	VCGW-1103005-FN-0	■	■	■
0.1	VCGW-110301-FN-0	■	■	■
0.2	VCGW-110302-FN-0	■	■	■
0.4	VCGW-110304-FN-0	■	■	■



VCGT
FN-X8

R	Art. N°	PVD			non revêtu unbeschichtet uncoated	
		TiAlN	HTA	TiN	K10	K20
0.05	VCGT-1103005-FN-X8	■	■	■	■	■
0.08	VCGT-1103008-FN-X8	■	■		■	■
0.1	VCGT-110301-FN-X8	■	■	■	■	■
0.15	VCGT-1103015-FN-X8	■	■		■	■
0.2	VCGT-110302-FN-X8	■	■	■	■	■
0.4	VCGT-110304-FN-X8	■	■	■	■	■
0.05	VCGT-1303005-FN-X8	■	■	■	■	■
0.1	VCGT-130301-FN-X8	■	■	■	■	■
0.2	VCGT-130302-FN-X8	■	■	■	■	■
0.4	VCGT-130304-FN-X8	■	■	■	■	■
0.05	VCGT-1604005-FN-X8	■	■	■	■	■
0.1	VCGT-160401-FN-X8	■	■	■	■	■
0.2	VCGT-160402-FN-X8	■	■	■	■	■
0.4	VCGT-160404-FN-X8	■	■	■	■	■

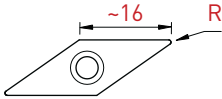
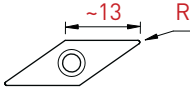
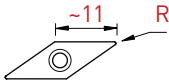

VCGT
ENP-X8

R	Art. N°	PVD		non revêtu unbeschichtet uncoated
		TiAlN	TiN	K20
0.05	VCGT-1103005-ENP-X8	■	■	■
0.08	VCGT-1103008-ENP-X8	■		■
0.1	VCGT-110301-ENP-X8	■	■	■
0.15	VCGT-1103015-ENP-X8	■		■
0.2	VCGT-110302-ENP-X8	■	■	■
0.4	VCGT-110304-ENP-X8	■	■	■
0.05	VCGT-1303005-ENP-X8	■		■
0.1	VCGT-130301-ENP-X8	■		■
0.2	VCGT-130302-ENP-X8	■		■
0.4	VCGT-130304-ENP-X8	■		■
0.05	VCGT-1604005-ENP-X8	■	■	■
0.1	VCGT-160401-ENP-X8	■	■	■
0.2	VCGT-160402-ENP-X8	■	■	■
0.4	VCGT-160404-ENP-X8	■	■	■

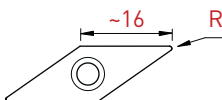
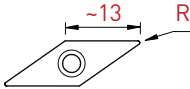
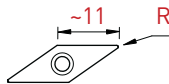

Plaquettes en métal dur

VHM-Wendeplatten

Solid carbide inserts

35°

VCGT-X17



VCGT
FN-X17

R	Art. N°	PVD			non revêtu unbeschichtet uncoated	
		TiAIN	HTA	TiN	K10	K20
0.05	VCGT-1103005-FN-X17	■	■	■	■	■
0.08	VCGT-1103008-FN-X17	■	■	■	■	■
0.1	VCGT-110301-FN-X17	■	■	■	■	■
0.15	VCGT-1103015-FN-X17	■	■	■	■	■
0.2	VCGT-110302-FN-X17	■	■	■	■	■
0.4	VCGT-110304-FN-X17	■	■	■	■	■
0.05	VCGT-1303005-FN-X17	■	■	■	■	■
0.1	VCGT-130301-FN-X17	■	■	■	■	■
0.2	VCGT-130302-FN-X17	■	■	■	■	■
0.4	VCGT-130304-FN-X17	■	■	■	■	■
0.05	VCGT-1604005-FN-X17	■	■	■	■	■
0.1	VCGT-160401-FN-X17	■	■	■	■	■
0.2	VCGT-160402-FN-X17	■	■	■	■	■
0.4	VCGT-160404-FN-X17	■	■	■	■	■
0.8	VCGT-160408-FN-X17	■	■	■	■	■

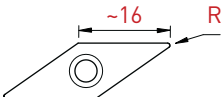
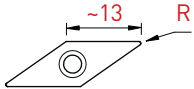
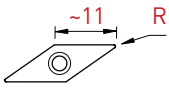

VCGT
ENP-X17

R	Art. N°	PVD		non revêtu unbeschichtet uncoated
		TiAIN	TiN	K20
0.05	VCGT-1103005-ENP-X17	■	■	■
0.08	VCGT-1103008-ENP-X17	■	■	■
0.1	VCGT-110301-ENP-X17	■	■	■
0.15	VCGT-1103015-ENP-X17	■	■	■
0.2	VCGT-110302-ENP-X17	■	■	■
0.4	VCGT-110304-ENP-X17	■	■	■
0.05	VCGT-1303005-ENP-X17	■	■	■
0.1	VCGT-130301-ENP-X17	■	■	■
0.2	VCGT-130302-ENP-X17	■	■	■
0.4	VCGT-130304-ENP-X17	■	■	■
0.05	VCGT-1604005-ENP-X17	■	■	■
0.1	VCGT-160401-ENP-X17	■	■	■
0.2	VCGT-160402-ENP-X17	■	■	■
0.4	VCGT-160404-ENP-X17	■	■	■
0.8	VCGT-160408-ENP-X17	■	■	■

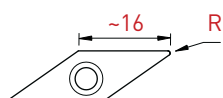
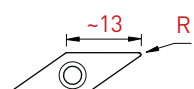
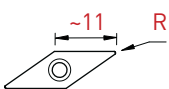



VCGT
FN-X25

R	Art. N°	PVD			non revêtu unbeschichtet uncoated	
		TiAIN	HTA	TiN	K10	K20
		P M N S	P M N S	P M N	<input type="checkbox"/>	<input type="checkbox"/>
0.05	VCGT-1103005-FN-X25	■	■	■	■	■
0.1	VCGT-110301-FN-X25	■	■	■	■	■
0.2	VCGT-110302-FN-X25	■	■	■	■	■
0.4	VCGT-110304-FN-X25	■	■	■	■	■
0.05	VCGT-1303005-FN-X25	■	■	■	■	■
0.1	VCGT-130301-FN-X25	■	■	■	■	■
0.2	VCGT-130302-FN-X25	■	■	■	■	■
0.4	VCGT-130304-FN-X25	■	■	■	■	■
0.8	VCGT-130308-FN-X25	■	■	■	■	■
0.05	VCGT-1604005-FN-X25	■	■	■	■	■
0.1	VCGT-160401-FN-X25	■	■	■	■	■
0.2	VCGT-160402-FN-X25	■	■	■	■	■
0.4	VCGT-160404-FN-X25	■	■	■	■	■
0.8	VCGT-160408-FN-X25	■	■	■	■	■

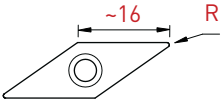
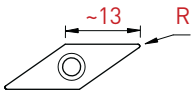
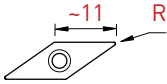

VCGT
ENP-X25

R	Art. N°	PVD		non revêtu unbeschichtet uncoated
		TiAIN	TiN	K20
		P M N S	P M N	<input type="checkbox"/>
0.05	VCGT-1103005-ENP-X25	■	■	■
0.1	VCGT-110301-ENP-X25	■	■	■
0.2	VCGT-110302-ENP-X25	■	■	■
0.4	VCGT-110304-ENP-X25	■	■	■
0.05	VCGT-1303005-ENP-X25	■	■	■
0.1	VCGT-130301-ENP-X25	■	■	■
0.2	VCGT-130302-ENP-X25	■	■	■
0.4	VCGT-130304-ENP-X25	■	■	■
0.8	VCGT-130308-ENP-X25	■	■	■
0.05	VCGT-1604005-ENP-X25	■	■	■
0.1	VCGT-160401-ENP-X25	■	■	■
0.2	VCGT-160402-ENP-X25	■	■	■
0.4	VCGT-160404-ENP-X25	■	■	■
0.8	VCGT-160408-ENP-X25	■	■	■

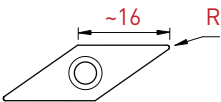
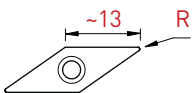
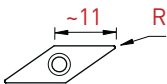

Plaquettes en métal dur

VHM-Wendeplatten

Solid carbide inserts

35°

VCGT-X20

VCGT
ENP-X20

PVD

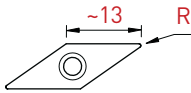

R	Art. N°	ZTA	HTX
0.2	VCGT-130302-ENP-X20	■	■
0.4	VCGT-130304-ENP-X20	■	■
0.8	VCGT-130308-ENP-X20	■	■

ISO-LINE

Plaquettes en métal dur
VHM-Wendeplatten
Solid carbide inserts

35°

VCMT-XF3
VCMT-XF2



VCMT
EN-XF3

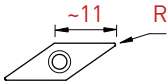

R	Art. N°	PVD	
		TAC	HTAC
0.2	VCMT-110302-EN-XF3	■	■
0.4	VCMT-110304-EN-XF3	■	■

PVD	
P	P
M	M
N	N
S	S
TAC	HTAC



VCMT
EN-XF2

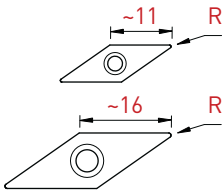

R	Art. N°	PVD		CVD
		TAC	HTAC	HTi5
0.2	VCMT-110302-EN-XF2	■	■	■
0.4	VCMT-110304-EN-XF2	■	■	■
0.4	VCMT-160404-EN-XF2	■	■	■

PVD		CVD
P	P	P
M	M	M
N	N	
S	S	
TAC	HTAC	HTi5

Plaquettes en métal dur

VHM-Wendeplatten

Solid carbide inserts

35°

VCMT-MF

VCMT-HF



VCMT
EN-MF

R	Art. N°	PVD		CVD	
		P	M	P	M
		Tmax		Ti4	
0.2	VCMT-110302-EN-MF	■	■	■	■
0.4	VCMT-110304-EN-MF	■	■	■	■
0.4	VCMT-160404-EN-MF	■	■	■	■

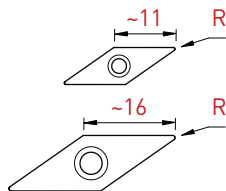

VCMT
EN-HF

R	Art. N°	PVD		CVD	
		P	M	P	M
		Tmax		Ti4	
0.4	VCMT-110304-EN-HF	■	■	■	■
0.8	VCMT-110308-EN-HF	■	■	■	■
0.4	VCMT-160404-EN-HF	■	■	■	■
0.8	VCMT-160408-EN-HF	■	■	■	■

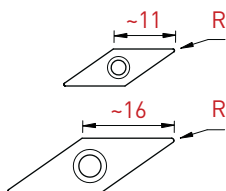



**VCGT
FN-X8**

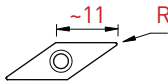











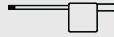

		CERMET	
		PVD	non revêtu unbeschichtet uncoated
		<input checked="" type="checkbox"/> P <input checked="" type="checkbox"/> M <input type="checkbox"/> <input type="checkbox"/>	<input checked="" type="checkbox"/> P <input type="checkbox"/> <input type="checkbox"/> <input type="checkbox"/>
R	Art. N°	CTA	CN6
0.05	VCGT-1103005-FN-X8	<input checked="" type="checkbox"/>	<input checked="" type="checkbox"/>
0.1	VCGT-110301-FN-X8	<input checked="" type="checkbox"/>	<input checked="" type="checkbox"/>
0.2	VCGT-110302-FN-X8	<input checked="" type="checkbox"/>	<input checked="" type="checkbox"/>
0.4	VCGT-110304-FN-X8	<input checked="" type="checkbox"/>	<input checked="" type="checkbox"/>

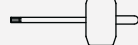
Pièces de rechange et accessoires

Ersatzteile und Zubehör

Spare parts and accessories

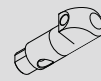
Vis et clés de rechange Ersatzschrauben und Schlüssel Spare screws and keys	Porte-outils Halter Holders	Vis Schrauben Screw	Clé Schlüssel Key		
				Option	Serrage Drehmoment Torque
	Series SC...-06 Series SD...-07 Series SV...-11	V-M2.5X7.8-T8 	C-T8 	SET-NM-TX8	1.3 Nm
	Series SV...-13	V-M3X7.3-T8-ISO 	C-T8 	SET-NM-TX8	2.0 Nm
	Series SC...-09 Series SD...-11 Series SV...-16	V-M4X9-T15-ISO 	C-T15 	SET-NM-TX15	3.0 Nm

Pièces de rechange JET Ersatzteile JET Spare parts JET	L Pour réf. For ref. Für Ref	 *	 *	 *
		Art. N°	Art. N°	Art. N°
	S...L-10...-JET	JJL-4X12-D1.5	J-M8X1-D6	JB-M8X1
	S...L-12...-JET S...L-12.7...-JET	JJL-4X14-D1.5	J-M8X1-D6	JB-M8X1
	S...L-16...-JET S...L-20...-JET	JJL-4X17-D1.5	J-M8X1-D6	JB-M8X1
R Pour réf. For ref. Für Ref	 *	 *	 *	
	Art. N°	Art. N°	Art. N°	
	S...R-10...-JET	JJR-4X12-D1.5	J-M8X1-D6	JB-M8X1
	S...R-12...-JET S...R-12.7...-JET	JJR-4X14-D1.5	J-M8X1-D6	JB-M8X1
	S...R-16...-JET S...R-20...-JET	JJR-4X17-D1.5	J-M8X1-D6	JB-M8X1

* livré avec chaque porte-outil
mit jedem Halter geliefert
delivered with each holder

Paramètres de coupe indicatifs

Empfohlene Schnittwerte

Standard machining data

ISO-Line	Tough grade, for normal to difficult machining conditions	Wear resistant grade, for finishing and light machining	Acier Stahl Steel						Inox Rostfreistahl Stainless steel			
			Acier de décolletage Automatenstahl Free-cutting steel		Acier faiblement allié Leicht legierter Stahl Low alloyed steel		Acier fortement allié Hochlegierter Stahl High alloyed steel		Austénitique Austenitisch Austenitic		Martensitique Martensitisch Martensitic	
			VC (m/min)	F (mm/U)	VC (m/min)	F (mm/U)	VC (m/min)	F (mm/U)	VC (m/min)	F (mm/U)	VC (m/min)	F (mm/U)
FN-X8	TiAlN	HTA	80-180	0.01-0.12	60-150	0.01-0.10	50-120	0.01-0.08	60-140	0.01-0.12	60-140	0.01-0.12
	TiN		80-170	0.01-0.12	60-140	0.01-0.10			60-120	0.01-0.12	60-120	0.01-0.12
	N	HN										
ENP-X8	TiAlN	HTA	80-180	0.03-0.15	60-160	0.03-0.12	50-120	0.03-0.10	60-140	0.03-0.12	60-140	0.03-0.15
	TiN		80-170	0.03-0.15	60-150	0.03-0.12			60-120	0.03-0.12	60-120	0.03-0.15
	N	HN										
FN-X17	TiAlN	HTA	80-180	0.01-0.12	60-150	0.01-0.10			60-140	0.01-0.15	60-140	0.01-0.15
	TiN		80-170	0.01-0.12					60-120	0.01-0.15	60-120	0.01-0.15
	N	HN										
ENP-X17	TiAlN	HTA	80-180	0.03-0.15	60-160	0.03-0.12	50-120	0.03-0.10	60-140	0.03-0.15	60-140	0.03-0.18
	TiN		80-170	0.03-0.15	60-150	0.03-0.12			60-120	0.01-0.15	60-120	0.03-0.18
	N	HN										
FN-X25	TiAlN	HTA							60-140	0.01-0.12		
	TiN								60-120	0.01-0.12		
	N	HN										
ENP-X25	TiAlN	HTA							60-140	0.03-0.12	60-140	0.03-0.15
	TiN								60-120	0.03-0.12	60-120	0.03-0.15
	N	HN										
ENP-X20	ZTA								60-140	0.03-0.18	60-140	0.03-0.18
	HTiX								60-140	0.03-0.18	60-140	0.03-0.18

G tolerance class			Special 35° VC...-11									
FL / FR-X10	TiAlN	HTA	80-180	0.01-0.12	60-150	0.01-0.10	50-120	0.01-0.08	60-140	0.01-0.12	60-140	0.01-0.12
	TiAlX	HTAX	80-180	0.01-0.12	60-150	0.01-0.10	50-120	0.01-0.08	60-140	0.01-0.12	60-140	0.01-0.12
	TiN		80-170	0.01-0.12	60-140	0.01-0.10			60-120	0.01-0.12	60-120	0.01-0.12
	N	HN										
ELP/ERP-X10	TiAlN	HTA	80-180	0.03-0.15	60-160	0.03-0.12	50-120	0.03-0.10	60-140	0.03-0.12	60-140	0.03-0.15
	TiAlX	HTAX	80-180	0.03-0.15	60-160	0.03-0.12	50-120	0.03-0.10	60-140	0.03-0.12	60-140	0.03-0.15
	TiN		80-170	0.03-0.15	60-150	0.03-0.12			60-120	0.03-0.12	60-120	0.03-0.15
	N	HN										
FN-K18		HTA	80-180	0.01-0.10	60-150	0.01-0.10			60-140	0.01-0.10	60-140	0.01-0.10
		HTiN	80-170	0.01-0.10	60-140	0.01-0.10			60-120	0.01-0.10	60-120	0.01-0.10
		HN										
FN-0		HTA	80-150	0.01-0.10								
		HTiN	80-140	0.01-0.10								
		HN										



N Alliage d'aluminium et non ferreux Aluminium- und Nichteisenlegierungen Aluminium and non-ferrous alloys								S Titane et superalliages Titan and Superlegierungen Titanium and superalloys					
Aluminium		Al-Si		Cuivre Kupfer Copper		Laiton & bronze Messing & Bronze Brass & bronze		Ti grade 1 - 3		Ti grade 4 - 6		Superalliages Superlegierungen Superalloys	
VC (m/min)	F (mm/U)	VC (m/min)	F (mm/U)	VC (m/min)	F (mm/U)	VC (m/min)	F (mm/U)	VC (m/min)	F (mm/U)	VC (m/min)	F (mm/U)	VC (m/min)	F (mm/U)
		150-1600	0.01-0.15	80-300	0.01-0.12	100-400	0.01-0.15			30-60	0.01-0.12	40-70	0.01-0.10
120-2200	0.01-0.18	150-1600	0.01-0.15	80-300	0.01-0.12	100-400	0.01-0.15						
120-2000	0.01-0.18	150-1500	0.01-0.15	80-250	0.01-0.12	100-300	0.01-0.15	30-70	0.01-0.12				
		150-800	0.03-0.18	80-300	0.03-0.15					30-60	0.03-0.12	40-70	0.03-0.10
		150-800	0.03-0.18	80-300	0.03-0.15								
		150-800	0.03-0.18	80-250	0.03-0.15								
		150-1600	0.01-0.18	80-300	0.01-0.15	100-400	0.01-0.18			30-70	0.01-0.15	40-80	0.01-0.12
120-2200	0.01-0.25	150-1600	0.01-0.18	80-300	0.01-0.15	100-400	0.01-0.18						
120-2000	0.01-0.25	150-1500	0.01-0.18	80-250	0.01-0.15	100-300	0.01-0.18	40-80	0.01-0.15				
		150-800	0.03-0.20	80-300	0.03-0.18					30-70	0.03-0.15	40-80	0.03-0.12
		150-800	0.03-0.20	80-300	0.03-0.18								
		150-800	0.03-0.20	80-250	0.03-0.18								
		150-1600	0.01-0.22	80-300	0.01-0.18					30-60	0.01-0.12	40-70	0.01-0.10
120-2200	0.01-0.30	150-1600	0.01-0.22	80-300	0.01-0.18								
120-2000	0.01-0.30	150-1500	0.01-0.22	80-250	0.01-0.18			30-70	0.01-0.12				
		150-800	0.03-0.25	80-300	0.03-0.20					30-60	0.03-0.12	40-70	0.03-0.10
		150-800	0.03-0.25	80-300	0.03-0.20								
		150-800	0.03-0.25	80-250	0.03-0.20								
		150-800	0.03-0.25	80-300	0.03-0.20					40-90	0.03-0.15	40-100	0.03-0.15
		150-800	0.03-0.25	80-300	0.03-0.20					40-80	0.03-0.15	40-90	0.03-0.15
		150-1600	0.01-0.18	80-300	0.01-0.15	100-400	0.01-0.18			30-60	0.01-0.12	40-70	0.01-0.10
								30-70	0.01-0.12	30-60	0.01-0.12	40-70	0.01-0.10
120-2200	0.01-0.20	150-1600	0.01-0.18	80-300	0.01-0.15	100-400	0.01-0.18						
120-2000	0.01-0.20	150-1500	0.01-0.18	80-250	0.01-0.15	100-300	0.01-0.18	30-70	0.01-0.12				
		150-1600	0.03-0.20	80-300	0.03-0.18					30-60	0.03-0.12	40-70	0.03-0.10
										30-60	0.03-0.12	40-70	0.03-0.10
		150-1600	0.03-0.20	80-300	0.01-0.18								
		150-1500	0.03-0.20	80-250	0.01-0.18								
		150-1600	0.01-0.12	80-300	0.01-0.10					30-70	0.01-0.10	40-80	0.01-0.10
120-2200	0.01-0.15	150-1600	0.01-0.12	80-300	0.01-0.10								
120-2000	0.01-0.15	150-1500	0.01-0.12	80-250	0.01-0.10			40-80	0.01-0.10				
						100-400	0.01-0.18						
						100-400	0.01-0.18						
						100-300	0.01-0.18						

Paramètres de coupe indicatifs

Empfohlene Schnittwerte

Standard machining data

ISO-Line	M tolerance class	Tough grade, for normal to difficult machining conditions	Wear resistant grade, for finishing and tight machining	Acier Stahl Steel						Inox Rostfreistahl Stainless steel			
				Acier de décolletage Automatenstahl Free-cutting steel		Acier faiblement allié Leicht legierter Stahl Low alloyed steel		Acier fortement allié Hochlegierter Stahl High alloyed steel		Austénitique Austenitisch Austenitic		Martensitique Martensitisch Martensitic	
				VC (m/min)	F (mm/U)	VC (m/min)	F (mm/U)	VC (m/min)	F (mm/U)	VC (m/min)	F (mm/U)	VC (m/min)	F (mm/U)
EN-XF3	TAC	HTAC		100-200	0.03-0.15	80-160	0.03-0.12	50-120	0.03-0.10	60-140	0.03-0.12	60-140	0.03-0.15
EN-XF2	TAC	HTAC		100-200	0.03-0.15	80-160	0.03-0.12	50-120	0.03-0.10	60-140	0.03-0.12	60-140	0.03-0.15
		HTI5		100-250	0.03-0.15	80-220	0.03-0.12	50-180	0.03-0.10	80-200	0.03-0.12	80-200	0.03-0.15
EN-MF2	TAC	HTAC		100-200	0.04-0.15	80-160	0.04-0.12	50-120	0.04-0.10	60-140	0.04-0.12	60-140	0.04-0.15
		HTI5		100-250	0.04-0.15	80-220	0.04-0.12	50-180	0.04-0.10	80-200	0.04-0.12	80-200	0.04-0.15
EN-MF	Tmax			100-220	0.04-0.30	80-180	0.04-0.25	50-150	0.04-0.20	60-150	0.04-0.25	60-150	0.04-0.25
		Ti4		100-250	0.05-0.30	80-220	0.05-0.25	50-180	0.05-0.20	80-200	0.05-0.25	80-200	0.05-0.25
EN-HF3	TiX	HTiX		100-220	0.06-0.35	80-180	0.06-0.30	50-150	0.06-0.25	60-150	0.06-0.25	60-150	0.06-0.25
		Ti6		100-250	0.06-0.35	80-220	0.06-0.30	50-180	0.06-0.25	80-200	0.06-0.25	80-200	0.06-0.25
EN-HF	Tmax			100-220	0.08-0.40	80-180	0.08-0.35	50-150	0.08-0.30	60-150	0.08-0.30	60-150	0.08-0.30
		TAC		100-200	0.08-0.40	80-160	0.08-0.35	50-140	0.08-0.30	60-140	0.08-0.30	60-140	0.08-0.30
		Ti4		100-250	0.08-0.40	80-220	0.08-0.35	50-180	0.08-0.30	80-200	0.08-0.30	80-200	0.08-0.30
		Ti5	HTi5		100-280	0.08-0.40	80-250	0.08-0.35	50-200	0.08-0.30	80-220	0.08-0.30	80-220

ISO-Line CERMET												
FN-X8 CERMET	CTA		100-350	0.01-0.12	80-300	0.01-0.10	70-250	0.01-0.08	80-250	0.01-0.12	80-250	0.01-0.12
		CN6	100-300	0.01-0.12	80-250	0.01-0.10	70-200	0.01-0.08				
ENP-KX CERMET	CT7	HCT7	100-350	0.03-0.20	80-300	0.03-0.18	70-250	0.03-0.15	80-250	0.03-0.18	80-250	0.03-0.18
		CN6	100-300	0.03-0.20	80-250	0.03-0.18	70-200	0.03-0.15				
EN-KM CERMET	CT7	HCT7	100-350	0.03-0.25	80-300	0.03-0.20	70-250	0.03-0.18	80-250	0.03-0.20	80-250	0.03-0.20
		CN6	100-300	0.03-0.25	80-250	0.03-0.20	70-200	0.03-0.18				



N Allages d'aluminium et non ferreux Aluminium- und Nichteisenlegierungen Aluminium and non-ferrous alloys								S Titane et superalliages Titan und Superlegierungen Titanium and superalloys					
Aluminium		Al-Si		Cuivre Kupfer Copper		Laiton & bronze Messing & Bronze Brass & bronze		Ti grade 1 - 3		Ti grade 4 - 6		Superalliages Superlegierungen Superalloys	
VC (m/min)	F (mm/U)	VC (m/min)	F (mm/U)	VC (m/min)	F (mm/U)	VC (m/min)	F (mm/U)	VC (m/min)	F (mm/U)	VC (m/min)	F (mm/U)	VC (m/min)	F (mm/U)
		120-1500	0.03-0.20	80-300	0.03-0.15	100-400	0.03-0.18			30-70	0.03-0.15	40-80	0.03-0.12
						100-400	0.03-0.18			30-70	0.03-0.15	40-80	0.03-0.12
		120-1500	0.04-0.20	80-300	0.04-0.15	100-400	0.04-0.18			30-70	0.04-0.15	40-80	0.04-0.12
										30-70	0.06-0.20	40-80	0.06-0.20

Conseils d'utilisation

Anwendungsempfehlungen

Application recommendations

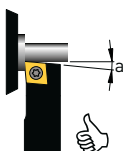

• pour un meilleur état de surface et une meilleure stabilité d'usinage, choisir une géométrie d'outil permettant un angle "a" le plus petit possible

• für bessere Oberflächegüte und Bearbeitungsstabilität, muss die Werkzeuggeometrie mit kleinstmöglichem Winkel "a" ausgewählt werden

• for a better surface finish and better machining stability, choose a tool geometry with angle "a" as small as possible

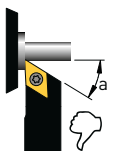

rapport hauteur de passe / rayon d'outil
Verhältnis zwischen Spantiefe und Werkzeugradius
machining depth / tool radius ratio

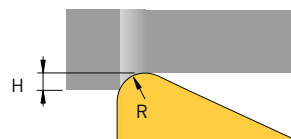

$H_{min} = 0.7 \times R$
 $R_{max} = 1.4 \times H$

Porte-outils / Halter / Holders

H

Système de serrage monobloc
Einteiliges Klemmsystem
Monobloc top clamp system

H JET

Porte-outils avec arrosage intégré
Halter mit integrierter Kühlmittelzufuhr
Holders with integrated coolant supply

**HK
HUK
HM**

Lames
Stecklinge
Parting-off blades

Very rigid clamping system!

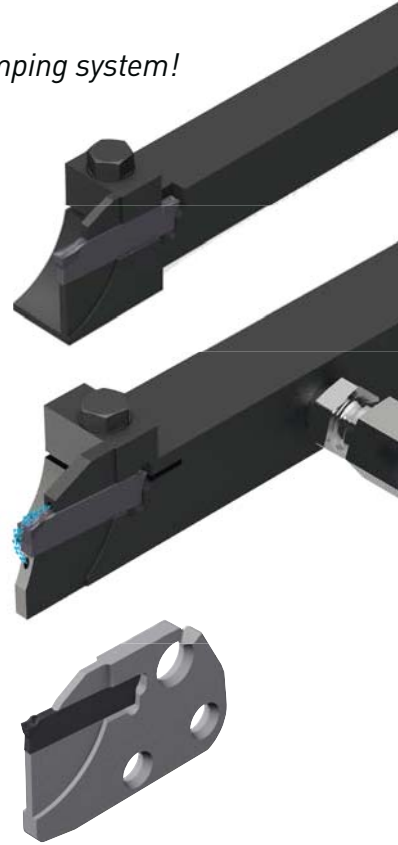

Plaquettes / WSP / Inserts

ET 15

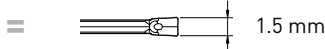

Ø max 32 mm

ET 20

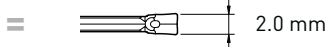

ET 25

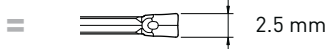

ET 30

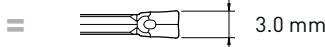

Ø max 44 mm



U



J



T



A

Index

Informations techniques
Technisches Informationen
Technical information > **8.02**

Géométries de coupe
Spanformgeometrie
Cutting geometries > **8.04**

Nuances
Sorten
Grades > **8.05**

H Series sans arrosage
ohne Kühlung
without coolant > **8.06**

Porte-outils
Halter
Holders **H JET Series** avec arrosage
mit Kühlung
with coolant > **8.07**

HK-HUK-HM Series > **8.08**

UN Series > **8.12**

UL-UR Series > **8.13**

JN Series > **8.14**

Plaquettes de tronçonnage
Abstechwendeplatten
Cut off inserts **JR Series** > **8.15**

TN Series > **8.16**

TR Series > **8.17**

AN Series > **8.18**

AR Series > **8.19**

Paramètres de coupe indicatifs
Empfohlene Schnittwerte
Standard machining data > **8.20**

Compact: seulement 20 mm pour les machines courantes

Kompakt: nur 20 mm für übliche Maschinen

Compact: only 20 mm for current machines

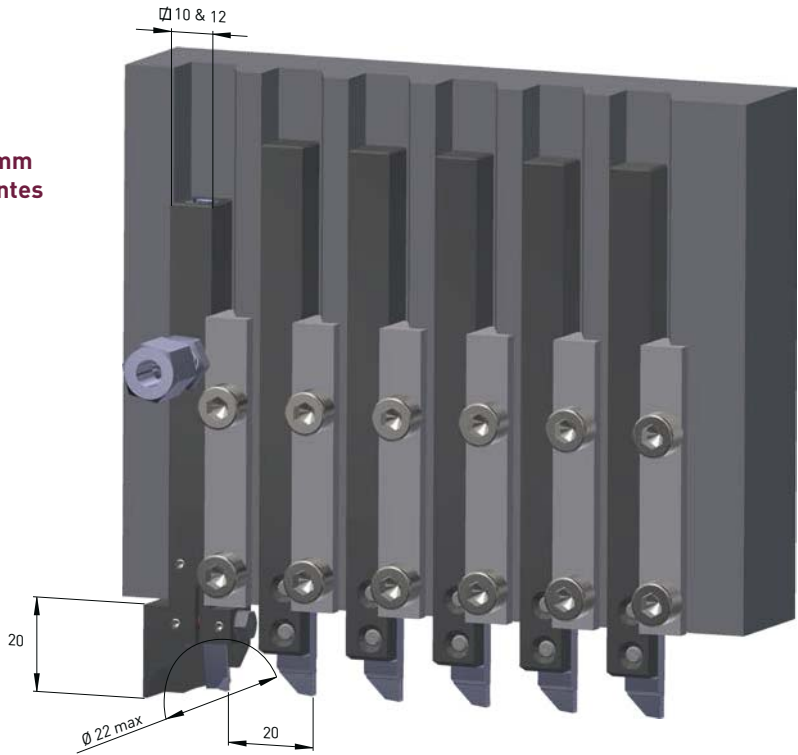

Facilité d'accès

Zugangseichtigkeit

Excellent accessibility

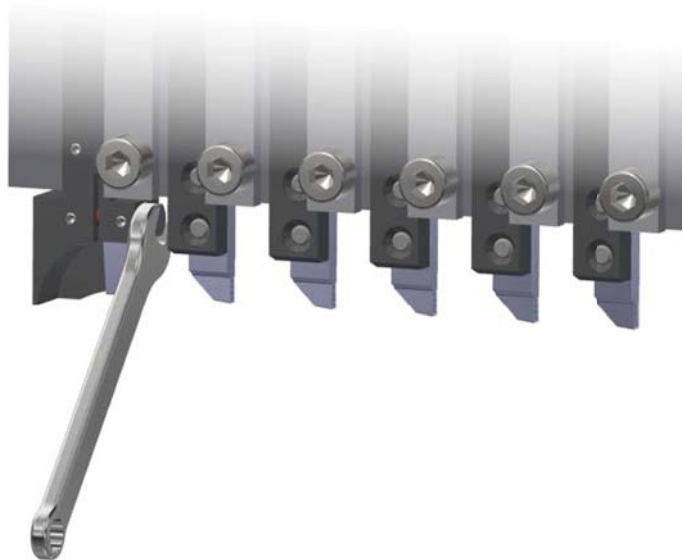

Changement de la plaque sans démontage

Veränderung der Platte ohne Zerlegung

Change of insert without disassembly

Butée de serrage
Spannungs-Anschlag
Clamping stop

Distance de serrage
 Anschlagabstand
 Distance clamping

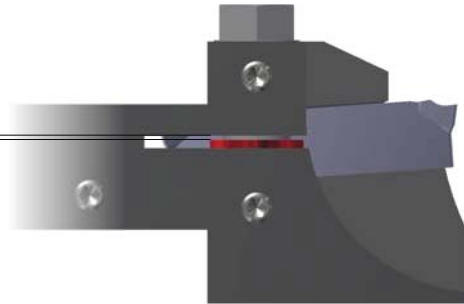

Recommendations de serrage:
 n'utiliser que la clé fournie
Spannungsempfehlungen:
 nur den gelieferten Schlüssel benutzen
Tightening recommendation:
 only use the delivered key

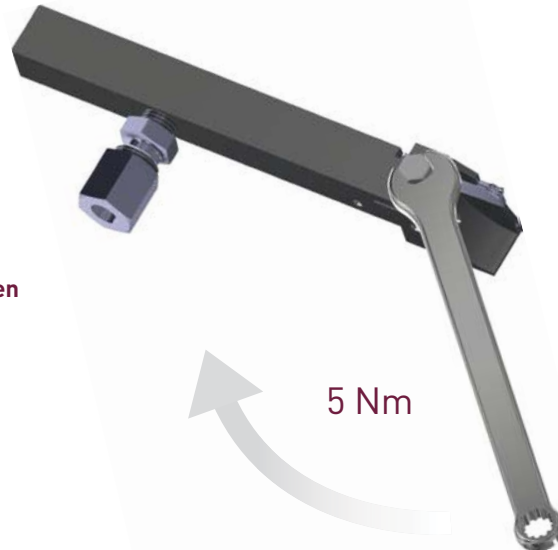

Support JET à double lubrification
JET Halter mit doppeltem Schmierung
Jet holder with double lubrication

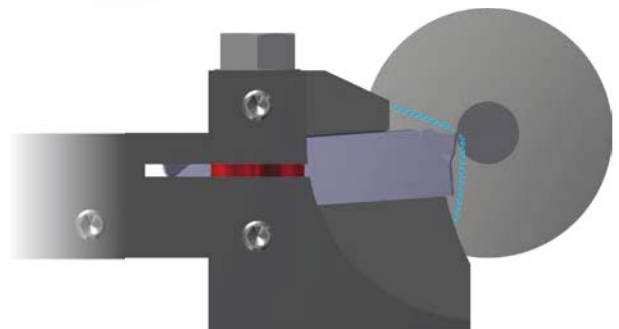

Géométries de coupe

Spanformgeometrie

Cutting geometries

UN

UL
UR

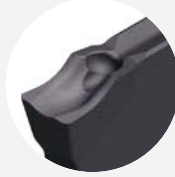

- géométrie positive universelle, faibles efforts de coupe
- bonne maîtrise du copeau
- 1^{er} choix pour l'inox

- allgemeine Geometrie, geringe Schnittkräfte
- gute Spankontrolle
- 1. Wahl für rostfreiem Stahl

- all-round geometry, low cutting forces
- efficient chip control
- 1st choice for stainless steel

JN

JR

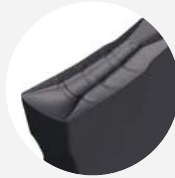

- géométrie universelle
- excellent rétrécissement du copeau pour un meilleur contrôle
- conseillé pour le tronçonnage de pièces à parois minces
- pour acier et inox

- allgemeine Geometrie
- ausgezeichnete Spanversmälnerung für eine bessere Spankontrolle
- für abstechen von dünnwandigen Teilen empfohlen
- für Stahl und rostfreiem Stahl

- all-round geometry
- very efficient arrow for a better chip control
- recommended for parting off of thin-walled parts
- for steel and stainless steel

TN

TR

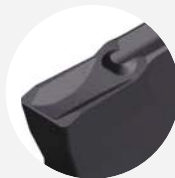

- géométrie négative
- utilisation dans des conditions de rigidité optimale
- pour les matières à haute ténacité
- universel pour les aciers et inox

- negative Geometrie
- bei stabilen Verhältnissen einsetzbar
- für hohe widerstandsfähige Rohstoffe
- allgemein für Stahl und rostfreiem Stahl

- negative geometry
- use in solid cutting conditions
- for high toughness material
- universal for steel and stainless steel

AN

AR

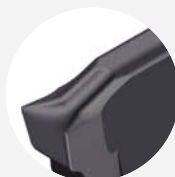

- géométrie fortement positive
- roule-copeau poli avec arêtes de coupe vives
- 1^{er} choix pour aluminium et matériaux non ferreux

- stark positive Geometrie
- geschliffene Spanrolle mit scharfe Schneidkanten
- 1. Wahl für Aluminium und Nichteisenmetalle

- very positive geometry
- polished chip roller with sharp cutting edge
- 1st choice for aluminium and non-ferrous materials

Nuances

Sorten

Grades

<p>P M N S</p> <p>TiAlN revêtement PVD PVD Beschichtung PVD coating</p>	<p>P M <input type="checkbox"/> <input type="checkbox"/></p> <p>Tmax revêtement PVD PVD Beschichtung PVD coating</p>	<p>P M <input type="checkbox"/> <input type="checkbox"/></p> <p>Zmax revêtement PVD PVD Beschichtung PVD coating</p>
<ul style="list-style-type: none"> pour l'usinage des aciers, aciers inoxydables et alliages de titane 1^{er} choix pour les avances faibles à modérées 	<ul style="list-style-type: none"> nuance pour usinage moyen à lourd des aciers, aciers alliés et inoxydables bonne résistance aux températures d'usinage élevées 1^{er} choix pour le tronçonnage des aciers au carbone et des aciers fortement alliés 	<ul style="list-style-type: none"> pour l'usinage des aciers, aciers inoxydables et alliages de titane en conditions défavorables bonne résistance aux chocs à des vitesses de coupe moyenne à faible 1^{er} choix pour le tronçonnage en coupe interrompue
<ul style="list-style-type: none"> für die Bearbeitung von Stahl, rostfreiem Stahl und Titanlegierungen beste Wahl für niedrige bis mittlere Vorschübe 	<ul style="list-style-type: none"> Sorte für mittlere bis hohe Belastung in Stahl und legierter Stahlbearbeitung gute Bearbeitungswarmfestigkeit für die Bearbeitung von legiertem Kohlenstahl und hoch legiertem Stahl bestens geeignet 	<ul style="list-style-type: none"> für die Bearbeitung von Stahl, rostfreiem Stahl und Titanlegierungen in schwierige Bearbeitungsfälle gute Bruchfestigkeit mit durchschnittliche bis niedrige Schnittgeschwindigkeit für die Bearbeitung in unterbrochenen Schnitte bestens geeignet
<ul style="list-style-type: none"> for machining of steel, stainless steel and titanium alloys first choice for low to average cutting speed 	<ul style="list-style-type: none"> grade for medium to heavy machining of steel, stainless steel and alloyed steel high machining heat resistance first choice for the machining of carbon steel and high alloyed steel 	<ul style="list-style-type: none"> for machining of steel, stainless steel and titanium alloys in unfavourable machining conditions good impact resistance with average to low cutting speed first choice for machining in interrupted cut
<p>P M <input type="checkbox"/> <input type="checkbox"/></p> <p>ZTi6 revêtement CVD CVD Beschichtung CVD coating</p>	<p><input type="checkbox"/> <input type="checkbox"/> N S</p> <p>AS revêtement PVD PVD Beschichtung PVD coating</p>	<p><input type="checkbox"/> <input type="checkbox"/> N S</p> <p>N non-revêtu unbeschichtet uncoated</p>
<ul style="list-style-type: none"> nuance très tenace grande résistance à la température 1^{er} choix pour les aciers «haute température» secondairement pour les aciers inox 	<ul style="list-style-type: none"> nuance pour métaux non ferreux très faible coefficient de frottement 1^{er} choix pour l'usinage des aluminiums jusqu'à 5% Si, des cuivres et titanes faiblement alliés 	<ul style="list-style-type: none"> nuance non revêtu recommandé pour l'usinage des matières non-ferreuses titane, laiton, cuivre, aluminium sans silicium, plastique
<ul style="list-style-type: none"> sehr zähe Sorte hohe Bearbeitungswarmfestigkeit 1. Wahl für „hohe Temperatur“ Stähle sekundär für rostfreie Stähle 	<ul style="list-style-type: none"> Sorte für Nichteisenmetalle sehr geringer Reibwert für die Bearbeitung von Aluminium bis 5% Si, Kupfer und niedriglegiertem Titan bestens geeignet 	<ul style="list-style-type: none"> unbeschichtete Sorte für die Bearbeitung von Nichteisenmetalle empfohlen Titan, Messing, Kupfer, Silicium freies Aluminium, Kunststoff
<ul style="list-style-type: none"> very strong grade good wear resistance 1st choice for "high temperature" steels secondarily for stainless steels 	<ul style="list-style-type: none"> grade for non-ferrous materials very low friction ratio first choice for aluminium up to 5% Si, copper and low alloyed titanium 	<ul style="list-style-type: none"> uncoated grade recommended for machining of non-ferrous materials titanium, brass, bronze, aluminium without silicium, plastic

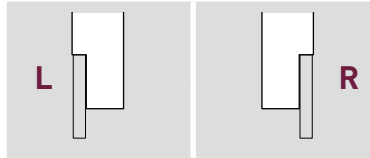
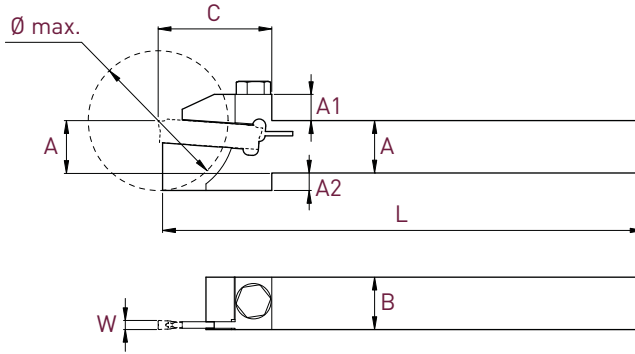

Plaquettes WSP Inserts	A x B x L	Ø max.	C	A1	A2	L		R		Pièces de rechange Ersatzteile Spare parts		
						Art. N°	Art. N°	Art. N°	Art. N°			
W 1.5	10x12x110	22	20	5	6	ET15-H1012L-D22	ET15-H1012R-D22	V-M5X20-6P6	C-6PEX-6.0	*	*	
	12x12x110	22	20	5	4	ET15-H1212L-D22	ET15-H1212R-D22					
	12.7x12.7x110	22	20	5	3	ET15-H12.7L-D22	ET15-H12.7R-D22					
Type ET15	12x12x110	32	26	6	4	ET15-H1212L-D32	ET15-H1212R-D32	V-M5X21-6P7	C-6PEX-7.0			
	12.7x12.7x110	32	26	6	3	ET15-H12.7L-D32	ET15-H12.7R-D32					
	16x16x110	32	26	6	-	ET15-H1616L-D32	ET15-H1616R-D32					
W 2.0	10x12x110	22	20	5	6	ET20-H1012L-D22	ET20-H1012R-D22	V-M5X20-6P6	C-6PEX-6.0			
	12x12x110	22	20	5	4	ET20-H1212L-D22	ET20-H1212R-D22					
	12.7x12.7x110	22	20	5	3	ET20-H12.7L-D22	ET20-H12.7R-D22					
	Type ET20	12x12x110	32	26	6	4	ET20-H1212L-D32	ET20-H1212R-D32	V-M5X21-6P7	C-6PEX-7.0		
		12.7x12.7x110	32	26	6	3	ET20-H12.7L-D32	ET20-H12.7R-D32				
		16x16x110	32	26	6	-	ET20-H1616L-D32	ET20-H1616R-D32				
16x16x130	44	35	8	4	ET20-H1616L-D44	ET20-H1616R-D44	V-M5X27-6P7	C-6PEX-7.0				
	20x20x130	44	35	8	-	ET20-H2020L-D44					ET20-H2020R-D44	
W 2.5	10x12x110	22	20	5	6	ET25-H1012L-D22	ET25-H1012R-D22	V-M5X20-6P6	C-6PEX-6.0			
	12x12x110	22	20	5	4	ET25-H1212L-D22	ET25-H1212R-D22					
	12.7x12.7x110	22	20	5	3	ET25-H12.7L-D22	ET25-H12.7R-D22					
Type ET25	12x12x110	32	26	6	4	ET25-H1212L-D32	ET25-H1212R-D32	V-M5X21-6P7	C-6PEX-7.0			
	12.7x12.7x110	32	26	6	3	ET25-H12.7L-D32	ET25-H12.7R-D32					
	16x16x110	32	26	6	-	ET25-H1616L-D32	ET25-H1616R-D32					
16x16x130	44	35	8	4	ET25-H1616L-D44	ET25-H1616R-D44	V-M5X27-6P7	C-6PEX-7.0				
	20x20x130	44	35	8	-	ET25-H2020L-D44					ET25-H2020R-D44	
W 3.0 Type ET30	16x16x110	32	26	6	-	ET30-H1616L-D32	ET30-H1616R-D32	V-M5X21-6P7	C-6PEX-7.0			
	16x16x130	44	35	8	4	ET30-H1616L-D44	ET30-H1616R-D44					
	20x20x130	44	35	8	-	ET30-H2020L-D44	ET30-H2020R-D44					

* livré avec chaque porte-outil
mit jedem Halter geliefert
delivered with each holder

Porte-outils avec arrosage intégré
 Halter mit integrierter Kühlmittelzufuhr
 Holders with integrated coolant supply

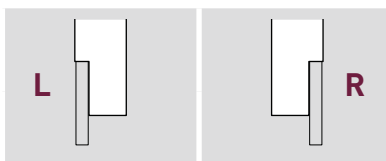
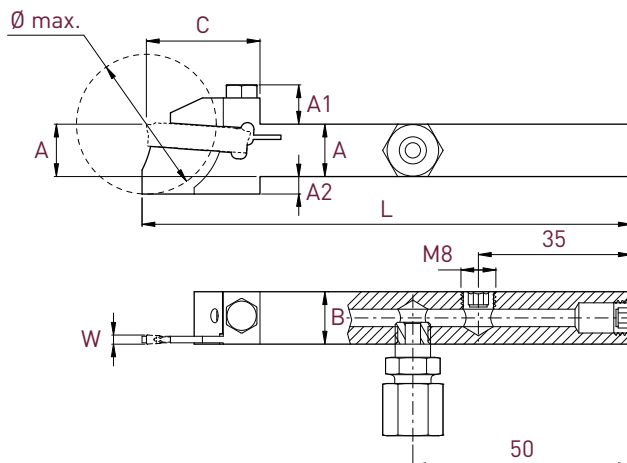

Ø max 44 m

H JET Series

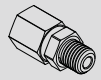

Pièces de rechange Ersatzteile Spare parts	
	
*	*
Art. N°	Art. N°
V-M5X20-6P6-J	C-6PEX-6.0
V-M5X21-6P7-J	C-6PEX-7.0
V-M5X27-6P7-J	C-6PEX-7.0
V-M5X20-6P6-J	C-6PEX-6.0
V-M5X21-6P7-J	C-6PEX-7.0
V-M5X27-6P7-J	C-6PEX-7.0
V-M5X21-6P7-J	C-6PEX-7.0
V-M5X27-6P7-J	C-6PEX-7.0

Plaquettes WSP Inserts	A x B x L	Ø max.	A1	C	A2	Art. N°	Art. N°
W 2.0 Type ET20	10x12x110	22	5	20	6	ET20-H1012L-JET22	ET20-H1012R-JET22
	12x12x110	22	5	20	4	ET20-H1212L-JET22	ET20-H1212R-JET22
	12.7x12.7x110	22	20	5	3	ET20-H12.7L-JET22	ET20-H12.7R-JET22
	12x12x110	32	6	26	4	ET20-H1212L-JET32	ET20-H1212R-JET32
	12.7x12.7x110	32	26	6	3	ET20-H12.7L-JET32	ET20-H12.7R-JET32
	16x16x110	32	6	26	-	ET20-H1616L-JET32	ET20-H1616R-JET32
W 2.5 Type ET25	16x16x130	44	8	35	4	ET20-H1616L-JET44	ET20-H1616R-JET44
	20x20x130	44	8	35	-	ET20-H2020L-JET44	ET20-H2020R-JET44
	10x12x110	22	5	20	6	ET25-H1012L-JET22	ET25-H1012R-JET22
	12x12x110	22	5	20	4	ET25-H1212L-JET22	ET25-H1212R-JET22
	12.7x12.7x110	22	20	5	3	ET25-H12.7L-JET22	ET25-H12.7R-JET22
	12x12x110	32	6	26	4	ET25-H1212L-JET32	ET25-H1212R-JET32
W 3.0 Type ET30	12.7x12.7x110	32	26	6	3	ET25-H12.7L-JET32	ET25-H12.7R-JET32
	16x16x110	32	6	26	-	ET25-H1616L-JET32	ET25-H1616R-JET32
	16x16x130	44	8	35	4	ET25-H1616L-JET44	ET25-H1616R-JET44
	20x20x130	44	8	35	-	ET25-H2020L-JET44	ET25-H2020R-JET44
	16x16x110	32	6	26	-	ET30-H1616L-JET32	ET30-H1616R-JET32
	16x16x130	44	8	35	4	ET30-H1616L-JET44	ET30-H1616R-JET44
20x20x130	44	8	35	-	ET30-H2020L-JET44	ET30-H2020R-JET44	

Pièces de rechange Ersatzteile Spare parts		
	Art. N°	Art. N°
	J-M8X1-D6	JB-M8X1

* Livré avec chaque porte-outil
 mit jedem Halter geliefert
 delivered with each holder

EVOCUT-LINE

Lames de tronçonnage



Stechklinge

Parting-off blades

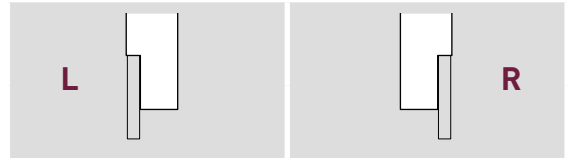
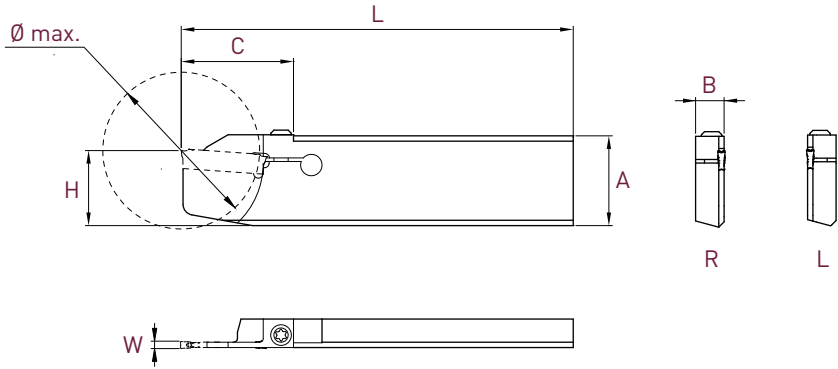
HK Series



Plaquettes WSP Inserts	A x B x L	Ø max.	C	H	Art. N°	Art. N°
W 1.5	26x8x110	20	19.5	21	ET15-HK-2608L-110-D20	ET15-HK-2608R-110-D20
Type ET15	26x8x110	32	25.5	21	ET15-HK-2608L-110-D32	ET15-HK-2608R-110-D32
W 2.0	26x8x110	32	25.5	21	ET20-HK-2608L-110-D32	ET20-HK-2608R-110-D32
Type ET20	26x8x110	44	31.5	21	ET20-HK-2608L-110-D44	ET20-HK-2608R-110-D44

Pièces de rechange Ersatzteile Spare parts	 *	 *
	Art. N°	Art. N°
	V-M4X14.5-T15-EVOCUT	C-T15

* livré avec chaque lame
mit jedem Stechkling geliefert
delivered with each blade

Lames de tronçonnage avec dégagement pour accès contre-broche

Stecklinge mit Aussparung für Gegenspindel Zugriff

Parting-off blades with recess for subspindle access

HK-RS Series

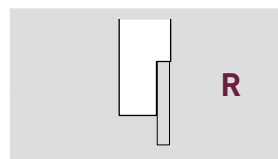
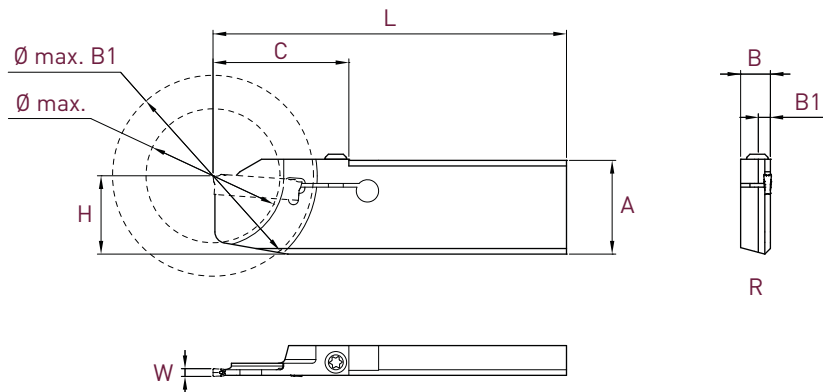

Plaquettes WSP Inserts	A x B x L	Ø max.	Ø max B1	B1	C	H	Art. N°
W 1.5 Type ET15	26x8x95	36	54	3.25	36.5	21	ET15-HK-2608RS-95-D36
W 2.0 Type ET20	26x8x95	36	54	3.25	36.5	21	ET20-HK-2608RS-95-D36

Pièces de rechange Ersatzteile Spare parts	 *	 *
	Art. N°	Art. N°
	V-M4X14.5-T15-EVOCUT	C-T15

* livré avec chaque lame
mit jedem Steckling geliefert
delivered with each blade



EVOCUT-LINE

Lames de tronçonnage inversées
 Überkopf Stechklinge
 Upside down parting-off blades

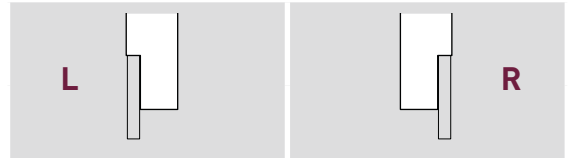
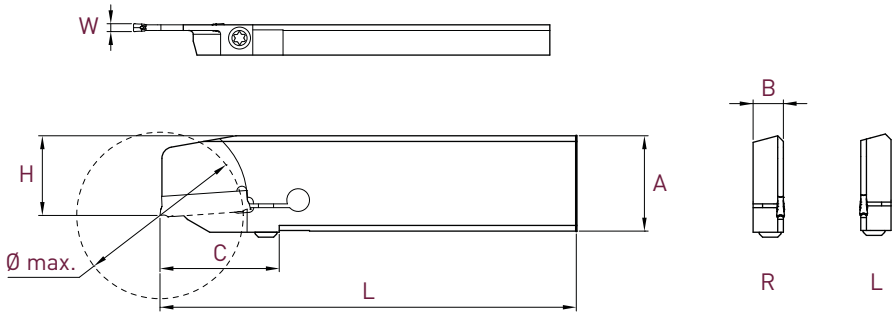
HUK Series



Plaquettes WSP Inserts	A x B x L	Ø max.	C	H	Art. N°	Art. N°
W 1.5	26x8x110	20	19.5	21	ET15-HUK-2608L-110-D20	ET15-HUK-2608R-110-D20
Type ET15	26x8x110	32	25.5	21	ET15-HUK-2608L-110-D32	ET15-HUK-2608R-110-D32
W 2.0	26x8x110	32	25.5	21	ET20-HUK-2608L-110-D32	ET20-HUK-2608R-110-D32
Type ET20	26x8x110	44	31.5	21	ET20-HUK-2608L-110-D44	ET20-HUK-2608R-110-D44

Pièces de rechange Ersatzteile Spare parts	 *	 *
	Art. N°	Art. N°
	V-M4X14.5-T15-EVOCUT	C-T15

* livré avec chaque lame
 mit jedem Steckling geliefert
 delivered with each blade

Lames pour système modulaire

Stechklinge für modulares System

Parting-off blades for modular system

HM Series

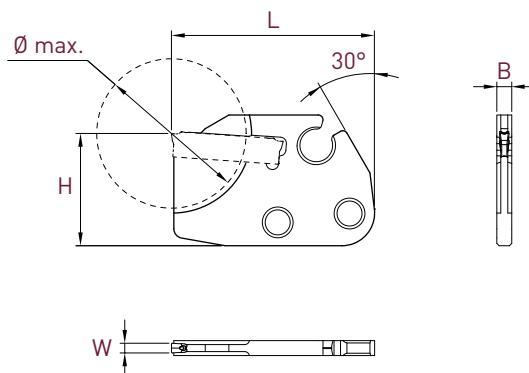

N

Plaquettes WSP Inserts	Ø max.	B	L	H	Art. N°
W 1.5	20	3.2	43.5	24	ET15-HM-IN-43-D20
Type ET15	32	3.2	43.5	24	ET15-HM-IN-43-D32
W 2.0	20	3.2	43.5	24	ET20-HM-IN-43-D20
	26	3.2	43.5	24	ET20-HM-IN-43-D26
Type ET20	26	3.2	54	24	ET20-HM-IN-54-D26
	32	3.2	43.5	24	ET20-HM-IN-43-D32
W 3.0					
Type ET20	32	3.2	43.5	24	ET30-HM-IN-43-D32

EVOCUT-LINE

Plaquettes de tronçonnage
 Abstechwendeplatten
 Cut off inserts

UN Series

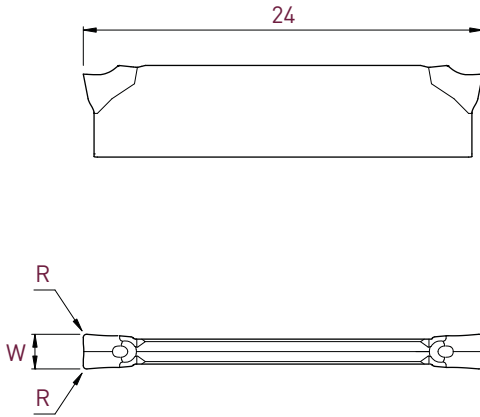

			UN 																					
Type	W $\pm 0,05$	R	Art. N°	<table border="1"> <tr> <td>P</td><td>P</td><td>P</td><td>P</td> </tr> <tr> <td>E</td><td>M</td><td>M</td><td>M</td> </tr> <tr> <td>N</td><td></td><td></td><td></td> </tr> <tr> <td>S</td><td></td><td></td><td></td> </tr> </table>	P	P	P	P	E	M	M	M	N				S				TiAlN	Tmax	Zmax	ZTi6
P	P	P	P																					
E	M	M	M																					
N																								
S																								
ET15	1.5	0	ET15-UN-000F	■																				
	1.5	0.2	ET15-UN-002	■	■	■																		
ET20	2.0	0	ET20-UN-000F	■																				
	2.0	0.2	ET20-UN-002	■	■	■	■	■																
ET25	2.5	0	ET25-UN-000F	■																				
	2.5	0.3	ET25-UN-003	■	■	■	■	■																
ET30	3.0	0	ET30-UN-000F	■																				
	3.0	0.3	ET30-UN-003	■	■	■	■	■																

Plaquettes de tronçonnage

Abstechwendeplatten

Cut off inserts

UL-UR Series

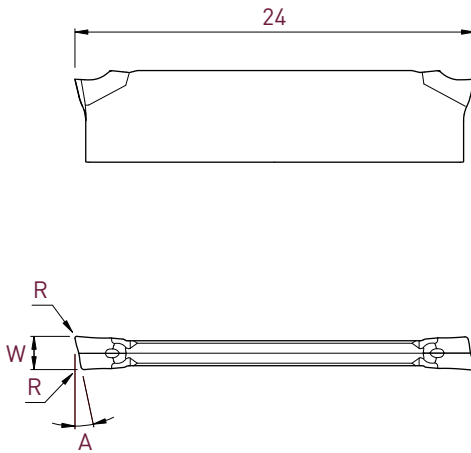

Type	W ±0,05	A	R	UL			UR				
				Art. N°	TiAlN	Tmax	Zmax	Art. N°	TiAlN	Tmax	Zmax
ET15	1.5	6°	0.2	-				ET15-UR-602	■	■	■
	1.5	8°	0	-				ET15-UR-800F	■		
	1.5	12°	0.1	-				ET15-UR-1201	■	■	■
	1.5	15°	0	ET15-UL-1500F	■			ET15-UR-1500F	■		
ET20	2.0	6°	0.2	-				ET20-UR-602	■	■	■
	2.0	8°	0	-				ET20-UR-800F	■		
	2.0	12°	0.1	-				ET20-UR-1201	■	■	■
	2.0	15°	0	ET20-UL-1500F	■			ET20-UR-1500F	■		
ET25	2.5	6°	0.2	-				ET25-UR-602	■	■	■
	2.5	8°	0	-				ET25-UR-800F	■		
	2.5	12°	0.1	-				ET25-UR-1201	■	■	■
	2.5	15°	0	ET25-UL-1500F	■			ET25-UR-1500F	■		
ET30	3.0	6°	0.3	-				ET30-UR-603	■	■	■
	3.0	8°	0	-				ET30-UR-800F	■		
	3.0	12°	0.2	-				ET30-UR-1202	■	■	■
	3.0	15°	0	ET30-UL-1500F	■			ET30-UR-1500F	■		

EVOCUT-LINE

- Plaquettes de tronçonnage
- Abstechwendeplatten
- Cut off inserts

JN Series

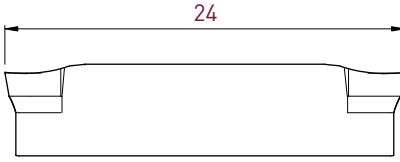

Type	W $\pm 0,05$	R	Art. N°	<table border="1"> <tr> <td><input type="checkbox"/></td><td><input type="checkbox"/></td><td><input type="checkbox"/></td><td><input type="checkbox"/></td> </tr> <tr> <td><input type="checkbox"/></td><td><input type="checkbox"/></td><td><input type="checkbox"/></td><td><input type="checkbox"/></td> </tr> <tr> <td><input type="checkbox"/></td><td><input type="checkbox"/></td><td><input type="checkbox"/></td><td><input type="checkbox"/></td> </tr> <tr> <td><input type="checkbox"/></td><td><input type="checkbox"/></td><td><input type="checkbox"/></td><td><input type="checkbox"/></td> </tr> </table>				<input type="checkbox"/>	<input type="checkbox"/>	<input type="checkbox"/>	<input type="checkbox"/>	<input type="checkbox"/>	<input type="checkbox"/>	<input type="checkbox"/>	<input type="checkbox"/>	<input type="checkbox"/>	<input type="checkbox"/>	<input type="checkbox"/>	<input type="checkbox"/>	<input type="checkbox"/>	<input type="checkbox"/>	<input type="checkbox"/>	<input type="checkbox"/>
				<input type="checkbox"/>	<input type="checkbox"/>	<input type="checkbox"/>	<input type="checkbox"/>																
<input type="checkbox"/>	<input type="checkbox"/>	<input type="checkbox"/>	<input type="checkbox"/>																				
<input type="checkbox"/>	<input type="checkbox"/>	<input type="checkbox"/>	<input type="checkbox"/>																				
<input type="checkbox"/>	<input type="checkbox"/>	<input type="checkbox"/>	<input type="checkbox"/>																				
TiAlN	Tmax	Zmax	ZTi6																				
ET15	1.5	0.2	ET15-JN-002	■	■	■																	
ET20	2.0	0.2	ET20-JN-002	■	■	■	■																
ET25	2.5	0.3	ET25-JN-003	■	■	■	■																
ET30	3.0	0.3	ET30-JN-003	■	■	■	■																

Plaquettes de tronçonnage

Abstechwendeplatten

Cut off inserts

JR Series

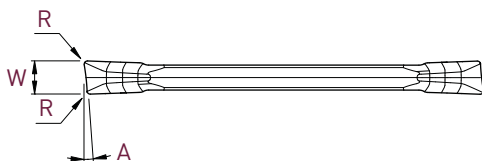
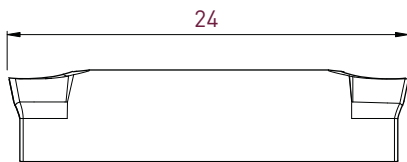

Type	W ±0,05	A	R	Art. N°	JR		
					TiAlN	Tmax	Zmax
ET15	1.5	6°	0.2	ET15-JR-602	<input checked="" type="checkbox"/>	<input checked="" type="checkbox"/>	<input checked="" type="checkbox"/>
ET20	2.0	6°	0.2	ET20-JR-602	<input checked="" type="checkbox"/>	<input checked="" type="checkbox"/>	<input checked="" type="checkbox"/>
ET25	2.5	6°	0.2	ET25-JR-602	<input checked="" type="checkbox"/>	<input checked="" type="checkbox"/>	<input checked="" type="checkbox"/>
ET30	3.0	6°	0.3	ET30-JR-603	<input checked="" type="checkbox"/>	<input checked="" type="checkbox"/>	<input checked="" type="checkbox"/>

EVOCUT-LINE

- Plaquettes de tronçonnage
- Abstechwendeplatten
- Cut off inserts

Negative geometry

TN Series

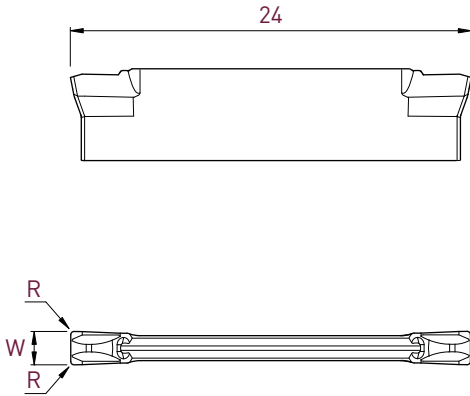

			TN 																																																			
Type	W $\pm 0,05$	R	Art. N°	<table border="1" style="font-size: 8px;"> <tr> <td><input type="checkbox"/></td><td><input type="checkbox"/></td><td><input type="checkbox"/></td><td><input type="checkbox"/></td> </tr> <tr> <td><input type="checkbox"/></td><td><input type="checkbox"/></td><td><input type="checkbox"/></td><td><input type="checkbox"/></td> </tr> <tr> <td><input type="checkbox"/></td><td><input type="checkbox"/></td><td><input type="checkbox"/></td><td><input type="checkbox"/></td> </tr> <tr> <td><input type="checkbox"/></td><td><input type="checkbox"/></td><td><input type="checkbox"/></td><td><input type="checkbox"/></td> </tr> </table>	<input type="checkbox"/>	<input type="checkbox"/>	<input type="checkbox"/>	<input type="checkbox"/>	<input type="checkbox"/>	<input type="checkbox"/>	<input type="checkbox"/>	<input type="checkbox"/>	<input type="checkbox"/>	<input type="checkbox"/>	<input type="checkbox"/>	<input type="checkbox"/>	<input type="checkbox"/>	<input type="checkbox"/>	<input type="checkbox"/>	<input type="checkbox"/>	<table border="1" style="font-size: 8px;"> <tr> <td><input type="checkbox"/></td><td><input type="checkbox"/></td><td><input type="checkbox"/></td><td><input type="checkbox"/></td> </tr> <tr> <td><input type="checkbox"/></td><td><input type="checkbox"/></td><td><input type="checkbox"/></td><td><input type="checkbox"/></td> </tr> <tr> <td><input type="checkbox"/></td><td><input type="checkbox"/></td><td><input type="checkbox"/></td><td><input type="checkbox"/></td> </tr> <tr> <td><input type="checkbox"/></td><td><input type="checkbox"/></td><td><input type="checkbox"/></td><td><input type="checkbox"/></td> </tr> </table>	<input type="checkbox"/>	<input type="checkbox"/>	<input type="checkbox"/>	<input type="checkbox"/>	<input type="checkbox"/>	<input type="checkbox"/>	<input type="checkbox"/>	<input type="checkbox"/>	<input type="checkbox"/>	<input type="checkbox"/>	<input type="checkbox"/>	<input type="checkbox"/>	<input type="checkbox"/>	<input type="checkbox"/>	<input type="checkbox"/>	<input type="checkbox"/>	<table border="1" style="font-size: 8px;"> <tr> <td><input type="checkbox"/></td><td><input type="checkbox"/></td><td><input type="checkbox"/></td><td><input type="checkbox"/></td> </tr> <tr> <td><input type="checkbox"/></td><td><input type="checkbox"/></td><td><input type="checkbox"/></td><td><input type="checkbox"/></td> </tr> <tr> <td><input type="checkbox"/></td><td><input type="checkbox"/></td><td><input type="checkbox"/></td><td><input type="checkbox"/></td> </tr> <tr> <td><input type="checkbox"/></td><td><input type="checkbox"/></td><td><input type="checkbox"/></td><td><input type="checkbox"/></td> </tr> </table>	<input type="checkbox"/>	<input type="checkbox"/>	<input type="checkbox"/>	<input type="checkbox"/>	<input type="checkbox"/>	<input type="checkbox"/>	<input type="checkbox"/>	<input type="checkbox"/>	<input type="checkbox"/>	<input type="checkbox"/>	<input type="checkbox"/>	<input type="checkbox"/>	<input type="checkbox"/>	<input type="checkbox"/>	<input type="checkbox"/>	<input type="checkbox"/>
<input type="checkbox"/>	<input type="checkbox"/>	<input type="checkbox"/>	<input type="checkbox"/>																																																			
<input type="checkbox"/>	<input type="checkbox"/>	<input type="checkbox"/>	<input type="checkbox"/>																																																			
<input type="checkbox"/>	<input type="checkbox"/>	<input type="checkbox"/>	<input type="checkbox"/>																																																			
<input type="checkbox"/>	<input type="checkbox"/>	<input type="checkbox"/>	<input type="checkbox"/>																																																			
<input type="checkbox"/>	<input type="checkbox"/>	<input type="checkbox"/>	<input type="checkbox"/>																																																			
<input type="checkbox"/>	<input type="checkbox"/>	<input type="checkbox"/>	<input type="checkbox"/>																																																			
<input type="checkbox"/>	<input type="checkbox"/>	<input type="checkbox"/>	<input type="checkbox"/>																																																			
<input type="checkbox"/>	<input type="checkbox"/>	<input type="checkbox"/>	<input type="checkbox"/>																																																			
<input type="checkbox"/>	<input type="checkbox"/>	<input type="checkbox"/>	<input type="checkbox"/>																																																			
<input type="checkbox"/>	<input type="checkbox"/>	<input type="checkbox"/>	<input type="checkbox"/>																																																			
<input type="checkbox"/>	<input type="checkbox"/>	<input type="checkbox"/>	<input type="checkbox"/>																																																			
<input type="checkbox"/>	<input type="checkbox"/>	<input type="checkbox"/>	<input type="checkbox"/>																																																			
ET20	2.0	0.2	ET20-TN-002	■	■	■	■																																															
ET25	2.5	0.3	ET25-TN-003	■	■	■	■																																															
ET30	3.0	0.3	ET30-TN-003	■	■	■	■																																															

Plaquettes de tronçonnage

Abstechwendeplatten

Cut off inserts

Negative geometry

TR Series

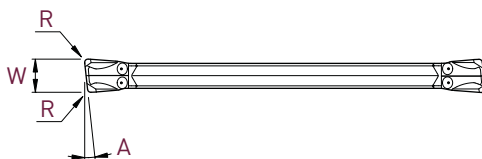
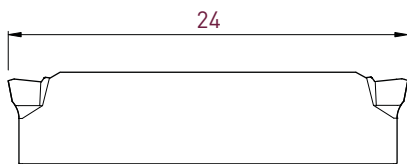

				TR																	
Type	W $\pm 0,05$	A	R	Art. N°	<table border="1"> <tr> <td><input type="checkbox"/></td><td><input type="checkbox"/></td><td><input type="checkbox"/></td><td><input type="checkbox"/></td> </tr> <tr> <td><input type="checkbox"/></td><td><input type="checkbox"/></td><td><input type="checkbox"/></td><td><input type="checkbox"/></td> </tr> <tr> <td><input type="checkbox"/></td><td><input type="checkbox"/></td><td><input type="checkbox"/></td><td><input type="checkbox"/></td> </tr> <tr> <td><input type="checkbox"/></td><td><input type="checkbox"/></td><td><input type="checkbox"/></td><td><input type="checkbox"/></td> </tr> </table>	<input type="checkbox"/>	<input type="checkbox"/>	<input type="checkbox"/>	<input type="checkbox"/>	<input type="checkbox"/>	<input type="checkbox"/>	<input type="checkbox"/>	<input type="checkbox"/>	<input type="checkbox"/>	<input type="checkbox"/>	<input type="checkbox"/>	<input type="checkbox"/>	<input type="checkbox"/>	<input type="checkbox"/>	<input type="checkbox"/>	<input type="checkbox"/>
<input type="checkbox"/>	<input type="checkbox"/>	<input type="checkbox"/>	<input type="checkbox"/>																		
<input type="checkbox"/>	<input type="checkbox"/>	<input type="checkbox"/>	<input type="checkbox"/>																		
<input type="checkbox"/>	<input type="checkbox"/>	<input type="checkbox"/>	<input type="checkbox"/>																		
<input type="checkbox"/>	<input type="checkbox"/>	<input type="checkbox"/>	<input type="checkbox"/>																		
ET20	2.0	6°	0.2	ET20-TR-602	<table border="1"> <tr> <td><input checked="" type="checkbox"/></td><td><input checked="" type="checkbox"/></td><td><input checked="" type="checkbox"/></td><td><input checked="" type="checkbox"/></td> </tr> <tr> <td><input type="checkbox"/></td><td><input type="checkbox"/></td><td><input type="checkbox"/></td><td><input type="checkbox"/></td> </tr> <tr> <td><input type="checkbox"/></td><td><input type="checkbox"/></td><td><input type="checkbox"/></td><td><input type="checkbox"/></td> </tr> <tr> <td><input type="checkbox"/></td><td><input type="checkbox"/></td><td><input type="checkbox"/></td><td><input type="checkbox"/></td> </tr> </table>	<input checked="" type="checkbox"/>	<input checked="" type="checkbox"/>	<input checked="" type="checkbox"/>	<input checked="" type="checkbox"/>	<input type="checkbox"/>	<input type="checkbox"/>	<input type="checkbox"/>	<input type="checkbox"/>	<input type="checkbox"/>	<input type="checkbox"/>	<input type="checkbox"/>	<input type="checkbox"/>	<input type="checkbox"/>	<input type="checkbox"/>	<input type="checkbox"/>	<input type="checkbox"/>
<input checked="" type="checkbox"/>	<input checked="" type="checkbox"/>	<input checked="" type="checkbox"/>	<input checked="" type="checkbox"/>																		
<input type="checkbox"/>	<input type="checkbox"/>	<input type="checkbox"/>	<input type="checkbox"/>																		
<input type="checkbox"/>	<input type="checkbox"/>	<input type="checkbox"/>	<input type="checkbox"/>																		
<input type="checkbox"/>	<input type="checkbox"/>	<input type="checkbox"/>	<input type="checkbox"/>																		
ET25	2.5	6°	0.2	ET25-TR-602	<table border="1"> <tr> <td><input checked="" type="checkbox"/></td><td><input checked="" type="checkbox"/></td><td><input checked="" type="checkbox"/></td><td><input checked="" type="checkbox"/></td> </tr> <tr> <td><input type="checkbox"/></td><td><input type="checkbox"/></td><td><input type="checkbox"/></td><td><input type="checkbox"/></td> </tr> <tr> <td><input type="checkbox"/></td><td><input type="checkbox"/></td><td><input type="checkbox"/></td><td><input type="checkbox"/></td> </tr> <tr> <td><input type="checkbox"/></td><td><input type="checkbox"/></td><td><input type="checkbox"/></td><td><input type="checkbox"/></td> </tr> </table>	<input checked="" type="checkbox"/>	<input checked="" type="checkbox"/>	<input checked="" type="checkbox"/>	<input checked="" type="checkbox"/>	<input type="checkbox"/>	<input type="checkbox"/>	<input type="checkbox"/>	<input type="checkbox"/>	<input type="checkbox"/>	<input type="checkbox"/>	<input type="checkbox"/>	<input type="checkbox"/>	<input type="checkbox"/>	<input type="checkbox"/>	<input type="checkbox"/>	<input type="checkbox"/>
<input checked="" type="checkbox"/>	<input checked="" type="checkbox"/>	<input checked="" type="checkbox"/>	<input checked="" type="checkbox"/>																		
<input type="checkbox"/>	<input type="checkbox"/>	<input type="checkbox"/>	<input type="checkbox"/>																		
<input type="checkbox"/>	<input type="checkbox"/>	<input type="checkbox"/>	<input type="checkbox"/>																		
<input type="checkbox"/>	<input type="checkbox"/>	<input type="checkbox"/>	<input type="checkbox"/>																		
ET30	3.0	6°	0.3	ET30-TR-603	<table border="1"> <tr> <td><input checked="" type="checkbox"/></td><td><input checked="" type="checkbox"/></td><td><input checked="" type="checkbox"/></td><td><input checked="" type="checkbox"/></td> </tr> <tr> <td><input type="checkbox"/></td><td><input type="checkbox"/></td><td><input type="checkbox"/></td><td><input type="checkbox"/></td> </tr> <tr> <td><input type="checkbox"/></td><td><input type="checkbox"/></td><td><input type="checkbox"/></td><td><input type="checkbox"/></td> </tr> <tr> <td><input type="checkbox"/></td><td><input type="checkbox"/></td><td><input type="checkbox"/></td><td><input type="checkbox"/></td> </tr> </table>	<input checked="" type="checkbox"/>	<input checked="" type="checkbox"/>	<input checked="" type="checkbox"/>	<input checked="" type="checkbox"/>	<input type="checkbox"/>	<input type="checkbox"/>	<input type="checkbox"/>	<input type="checkbox"/>	<input type="checkbox"/>	<input type="checkbox"/>	<input type="checkbox"/>	<input type="checkbox"/>	<input type="checkbox"/>	<input type="checkbox"/>	<input type="checkbox"/>	<input type="checkbox"/>
<input checked="" type="checkbox"/>	<input checked="" type="checkbox"/>	<input checked="" type="checkbox"/>	<input checked="" type="checkbox"/>																		
<input type="checkbox"/>	<input type="checkbox"/>	<input type="checkbox"/>	<input type="checkbox"/>																		
<input type="checkbox"/>	<input type="checkbox"/>	<input type="checkbox"/>	<input type="checkbox"/>																		
<input type="checkbox"/>	<input type="checkbox"/>	<input type="checkbox"/>	<input type="checkbox"/>																		

EVOCUT-LINE

Plaquettes de tronçonnage

Abstechwendeplatten

Cut off inserts

AN Series

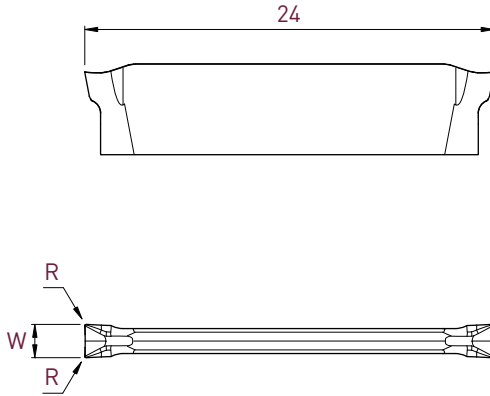

			AN			
Type	W $\pm 0,05$	R	Art. N°	TiAIN	AS	N
ET20	2.0	0.2	ET20-AN-002F	<input checked="" type="checkbox"/>	<input checked="" type="checkbox"/>	<input checked="" type="checkbox"/>
ET30	3.0	0.3	ET30-AN-003F	<input checked="" type="checkbox"/>	<input checked="" type="checkbox"/>	<input checked="" type="checkbox"/>

Plaquettes de tronçonnage

Abstechwendeplatten

Cut off inserts

AR Series

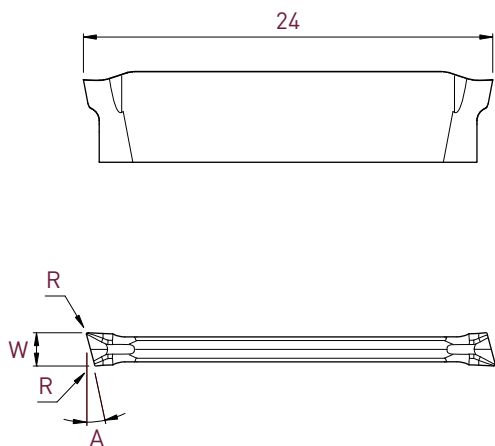









				AR			
Type	W $\pm 0,05$	A	R	Art. N°	TiAIN	AS	N
ET20	2.0	15°	0.1	ET20-AR-1501F	<input checked="" type="checkbox"/>	<input checked="" type="checkbox"/>	<input checked="" type="checkbox"/>
ET30	3.0	15°	0.2	ET30-AR-1502F	<input checked="" type="checkbox"/>	<input checked="" type="checkbox"/>	<input checked="" type="checkbox"/>

EVOCUT-LINE

Paramètres de coupe indicatifs

Empfohlene Schnittwerte

Standard machining data

						Acier Stahl Steel						Inox Rostfreistahl Stainless steel		
		ET15	ET20	ET25	ET30	Acier de décolletage Automatenstahl Free-cutting steel		Acier faiblement allié Leicht legierter Stahl Low alloyed steel		Acier fortement allié Legierter Stahl High alloyed steel		Austenitique et martensitique Austenitic and martensitic		
		VC (m/min)	F (mm/U)	VC (m/min)	F (mm/U)	VC (m/min)	F (mm/U)	VC (m/min)	F (mm/U)	VC (m/min)	F (mm/U)			
Avance standard Standard Vorschub Standard feed rate	UN 	TiAlN	■	■	■	■	90-140	0.04-0.08	60-120	0.04-0.08	50-100	0.04-0.08	50-120	0.04-0.08
		Tmax	■	■	■	■	100-170	0.04-0.08	70-150	0.04-0.08	60-120	0.04-0.08	60-150	0.04-0.08
		Zmax	■	■	■	■	80-130*	0.04-0.10	50-110*	0.04-0.10	50-90*	0.04-0.10	50-120*	0.04-0.10
		ZTi6	■	■	■	■	110-200	0.04-0.08	80-160	0.04-0.08	70-140	0.04-0.08	70-160	0.04-0.08
	UR 	TiAlN	■	■	■	■	90-140	0.04-0.08	60-120	0.04-0.08	50-100	0.04-0.08	50-120	0.04-0.08
		Tmax	■	■	■	■	100-170	0.04-0.08	70-150	0.04-0.08	60-120	0.04-0.08	60-150	0.04-0.08
		Zmax	■	■	■	■	80-130*	0.04-0.10	50-110*	0.04-0.10	50-90*	0.04-0.10	50-120*	0.04-0.10
		ZTi6	■	■	■	■	110-200	0.04-0.08	80-160	0.04-0.08	70-140	0.04-0.08	70-160	0.04-0.08
	JN 	TiAlN	■	■	■	■	90-140	0.04-0.08	60-120	0.04-0.08	50-100	0.04-0.08	50-120	0.04-0.08
		Tmax	■	■	■	■	100-170	0.04-0.08	70-150	0.04-0.08	60-120	0.04-0.08	60-150	0.04-0.08
		Zmax	■	■	■	■	80-130*	0.04-0.10	50-110*	0.04-0.10	50-90*	0.04-0.10	50-120*	0.04-0.10
		ZTi6	■	■	■	■	110-200	0.04-0.08	80-160	0.04-0.08	70-140	0.04-0.08	70-160	0.04-0.08
	JR 	TiAlN	■	■	■	■	90-140	0.04-0.08	60-120	0.04-0.08	50-100	0.04-0.08	50-120	0.04-0.08
		Tmax	■	■	■	■	100-170	0.04-0.08	70-150	0.04-0.08	60-120	0.04-0.08	60-150	0.04-0.08
		Zmax	■	■	■	■	80-130*	0.04-0.10	50-110*	0.04-0.10	50-90*	0.04-0.10	50-120*	0.04-0.10
		ZTi6	■	■	■	■	110-200	0.04-0.08	80-160	0.04-0.08	70-140	0.04-0.08	70-160	0.04-0.08
	TN 	TiAlN	■	■	■	■	90-150	0.08-0.18	70-130	0.08-0.18	50-100	0.08-0.15	50-120	0.08-0.20
		Tmax	■	■	■	■	100-170	0.08-0.18	70-150	0.08-0.18	60-120	0.08-0.15	60-150	0.08-0.20
		Zmax	■	■	■	■	80-130*	0.08-0.18	50-110*	0.08-0.18	50-90*	0.08-0.15	50-120*	0.08-0.20
		ZTi6	■	■	■	■	110-200	0.08-0.18	80-160	0.08-0.18	70-140	0.08-0.15	70-160	0.08-0.20
	TR 	TiAlN	■	■	■	■	90-150	0.08-0.18	70-130	0.08-0.18	50-100	0.08-0.15	50-120	0.08-0.20
		Tmax	■	■	■	■	100-170	0.08-0.18	70-150	0.08-0.18	60-120	0.08-0.15	60-150	0.08-0.20
		Zmax	■	■	■	■	80-130*	0.08-0.18	50-110*	0.08-0.18	50-90*	0.08-0.15	50-120*	0.08-0.20
		ZTi6	■	■	■	■	110-200	0.08-0.18	80-160	0.08-0.18	70-140	0.08-0.15	70-160	0.08-0.20
Avance modérée Niedriger Vorschub Low feed rate	UN-000F 	TiAlN	■	■	■	■	80-120	0.02-0.05	50-100	0.02-0.05	40-80	0.02-0.05	40-100	0.02-0.05
		UR/UL	TiAlN	■	■	■	■	80-120	0.02-0.05	50-100	0.02-0.05	40-80	0.02-0.05	40-100
	AN 	N	■	■	■	■								
		TiAlN	■	■	■	■							40-80	0.02-0.05
	AR 	AS	■	■	■	■								
		N	■	■	■	■								
		TiAlN	■	■	■	■							40-80	0.02-0.05
			AS	■	■	■								

* premier choix en cas de coupe interrompue

** arête de coupe vive

* beste Basis für unterbrochene Schnitte

** scharfe Schneidkante

* first choice for interrupted cut

** sharp cutting edge

N Alliage d'aluminium et non ferreux Aluminium- und Nichteisenlegierungen Aluminium and non-ferrous alloys								S Titane Titan Titanium			
Aluminium		Alu silicium max. 5% Aluminiumsilicium max. 5% Aluminium silicon max. 5%		Cuivre Kupfer Copper		Laiton & bronze Messing & Bronze Brass & bronze		Gr. 1 - 3		Gr. 4 - 5	
VC (m/min)	F (mm/U)	VC (m/min)	F (mm/U)	VC (m/min)	F (mm/U)	VC (m/min)	F (mm/U)	VC (m/min)	F (mm/U)	VC (m/min)	F (mm/U)
100-250	0.03-0.10	100-250	0.03-0.10	100-300	0.03-0.10	100-300	0.03-0.10			50-100	0.04-0.08
100-250	0.03-0.10	100-250	0.03-0.10	100-300	0.03-0.10	100-300	0.03-0.10			50-100	0.04-0.08
100-250	0.03-0.10	100-250	0.03-0.10	100-300	0.03-0.10	100-300	0.03-0.10			50-100	0.04-0.08
100-250	0.03-0.10	100-250	0.03-0.10	100-300	0.03-0.10	100-300	0.03-0.10			50-100	0.04-0.08
						150-300	0.05-0.20				
						150-300	0.05-0.20				
100-300	0.02-0.06	100-200	0.01-0.05	100-250	0.01-0.05	100-300	0.02-0.06			50-100	0.01-0.06
100-300	0.02-0.06	100-200	0.01-0.05	100-250	0.01-0.05	100-300	0.02-0.06			50-100	0.01-0.06
80-200	0.02-0.06			80-200	0.01-0.05	80-200	0.02-0.06	50-100	0.01-0.06	50-100	0.01-0.06
100-250	0.02-0.06	80-150	0.01-0.05	100-200	0.01-0.05	80-200	0.02-0.06			30-80	0.01-0.06
100-300	0.02-0.06	100-200	0.01-0.05	100-250	0.01-0.05	100-300	0.02-0.06	50-120	0.01-0.06	50-120	0.01-0.06
80-200	0.02-0.06			80-200	0.01-0.05	80-200	0.02-0.06	50-100	0.01-0.06	50-100	0.01-0.06
100-250	0.02-0.06	80-150	0.01-0.05	100-200	0.01-0.05	80-200	0.02-0.06			30-80	0.01-0.06
100-300	0.02-0.06	100-200	0.01-0.05	100-250	0.01-0.05	100-300	0.02-0.06	50-120	0.01-0.06	50-120	0.01-0.06



CUT-LINE

APPLITEC

Porte-outils / Halter / Holders

H

Système de serrage à bride, version courte
Spannbrücke Klemmsystem, kurze Ausführung
Independent top clamp system, short version

HX

Système de serrage à bride, version longue
Spannbrücke Klemmsystem, lange Ausführung
Independent top clamp system, long version

HZ

Porte-outils de grande capacité
Klemmhalter für grössere Durchmesser
High capacity tool holders

Very rigid clamping system!

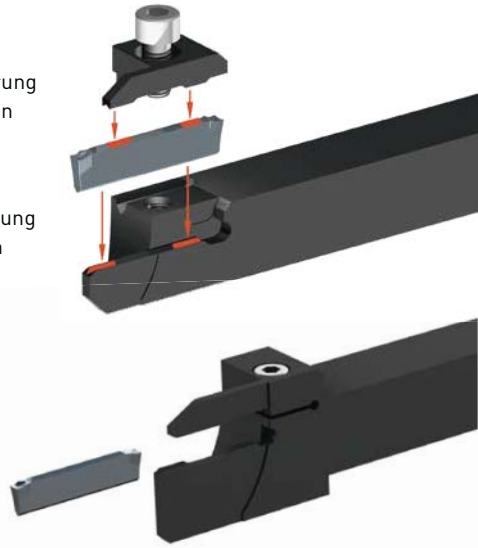

Plaquettes / WSP / Inserts

CUT 16

=

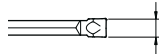

1.6 mm

Ø max 20 mm

CUT 22

=

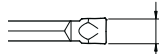

2.2 mm

Ø max 42 mm

CUT 31

=

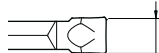

3.1 mm

Ø max 65 mm



U



P



T



G

Nuances et géométries
Sorten und Geometrien > **9.02**
Grades and types of geometries

CUT 16 Ø max 20 mm > **9.04**

Paramètres de coupe indicatifs
Empfohlene Schnittwerte > **9.06**
Standard machining data

CUT 31 Ø max 65 mm > **9.08**

H Series > **9.10**

Porte-outils
Halter > **9.11**
Holders

HZ Series > **9.12**

Porte-outils avec arrosage intégré
Halter mit integrierter Kühlmittelzufuhr > **9.13**
Holders with integrated coolant supply

U Series > **9.14**

Plaquettes de tronçonnage
Abstechwendeplatten > **9.16**
Cut off inserts

T Series > **9.20**

Plaquettes de fonçage, tournage et tronçonnage
WSP zum einstecken, drehen und abstechen > **9.21**
Inserts for grooving, turning and cut off

<h3>TiAlN</h3> <p>revêtement PVD PVD Beschichtung PVD coating</p>	<h3>Tmax</h3> <p>revêtement PVD PVD Beschichtung PVD coating</p>	<h3>Zmax</h3> <p>revêtement PVD PVD Beschichtung PVD coating</p>
<ul style="list-style-type: none"> pour l'usinage des aciers, aciers inoxydables et alliages de titane 1^{er} choix pour les avances faibles à modérées 	<ul style="list-style-type: none"> nuance pour usinage moyen à lourd des aciers, aciers alliés et inoxydables bonne résistance aux températures d'usinage élevées 1^{er} choix pour le tronçonnage des aciers au carbone et des aciers fortement alliés 	<ul style="list-style-type: none"> pour l'usinage des aciers, aciers inoxydables et alliages de titane en conditions défavorables bonne résistance aux chocs à des vitesses de coupe moyenne à faible 1^{er} choix pour le tronçonnage en coupe interrompue
<ul style="list-style-type: none"> für die Bearbeitung von Stahl, rostfreiem Stahl und Titanlegierungen beste Wahl für niedrige bis mittlere Vorschübe 	<ul style="list-style-type: none"> Sorte für mittlere bis hohe Belastung in Stahl und legierter Stahlbearbeitung gute Bearbeitungswarmfestigkeit für die Bearbeitung von legiertem Kohlenstahl und hoch legiertem Stahl bestens geeignet 	<ul style="list-style-type: none"> für die Bearbeitung von Stahl, rostfreiem Stahl und Titanlegierungen in schwierige Bearbeitungsfälle gute Bruchfestigkeit mit durchschnittliche bis niedrige Schnittgeschwindigkeit für die Bearbeitung in unterbrochenen Schnitte bestens geeignet
<ul style="list-style-type: none"> for machining of steel, stainless steel and titanium alloys first choice for low to average cutting speed 	<ul style="list-style-type: none"> grade for medium to heavy machining of steel, stainless steel and alloyed steel high machining heat resistance first choice for the machining of carbon steel and high alloyed steel 	<ul style="list-style-type: none"> for machining of steel, stainless steel and titanium alloys in unfavourable machining conditions good impact resistance with average to low cutting speed first choice for machining in interrupted cut

<h3>HTA</h3> <p>revêtement PVD PVD Beschichtung PVD coating</p>	<h3>AS</h3> <p>revêtement PVD PVD Beschichtung PVD coating</p>	<h3>N</h3> <p>non revêtu unbeschichtet uncoated</p>
<ul style="list-style-type: none"> très bonne résistance à l'usure pour le tronçonnage des aciers, aciers inoxydables et alliages de titane déconseillé en coupe interrompue 	<ul style="list-style-type: none"> nuance pour métaux non ferreux très faible coefficient de frottement 1^{er} choix pour l'usinage des aluminiums jusqu'à 5% Si, des cuivres et titanes faiblement alliés 	<ul style="list-style-type: none"> nuance pour les laitons, pour la géométrie PNW et PRW
<ul style="list-style-type: none"> sehr gute Verschleissfestigkeit für die Bearbeitung von Stahl, rostfreiem Stahl und Titanlegierung bestens geeignet für unterbrochene Schnitte ungeeignet 	<ul style="list-style-type: none"> Sorte für Nichteisenmetalle sehr geringer Reibwert für die Bearbeitung von Aluminium bis 5% Si, Kupfer und niedriglegiertem Titan bestens geeignet 	<ul style="list-style-type: none"> Sorte für Messing, für PNW und PRW Geometrie
<ul style="list-style-type: none"> very good wear resistance first choice for steel, stainless steel and titanium alloys machining not suitable for interrupted cut 	<ul style="list-style-type: none"> grade for non-ferrous materials very low friction ratio first choice for Aluminium up to 5% Si, copper and low alloyed titanium 	<ul style="list-style-type: none"> grade for brass, for PNW and PRW geometry

Géométries de coupe

Spanformgeometrie

Cutting geometries

UN

UR
UL

- géométrie positive universelle, bonne maîtrise du copeau
- allgemeine Geometrie, sehr gute Spankontrolle
- all-round insert with efficient chip control

PN

PR

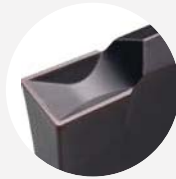

- géométrie légèrement positive pour les aciers, aciers au carbone, aciers alliés
- leicht positive Geometrie für Stahl, Kohlenstoffstahl, legiertem Stahl
- slightly positive geometry for steel, carbon steel, alloyed steel

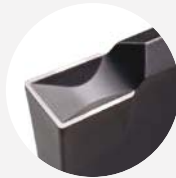
PNW
PRW

- géométrie neutre pour les laiton
- neutrale Geometrie für Messing
- neutral geometry for brasses

TN



- géométrie négative pour de fortes avances dans des conditions de rigidité favorable
- negative Geometrie für hohe Vorschübe in guten Stabilitätsfällen
- negative geometry for high feed rate in case of good stability

GN



- géométrie universelle pour fonçage-tournage, peut également être utilisée en tronçonnage
- allgemeine Geometrie zum einstecken-langdrehen, kann auch zum abstechen verwendet werden
- all-round insert for grooving and turning, can also be used for parting off





CUT-LINE

Paramètres de coupe indicatifs

Empfohlene Schnittwerte

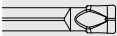
Standard machining data

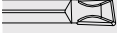
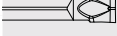
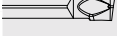
CUT 16

		P Acier Stahl Steel						M Inox Rostfreistahl Stainless steel		
		Acier de décolletage Automatenstahl Free-cutting steel		Acier faiblement allié Leicht legierter Stahl Low alloyed steel		Acier fortement allié Legierter Stahl High alloyed steel		Austénitique et martensitique Austenitisch und martensitisch Austenitic and martensitic		
		VC (m/min)	F (mm/U)	VC (m/min)	F (mm/U)	VC (m/min)	F (mm/U)	VC (m/min)	F (mm/U)	
Avance standard Standard Vorschub Standard feed rate	CUT16-UN-001 	TiAlN	90-140	0.03-0.07	60-120	0.03-0.07	50-100	0.04-0.08	50-120	0.03-0.07
		Tmax	100-170	0.03-0.07	70-150	0.03-0.07	60-120	0.04-0.08	60-150	0.03-0.07
		Zmax	80-130*	0.04-0.10	50-110*	0.04-0.10	50-90*	0.04-0.08	50-120*	0.04-0.10
		HTA	70-120	0.03-0.05	60-100	0.03-0.05	50-90	0.03-0.05	50-100	0.03-0.06
		AS								
	CUT16-PR-801 	TiAlN	90-140	0.03-0.07	60-120	0.03-0.07	50-100	0.03-0.07	50-120	0.03-0.07
	Tmax	100-170	0.03-0.07	70-150	0.03-0.07	60-120	0.03-0.07	60-150	0.03-0.07	
CUT16-PRW-801 	N									
Avance modérée Niedriger Vorschub Low feed rate	CUT16-UN-000F 	TiAlN	80-130	0.02-0.05	50-110	0.02-0.05	50-90	0.02-0.05	50-80	0.02-0.05
		HTA	60-100	0.01-0.04	50-90	0.01-0.04	50-80	0.02-0.05	50-80	0.02-0.05
		AS								
	CUT16-UL/R-800F 	TiAlN	80-130	0.02-0.05	50-110	0.02-0.05	50-90	0.02-0.05	50-80	0.02-0.05
		HTA	60-100	0.01-0.04	50-90	0.01-0.04	50-80	0.02-0.05	50-80	0.02-0.05
		AS								
	CUT16-UL/R-1500F 	TiAlN	80-130	0.02-0.05	50-110	0.02-0.05	50-90	0.02-0.05	50-80	0.02-0.05
		HTA	60-100	0.01-0.04	50-90	0.01-0.04	50-80	0.02-0.05	50-80	0.02-0.05
		AS								

** arête de coupe vive

** scharfe Schneidkante

** sharp cutting edge

N Alliage d'aluminium et non ferreux Aluminium- und Nichteisenlegierungen Aluminium and non-ferrous alloys								S Titane Titan Titanium			
Aluminium		Alu silicium max. 5% Aluminiumsilicium max. 5% Aluminium silicon max. 5%		Cuivre Kupfer Copper		Laiton & bronze Messing & Bronze Brass & bronze		Gr. 1 - 3		Gr. 4 - 5	
VC (m/min)	F (mm/U)	VC (m/min)	F (mm/U)	VC (m/min)	F (mm/U)	VC (m/min)	F (mm/U)	VC (m/min)	F (mm/U)	VC (m/min)	F (mm/U)
100-250	0.03-0.10	100-250	0.03-0.10	100-300	0.03-0.10	100-300	0.03-0.10			30-60	0.04-0.08
100-300	0.04-0.10	100-250	0.04-0.10	100-300	0.03-0.08	150-300	0.03-0.08			30-60	0.04-0.08
150-300	0.04-0.15	100-300	0.04-0.10	100-300	0.04-0.10	150-300	0.02-0.08	30-60	0.04-0.08	30-60	0.04-0.08
						150-300	0.03-0.10				
						100-500	0.02-0.10				
100-300	0.02-0.05	100-250	0.01-0.04	100-250	0.01-0.04	100-300	0.02-0.05			30-60	0.01-0.04
100-300	0.02-0.05	100-250	0.02-0.05	100-250	0.02-0.05	100-300	0.02-0.05			30-60	0.02-0.06
100-300	0.02-0.05	100-250	0.02-0.05	100-250	0.02-0.05	100-300	0.02-0.05	30-60	0.02-0.06	30-60	0.02-0.06
100-300	0.02-0.05	100-250	0.01-0.04	100-250	0.01-0.04	100-300	0.02-0.05			30-60	0.01-0.04
100-300	0.02-0.05	100-250	0.02-0.05	100-250	0.02-0.05	100-300	0.02-0.05			30-60	0.02-0.06
100-300	0.02-0.05	100-250	0.02-0.05	100-250	0.02-0.05	100-300	0.02-0.05	30-60	0.02-0.06	30-60	0.02-0.06
100-300	0.02-0.05	100-250	0.01-0.04	100-250	0.01-0.04	100-300	0.02-0.05			30-60	0.01-0.04
100-300	0.02-0.05	100-250	0.02-0.05	100-250	0.02-0.05	100-300	0.02-0.05			30-60	0.02-0.06
100-300	0.02-0.05	100-250	0.02-0.05	100-250	0.02-0.05	100-300	0.02-0.05	30-60	0.02-0.06	30-60	0.02-0.06







CUT-LINE

Paramètres de coupe indicatifs

Empfohlene Schnittwerte

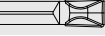
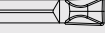
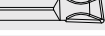
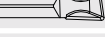
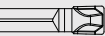
Standard machining data

CUT 22

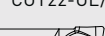
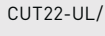
			P Acier Stahl Steel						M Inox Rostfreistahl Stainless steel	
			Acier de décolletage Automatenstahl Free-cutting steel		Acier faiblement allié Leicht legierter Stahl Low alloyed steel		Acier fortement allié Legierter Stahl High alloyed steel		Austénitique et martensitique Austenitisch und martensitisch Austenitic and martensitic	
			VC (m/min)	F (mm/U)	VC (m/min)	F (mm/U)	VC (m/min)	F (mm/U)	VC (m/min)	F (mm/U)
Avance standard Standard Vorschub Standard feed rate	CUT22-UN-002 CUT22-UR-802 	TiAlN	90-140	0.04-0.08	60-120	0.04-0.08	50-100	0.04-0.08	50-120	0.04-0.08
		Tmax	100-170	0.04-0.08	70-150	0.04-0.08	60-120	0.04-0.08	60-150	0.04-0.08
		Zmax	80-130*	0.04-0.10	50-110*	0.04-0.10	50-90*	0.04-0.08	50-120*	0.04-0.10
		HTA	70-120	0.04-0.06	60-100	0.04-0.06	50-90	0.04-0.06	50-100	0.04-0.06
		AS								
	CUT22-PN-002 	TiAlN	90-140	0.04-0.10	60-120	0.04-0.08	50-100	0.04-0.08		
	Tmax	100-170	0.04-0.10	70-150	0.04-0.10	60-120	0.04-0.10			
	CUT22-PNW-002 	N								
	CUT22-PR-002 	TiAlN	90-140	0.04-0.08	60-120	0.04-0.08	50-100	0.04-0.08	50-120	0.04-0.08
	Tmax	100-170	0.04-0.08	70-150	0.04-0.08	60-120	0.04-0.08	60-150	0.04-0.08	
CUT22-PRW-002 	N									
CUT22-TN-002 	TiAlN	90-140	0.08-0.18	60-120	0.08-0.18	50-100	0.08-0.15	50-120	0.08-0.20	
Tmax	100-170	0.08-0.18	70-150	0.08-0.18	60-120	0.08-0.15	60-150	0.08-0.20		
Zmax	80-130*	0.08-0.18	50-110*	0.08-0.18	50-90*	0.08-0.15				
CUT22-GN-002 *** 	TiAlN	90-140	0.03-0.12	60-120	0.03-0.12	50-100	0.03-0.10	50-120	0.03-0.08	
Tmax	100-170	0.03-0.12	70-150	0.03-0.12	60-120	0.03-0.10	70-120	0.03-0.08		
AS										
Avance modérée Niedriger Vorschub Low feed rate	CUT22-UN-000F 	TiAlN	80-130	0.02-0.05	50-110	0.02-0.05	50-90	0.02-0.05	50-80	0.02-0.05
		HTA	60-100	0.01-0.04	50-90	0.01-0.04	50-80	0.02-0.05	50-80	0.02-0.05
		AS								
	CUT22-UL/R-800F 	TiAlN	80-130	0.02-0.05	50-110	0.02-0.05	50-90	0.02-0.05	50-80	0.02-0.05
		HTA	60-100	0.01-0.04	50-90	0.01-0.04	50-80	0.02-0.05	50-80	0.02-0.05
		AS								
	CUT22-UL/R-802F 	TiAlN	80-130	0.02-0.05	50-110	0.02-0.05	50-90	0.02-0.05	50-80	0.02-0.05
		HTA	60-100	0.01-0.04	50-90	0.01-0.04	50-80	0.02-0.05	50-80	0.02-0.05
		AS								
	CUT22-UL/R-1500F 	TiAlN	80-130	0.02-0.05	50-110	0.02-0.05	50-90	0.02-0.05	50-80	0.02-0.05
		HTA	60-100	0.01-0.04	50-90	0.01-0.04	50-80	0.02-0.05	50-80	0.02-0.05
		AS								

* premier choix en cas de coupe interrompue

** arête de coupe vive

*** géométrie fonçage-tournage (évent. tronçonnage)

* beste Basis für unterbrochene Schnitte

** scharfe Schneidkante

*** Geometrie zum einstechen und drehen (event. abstechen)

* first choice for interrupted cut

** sharp cutting edge

*** geometry for grooving and turning (event. parting off)

N Allages d'aluminium et non ferreux Aluminium- und Nichteisenlegierungen Aluminium and non-ferrous alloys								S Titane Titan Titanium			
Aluminium		Alu silicium max. 5% Aluminiumsilicium max. 5% Aluminium silicon max. 5%		Cuivre Kupfer Copper		Laiton & bronze Messing & Bronze Brass & bronze		Gr. 1 - 3		Gr. 4 - 5	
VC (m/min)	F (mm/U)	VC (m/min)	F (mm/U)	VC (m/min)	F (mm/U)	VC (m/min)	F (mm/U)	VC (m/min)	F (mm/U)	VC (m/min)	F (mm/U)
100-250	0.03-0.10	100-250	0.03-0.10	100-300	0.03-0.10	100-300	0.03-0.10			30-60	0.04-0.08
100-300	0.04-0.10	100-250	0.04-0.10	100-300	0.03-0.08	150-300	0.03-0.08			30-60	0.04-0.08
150-300	0.04-0.15	100-300	0.04-0.10	100-300	0.04-0.10	150-300	0.02-0.08	30-60	0.04-0.08	30-60	0.04-0.08
						150-300	0.03-0.10				
						100-500	0.02-0.10				
						150-300	0.03-0.10				
						100-500	0.02-0.10				
						150-300	0.05-0.2				
100-300	0.03-0.12	100-200	0.03-0.10	100-200	0.03-0.10	100-300	0.03-0.12			30-60	0.04-0.08
						100-300	0.03-0.12				
100-300	0.03-0.12	100-200	0.03-0.10	100-200	0.03-0.10	100-300	0.03-0.12	30-60	0.04-0.08	30-60	0.04-0.08
100-300	0.02-0.05	100-250	0.01-0.04	100-250	0.01-0.04	100-300	0.02-0.05			30-60	0.01-0.04
100-300	0.02-0.05	100-250	0.02-0.05	100-250	0.02-0.05	100-300	0.02-0.05			30-60	0.02-0.06
100-300	0.02-0.05	100-250	0.02-0.05	100-250	0.02-0.05	100-300	0.02-0.05	30-60	0.02-0.06	30-60	0.02-0.06
100-300	0.02-0.05	100-250	0.01-0.04	100-250	0.01-0.04	100-300	0.02-0.05			30-60	0.01-0.04
100-300	0.02-0.05	100-250	0.02-0.05	100-250	0.02-0.05	100-300	0.02-0.05			30-60	0.02-0.06
100-300	0.02-0.05	100-250	0.02-0.05	100-250	0.02-0.05	100-300	0.02-0.05	30-60	0.02-0.06	30-60	0.02-0.06
100-300	0.02-0.05	100-250	0.01-0.04	100-250	0.01-0.04	100-300	0.02-0.05			30-60	0.01-0.04
100-300	0.02-0.05	100-250	0.02-0.05	100-250	0.02-0.05	100-300	0.02-0.05			30-60	0.02-0.06
100-300	0.02-0.05	100-250	0.02-0.05	100-250	0.02-0.05	100-300	0.02-0.05	30-60	0.02-0.06	30-60	0.02-0.06
100-300	0.02-0.05	100-250	0.01-0.04	100-250	0.01-0.04	100-300	0.02-0.05			30-60	0.01-0.04
100-300	0.02-0.05	100-250	0.02-0.05	100-250	0.02-0.05	100-300	0.02-0.05			30-60	0.02-0.06
100-300	0.02-0.05	100-250	0.02-0.05	100-250	0.02-0.05	100-300	0.02-0.05	30-60	0.02-0.06	30-60	0.02-0.06







CUT-LINE

Paramètres de coupe indicatifs

Empfohlene Schnittwerte

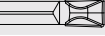
Standard machining data

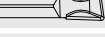
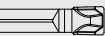
CUT 31

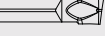
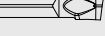
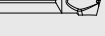
		P Acier Stahl Steel						M Inox Rostfreistahl Stainless steel		
		Acier de décolletage Automatenstahl Free-cutting steel		Acier faiblement allié Leicht legierter Stahl Low alloyed steel		Acier fortement allié Legierter Stahl High alloyed steel		Austénitique et martensitique Austenitisch und martensitisch Austenitic and martensitic		
		VC (m/min)	F (mm/U)	VC (m/min)	F (mm/U)	VC (m/min)	F (mm/U)	VC (m/min)	F (mm/U)	
Avance standard Standard Vorschub Standard feed rate	CUT31-UN-002 	TiAlN	90-140	0.04-0.08	60-120	0.04-0.08	50-100	0.04-0.08	50-120	0.04-0.10
		Tmax	100-170	0.04-0.08	70-150	0.04-0.08	60-120	0.04-0.08	60-150	0.04-0.10
		Zmax	80-130*	0.04-0.10	50-110*	0.04-0.10	50-90*	0.04-0.08	50-120*	0.04-0.10
		HTA	70-120	0.04-0.06	60-100	0.04-0.06	50-90	0.04-0.06	50-100	0.04-0.06
		AS								
	CUT31-PN-002 	TiAlN	90-140	0.04-0.10	60-120	0.04-0.08	50-100	0.04-0.08		
	Tmax	100-170	0.04-0.10	70-150	0.04-0.10	60-120	0.04-0.10			
	CUT31-PNW-002 	N								
	CUT31-PR-802 	TiAlN	90-140	0.04-0.08	60-120	0.04-0.08	50-100	0.04-0.08	50-120	0.04-0.08
	Tmax	100-170	0.04-0.08	70-150	0.04-0.08	60-120	0.04-0.08	60-150	0.04-0.08	
CUT31-PRW-802 	N									
CUT31-TN-002 	TiAlN	90-140	0.08-0.20	60-120	0.08-0.20	50-100	0.08-0.15	50-120	0.08-0.20	
Tmax	100-170	0.08-0.20	70-150	0.08-0.20	60-120	0.08-0.15	60-150	0.08-0.20		
Zmax	80-130*	0.08-0.20	50-110*	0.08-0.20	50-90*	0.08-0.15				
CUT31-GN-002 *** 	TiAlN	90-140	0.04-0.15	60-120	0.04-0.15	50-100	0.04-0.10	50-120	0.04-0.10	
Tmax	100-170	0.04-0.15	70-150	0.04-0.15	60-120	0.04-0.10	70-120	0.04-0.10		
AS										
Avance modérée Niedriger Vorschub Low feed rate	CUT31-UN-000F 	TiAlN	80-130	0.02-0.05	50-110	0.02-0.05	50-90	0.02-0.05	50-80	0.02-0.05
		HTA	60-100	0.01-0.04	50-90	0.01-0.04	50-80	0.02-0.05	50-80	0.02-0.05
		AS								
	CUT31-UL/R-800F 	TiAlN	80-130	0.02-0.05	50-110	0.02-0.05	50-90	0.02-0.05	50-80	0.02-0.05
		HTA	60-100	0.01-0.04	50-90	0.01-0.04	50-80	0.02-0.05	50-80	0.02-0.05
		AS								
	CUT31-UL/R-802F 	TiAlN	80-130	0.02-0.05	50-110	0.02-0.05	50-90	0.02-0.05	50-80	0.02-0.05
		HTA	60-100	0.01-0.04	50-90	0.01-0.04	50-80	0.02-0.05	50-80	0.02-0.05
		AS								
	CUT31-UL/R-1500F 	TiAlN	80-130	0.02-0.05	50-110	0.02-0.05	50-90	0.02-0.05	50-80	0.02-0.05
		HTA	60-100	0.01-0.04	50-90	0.01-0.04	50-80	0.02-0.05	50-80	0.02-0.05
		AS								

* premier choix en cas de coupe interrompue

** arête de coupe vive

*** géométrie fonçage-tournage (évent. tronçonnage)

* beste Basis für unterbrochene Schnitte

** scharfe Schneidkante

*** Geometrie zum einstechen und drehen (event. abstechen)

* first choice for interrupted cut

** sharp cutting edge

*** geometry for grooving and turning (event. parting off)

N Allages d'aluminium et non ferreux Aluminium- und Nichteisenlegierungen Aluminium and non-ferrous alloys								S Titane Titan Titanium			
Aluminium		Alu silicium max. 5% Aluminiumsilicium max. 5% Aluminium silicium max. 5%		Cuivre Kupfer Copper		Laiton & bronze Messing & Bronze Brass & Bronze		Gr. 1 - 3		Gr. 4 - 5	
VC (m/min)	F (mm/U)	VC (m/min)	F (mm/U)	VC (m/min)	F (mm/U)	VC (m/min)	F (mm/U)	VC (m/min)	F (mm/U)	VC (m/min)	F (mm/U)
100-250	0.03-0.10	100-250	0.03-0.10	100-300	0.03-0.10	100-300	0.03-0.10			30-60	0.04-0.08
100-300	0.04-0.10	100-250	0.04-0.10	100-300	0.03-0.08	150-300	0.03-0.08			30-60	0.04-0.08
150-300	0.04-0.15	100-300	0.04-0.10	100-300	0.04-0.10	150-300	0.02-0.08	30-60	0.04-0.08	30-60	0.04-0.08
						150-300	0.03-0.10				
						100-500	0.02-0.15				
						150-300	0.03-0.10				
						100-500	0.02-0.15				
						150-300	0.05-0.20				
100-300	0.04-0.15	100-200	0.04-0.10	100-200	0.04-0.10	100-300	0.04-0.15			30-60	0.04-0.08
						100-300	0.04-0.15				
100-300	0.04-0.15	100-200	0.04-0.10	100-200	0.04-0.10	100-300	0.04-0.15	30-60	0.04-0.08	30-60	0.04-0.08
100-300	0.02-0.05	100-250	0.01-0.04	100-250	0.01-0.04	100-300	0.02-0.05			30-60	0.01-0.04
100-300	0.02-0.05	100-250	0.02-0.05	100-250	0.02-0.05	100-300	0.02-0.05			30-60	0.02-0.06
100-300	0.02-0.05	100-250	0.02-0.05	100-250	0.02-0.05	100-300	0.02-0.05	30-60	0.02-0.06	30-60	0.02-0.06
100-300	0.02-0.05	100-250	0.01-0.04	100-250	0.01-0.04	100-300	0.02-0.05			30-60	0.01-0.04
100-300	0.02-0.05	100-250	0.02-0.05	100-250	0.02-0.05	100-300	0.02-0.05			30-60	0.02-0.06
100-300	0.02-0.05	100-250	0.02-0.05	100-250	0.02-0.05	100-300	0.02-0.05	30-60	0.02-0.06	30-60	0.02-0.06
100-300	0.02-0.05	100-250	0.01-0.04	100-250	0.01-0.04	100-300	0.02-0.05			30-60	0.01-0.04
100-300	0.02-0.05	100-250	0.02-0.05	100-250	0.02-0.05	100-300	0.02-0.05			30-60	0.02-0.06
100-300	0.02-0.05	100-250	0.02-0.05	100-250	0.02-0.05	100-300	0.02-0.05	30-60	0.02-0.06	30-60	0.02-0.06
100-300	0.02-0.05	100-250	0.01-0.04	100-250	0.01-0.04	100-300	0.02-0.05			30-60	0.01-0.04
100-300	0.02-0.05	100-250	0.02-0.05	100-250	0.02-0.05	100-300	0.02-0.05			30-60	0.02-0.06
100-300	0.02-0.05	100-250	0.02-0.05	100-250	0.02-0.05	100-300	0.02-0.05	30-60	0.02-0.06	30-60	0.02-0.06



CUT-LINE



Porte-outils
Halter
Holders

Ø max 34 mm

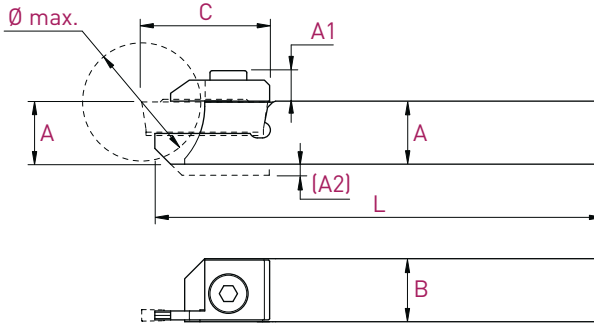
H Series



Plaquettes WSP Inserts	A x B x L	Ø max.	A1	C	Art. N°	Art. N°
W 1.6 mm Type CUT16	8 x 10 x 115 (A2=2)	16	6.2	19.5	CUT16-H0810L	CUT16-H0810R
	10 x 10 x 115	16	6.2	19.5	CUT16-H1010L	CUT16-H1010R
	12 x 12 x 130	16	6.2	19.5	CUT16-H1212L	CUT16-H1212R
	12 x 12 x 90	16	6.2	19.5	CUT16-H1212L-90	CUT16-H1212R-90
	12.7 x 12.7 x 130	16	6.2	19.5	CUT16-H127127L	CUT16-H127127R
	16 x 16 x 130	16	6.2	19.5	CUT16-H1616L	CUT16-H1616R
	20 x 20 x 120	16	6.2	19.5	CUT16-H2020L	CUT16-H2020R
W 2.2 mm Type CUT22	10 x 12 x 115	20	6.4	24	CUT22-H1012L	CUT22-H1012R
	12 x 12 x 130	20	6.4	24	CUT22-H1212L	CUT22-H1212R
	12 x 12 x 90	20	6.4	24	CUT22-H1212L-90	CUT22-H1212R-90
	12.7 x 12.7 x 130	20	6.4	24	CUT22-H127127L	CUT22-H127127R
	16 x 16 x 130	20	6.4	24	CUT22-H1616L	CUT22-H1616R
	20 x 20 x 120	20	6.4	24	CUT22-H2020L	CUT22-H2020R
W 3.1 mm Type CUT31	16 x 16 x 130	34	7.8	35	CUT31-H1616L	CUT31-H1616R
	20 x 20 x 120	34	7.8	35	CUT31-H2020L	CUT31-H2020R
	25 x 25 x 140	34	7.8	35	CUT31-H2525L	CUT31-H2525R

Pièces de rechange Ersatzteile Spare parts	L 	 R		Serrage Anzug Torque
	Art. N°	Art. N°	Art. N°	
CUT 16	CUT16L-SET	CUT16R-SET	V-M4X10-BN7	3.5 Nm
CUT 22	CUT22L-SET	CUT22R-SET	V-M4X10-BN7	3.5 Nm
CUT 31	CUT31L-SET	CUT31R-SET	V-M5X10-BN7	4.5 Nm

Porte-outils

Halter

Holders

Ø max 42 mm

HX Series

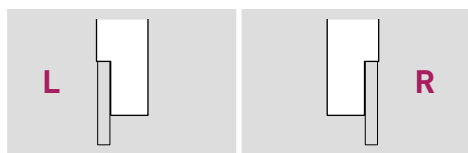
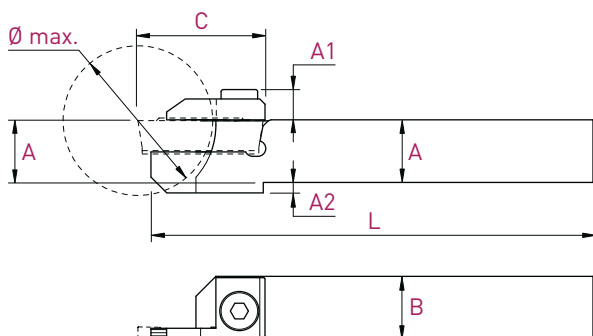

Plaquettes WSP Inserts	A x B x L	Ø max.	A1	C	A2	Art. N°	Art. N°
W 1.6 mm Type CUT16	10 x 12 x 115	20	6.2	21	2	CUT16-H1012LX	CUT16-H1012RX
	12 x 12 x 130	20	6.2	21	-	CUT16-H1212LX	CUT16-H1212RX
	12 x 12 x 90	20	6.2	21	-	CUT16-H1212LX-90	CUT16-H1212RX-90
	12.7 x 12.7 x 130	20	6.2	21	-	CUT16-H127127LX	CUT16-H127127RX
	16 x 16 x 130	20	6.2	21	-	CUT16-H1616LX	CUT16-H1616RX
	20 x 20 x 120	20	6.2	21	-	CUT16-H2020LX	CUT16-H2020RX
W 2.2 mm Type CUT22	10 x 12 x 115	26	6.4	25	4	CUT22-H1012LX	CUT22-H1012RX
	12 x 12 x 130	26	6.4	25	2	CUT22-H1212LX	CUT22-H1212RX
	12 x 12 x 90	26	6.4	25	2	CUT22-H1212LX-90	CUT22-H1212RX-90
	12.7 x 12.7 x 130	26	6.4	25	-	CUT22-H127127LX	CUT22-H127127RX
	16 x 16 x 130	26	6.4	25	-	CUT22-H1616LX	CUT22-H1616RX
	20 x 20 x 120	26	6.4	25	-	CUT22-H2020LX	CUT22-H2020RX
W 3.1 mm Type CUT31	16 x 16 x 120	42	7.8	37	4	CUT31-H1616LX	CUT31-H1616RX
	20 x 20 x 120	42	7.8	37	-	CUT31-H2020LX	CUT31-H2020RX
	25 x 25 x 140	42	7.8	37	-	CUT31-H2525LX	CUT31-H2525RX

Pièces de rechange Ersatzteile Spare parts	L	R		Serrage Anzug Torque
	Art. N°	Art. N°	Art. N°	
CUT 16	CUT16LX-SET	CUT16RX-SET	V-M4X10-BN7	3.5 Nm
CUT 22	CUT22LX-SET	CUT22RX-SET	V-M4X10-BN7	3.5 Nm
CUT 31	CUT31LX-SET	CUT31RX-SET	V-M5X10-BN7	4.5 Nm

CUT-LINE

Porte-outils

Halter

Holder

Ø max 65 mm

HZ Series

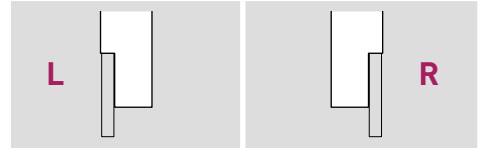
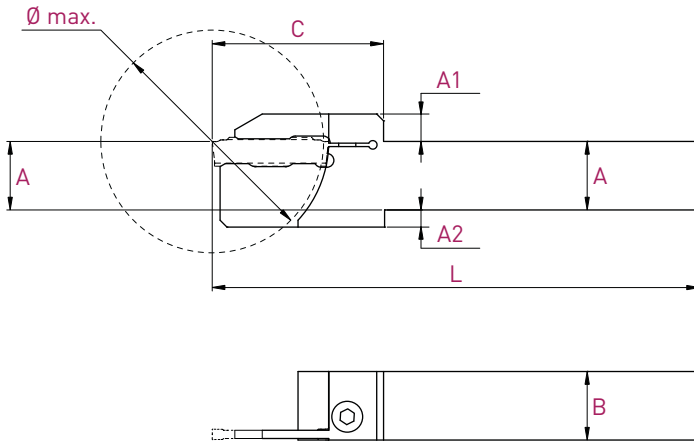

Plaquettes WSP Inserts	A x B x L	Ø max.	A1	C	A2	Art. N°	Art. N°
W 2.2 mm	16 x 16 x 130	32	7	30	-	CUT22-H1616LZ-D32	CUT22-H1616RZ-D32
	20 x 20 x 130	32	7	30	-	CUT22-H2020LZ-D32	CUT22-H2020RZ-D32
Type CUT22	16 x 16 x 130	42	7	35	4	CUT22-H1616LZ-D42	CUT22-H1616RZ-D42
	20 x 20 x 130	42	7	35	-	CUT22-H2020LZ-D42	CUT22-H2020RZ-D42
W 3.1 mm	20 x 20 x 140	52	8	44	5	CUT31-H2020LZ-D52	CUT31-H2020RZ-D52
	25 x 25 x 140	52	8	44	-	CUT31-H2525LZ-D52	CUT31-H2525RZ-D52
Type CUT31	20 x 20 x 140	65	8	50	5	CUT31-H2020LZ-D65	CUT31-H2020RZ-D65
	25 x 25 x 140	65	8	50	-	CUT31-H2525LZ-D65	CUT31-H2525RZ-D65

Pièces de rechange Ersatzteile Spare parts		Serrage Anzug Torque
	Art. N°	
CUT 22	V-M4X10-BN7	3.5 Nm
CUT 31	V-M5X10-BN7	4.5 Nm

Porte-outils avec arrosage intégré
 Halter mit integrierter Kühlmittelzufuhr
 Holders with integrated coolant supply

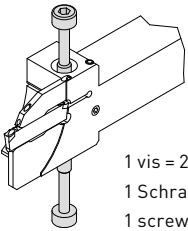
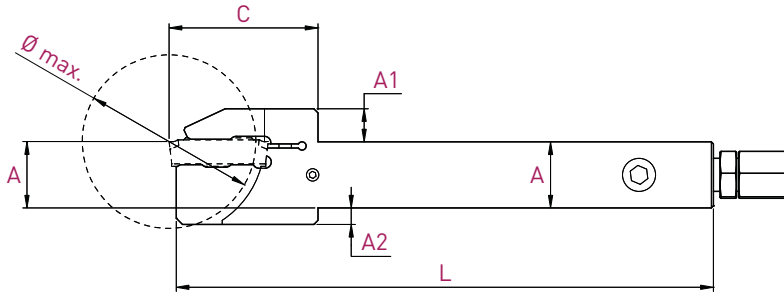

HZ-JET Series

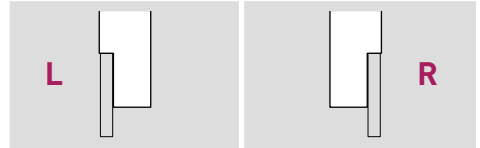

1 vis = 2 possibilités de serrage
 1 Schraube = 2 Spannmöglichkeiten
 1 screw = 2 clamp possibilities



Plaquettes WSP Inserts	A x B x L	Ø max.	A1	C	A2	Art. N°	Art. N°
Type CUT22	16 x 16 x 130	42	8	36	4	CUT22-H1616LZ-JET42	CUT22-H1616RZ-JET42
	20 x 20 x 130	42	8	36	-	CUT22-H2020LZ-JET42	CUT22-H2020RZ-JET42
Type CUT31	16 x 16 x 140	65	9	49	9	CUT31-H1616LZ-JET65	CUT31-H1616RZ-JET65
	20 x 20 x 140	65	9	51	5	CUT31-H2020LZ-JET65	CUT31-H2020RZ-JET65
	25 x 25 x 140	65	9	51	-	CUT31-H2525LZ-JET65	CUT31-H2525RZ-JET65

Pièces de rechange Ersatzteile Spare parts		Serrage Anzug Torque		
	Art. N°		Art. N°	Art. N°
CUT 22	V-M4X22-CUT	3.5 Nm	J-M8X1-D6	JB-M8X1
CUT 31	V-M5X25-CUT	4.5 Nm	J-M8X1-D6	JB-M8X1

CUT-LINE

Plaquettes de tronçonnage
 Abstechwendeplatten
 Cut off inserts

UN Series

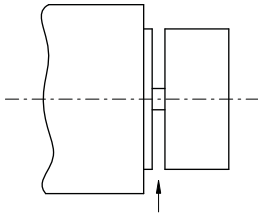
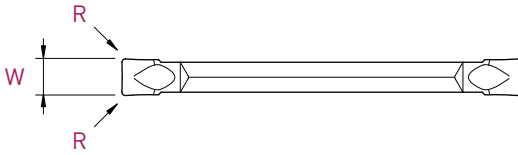
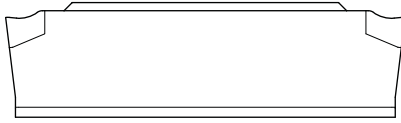

Type	W ± 0.05	R	Art. N°	TiAlN	Tmax	Zmax	HTA	AS
CUT16	1.6	0.02	CUT16-UN-000F	■			■	■
	1.6	0.10	CUT16-UN-001	■	■	■	■	■
CUT22	2.2	0.02	CUT22-UN-000F	■			■	■
	2.2	0.20	CUT22-UN-002	■	■	■	■	■
CUT31	3.1	0.02	CUT31-UN-000F	■			■	■
	3.1	0.20	CUT31-UN-002	■	■	■	■	■

Plaquettes de tronçonnage

Abstechwendeplatten

Cut off inserts

UL-UR Series

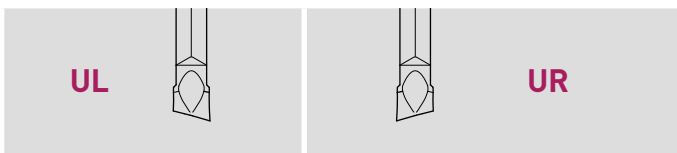
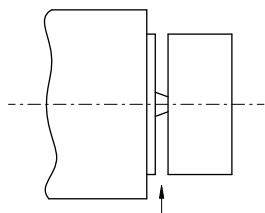
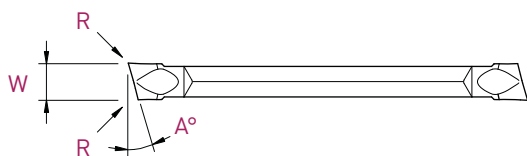
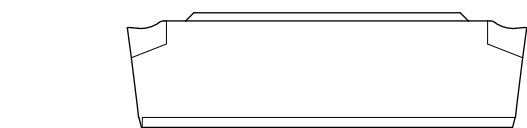

Type	W ±0.05	A	R	UL			UR						
				Art. N°	TiAlN	HTA	AS	Art. N°	TiAlN	Tmax	Zmax	HTA	AS
CUT16	1.6	8°	0.02	CUT16-UL-800F	■	■	■	CUT16-UR-800F	■			■	■
	1.6	15°	0.02	CUT16-UL-1500F	■	■	■	CUT16-UR-1500F	■			■	■
CUT22	2.2	8°	0.02	CUT22-UL-800F	■	■	■	CUT22-UR-800F	■			■	■
	2.2	8°	0.20	-				CUT22-UR-802		■	■		NEW
	2.2	8°	0.20	CUT22-UL-802F	■	■	■	CUT22-UR-802F	■			■	■
	2.2	15°	0.02	CUT22-UL-1500F	■	■	■	CUT22-UR-1500F	■			■	■
CUT31	3.1	8°	0.02	CUT31-UL-800F	■	■	■	CUT31-UR-800F	■			■	■
	3.1	8°	0.20	CUT31-UL-802F	■	■	■	CUT31-UR-802F	■			■	■
	3.1	15°	0.02	CUT31-UL-1500F	■	■	■	CUT31-UR-1500F	■			■	■

CUT-LINE

Plaquettes de tronçonnage

Abstechwendeplatten

Cut off inserts

PN Series

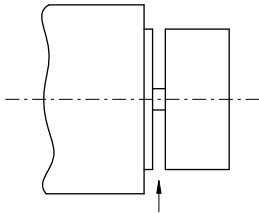
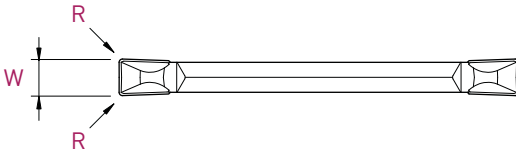
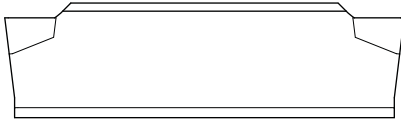

Type	W ± 0.05	R	Art. N°	TiAlN	Tmax
CUT22	2.2	0.20	CUT22-PN-002	■	■
CUT31	3.1	0.20	CUT31-PN-002	■	■

Plaquettes de tronçonnage

Abstechwendeplatten

Cut off inserts

PR Series

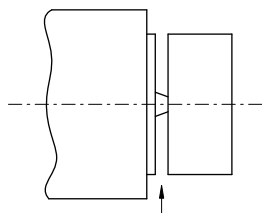
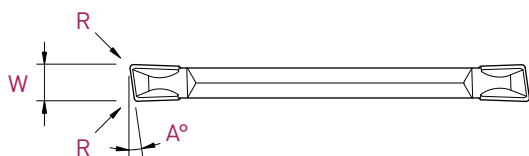
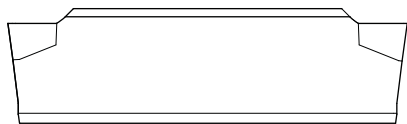

Type	W ± 0.05	A	R	Art. N°	TiAlN	Tmax
CUT16	1.6	8°	0.10	CUT16-PR-801	■	■
CUT22	2.2	8°	0.20	CUT22-PR-802	■	■
CUT31	3.1	8°	0.20	CUT31-PR-802	■	■

CUT-LINE

Plaquettes de tronçonnage

Abstechwendeplatten

Cut off inserts

PNW Series

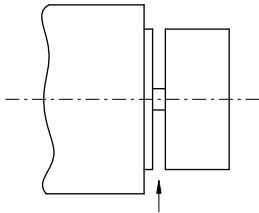
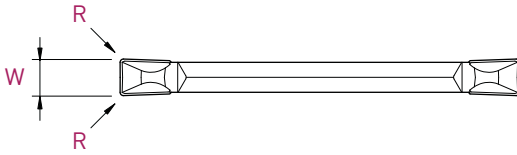
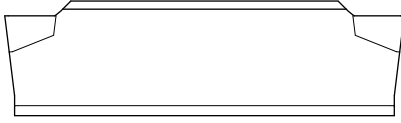

NEW

PNW



Type	W ± 0.05	R	Art. N°	Z
CUT22	2.2	0.20	CUT22-PNW-002	■
CUT31	3.1	0.20	CUT31-PNW-002	■

Plaquettes de tronçonnage

Abstechwendeplatten

Cut off inserts

PRW Series

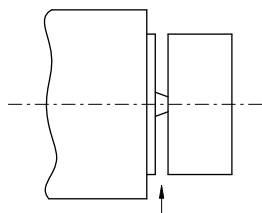
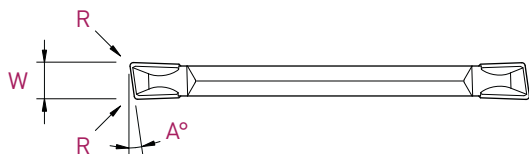
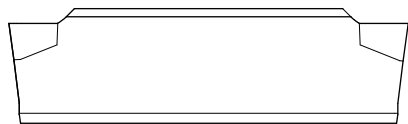

NEW

PRW



Type	W ± 0.05	A	R	Art. N°	z
CUT16	1.6	8°	0.10	CUT16-PRW-801	■
CUT22	2.2	8°	0.20	CUT22-PRW-802	■
CUT31	3.1	8°	0.20	CUT31-PRW-802	■

CUT-LINE

Plaquettes de tronçonnage
 Abstechwendeplatten
 Cut off inserts

Negative geometry

TN Series

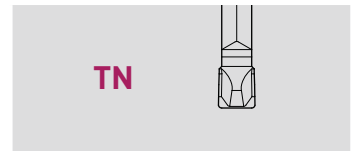
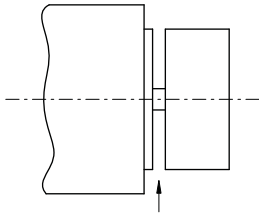
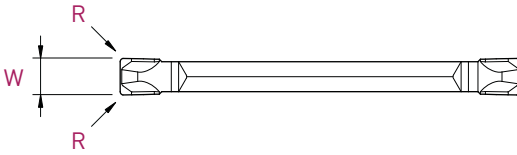
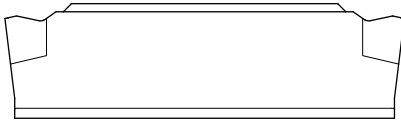

Type	W ± 0.05	R	Art. N°	TiAlN	Tmax	Zmax
CUT22	2.2	0.20	CUT22-TN-002	■	■	■
CUT31	3.1	0.20	CUT31-TN-002	■	■	■

Plaquettes de fonçage, tournage et tronçonnage
 WSP zum einstecken, drehen und abstechen
 Solid carbide inserts for grooving, turning and cut off

GN Series

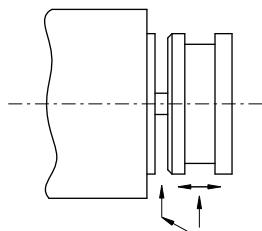
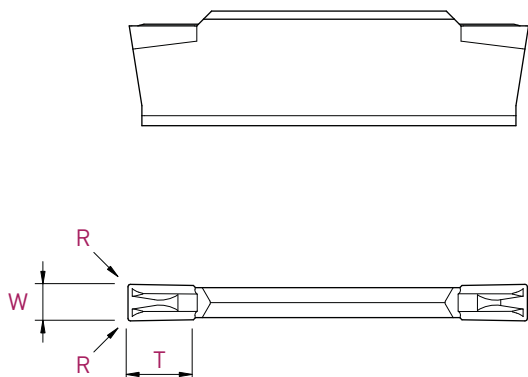

Type	W ±0.05	T	R	Art. N°	TiAlN	Tmax	AS
CUT22	2.2	3.5	0.15	CUT22-GN-002	■	■	■
CUT31	3.1	5.0	0.15	CUT31-GN-002	■	■	■

Conseils d'utilisation pour plaquettes type GN
 Anwendungsempfehlungen für GN-Wendeleplatten
 Application recommendations for GN inserts

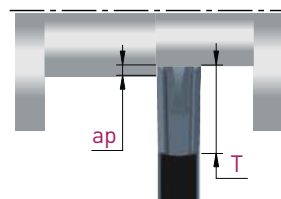
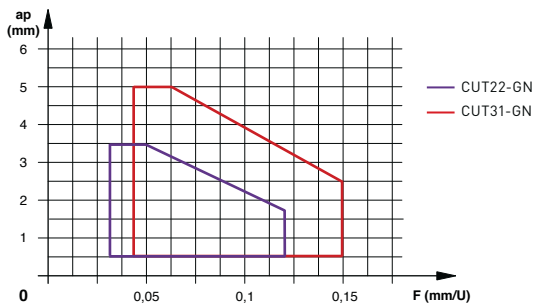

ap max = T dans matière à bonne usinabilité
 ap max = T in Werkstoffe mit gute Zerspanbarkeit
 ap max = T in material with good machinability

Nouveautés présentées dans ce catalogue
 Neuheiten dieses Kataloges
 New products introduced in this catalogue



New references		
Type Typ Type	Ref.	Page Seite Page
BH	BHS4-D16-110-F4	10.10
BB-C45	BB4R/L-0612-C45-E03	10.24
	BB4R/L-0714-C45-E03	
	BB4R/L-0918-C45-E05	
	BB4R/L-2575-C45-E05	
	BB4R/L-35105-C45-E05	
BF-C45	BF4R/L-0612-C45-E03	10.25
	BF4R/L-0714-C45-E03	
	BF4R/L-0918-C45-E05	
	BF4R/L-2575-C45-E05	
	BF4R/L-35105-C45-E05	

APPLITEC

BH

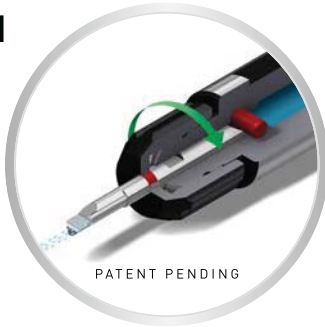

BHS

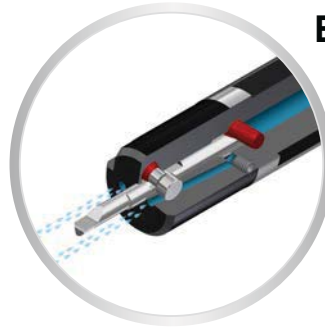

BHY

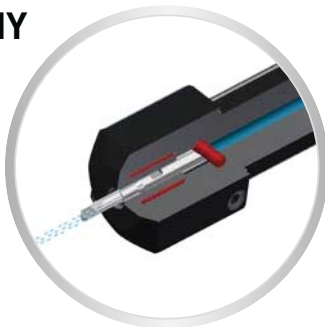

BHK

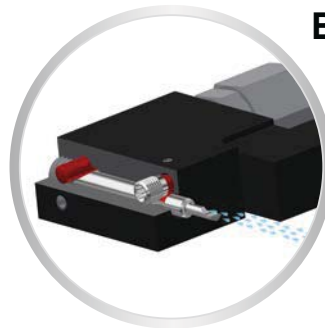

Système de désignation
Bezeichnungssystem
Designation system **Info** > **10.02**

Nuances & paramètres de coupe
Sorten & Schnittwerte
Grades & machining data > **10.08**

Porte-outils
Halter
Holders **BH / BHS / BHY / BHK** > **10.10**

Alésage
Ausbohren
Boring **BA / BAX**  > **10.18**

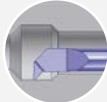

Alésage-copiage
Ausbohren-kopieren
Boring chambering **BCX**  > **10.22**

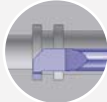
Copiage
Kopieren
Chambering **C45 / C45X**  > **10.24**

Gorge
Einstechen
Grooving **GX**  > **10.28**

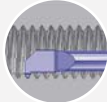
Fonçage-tournage
Einstechen und drehen
Grooving and turning **GTX**  > **10.30**

Filetage
Gewindedrehen
Threading **TP60° / TP55° / TM**  > **10.32**

Gorge frontale
Axiales Stechen
Axial grooving **FEG / FIG**   > **10.38**

Ébauches / Jauges d'alignement / Adaptations machines / Accessoires
Rohlinge / Richtplatten / Maschinenanpassungen / Zubehöre
Blanks / Adjusting tools / Machines adapters / Accessories > **10.40**

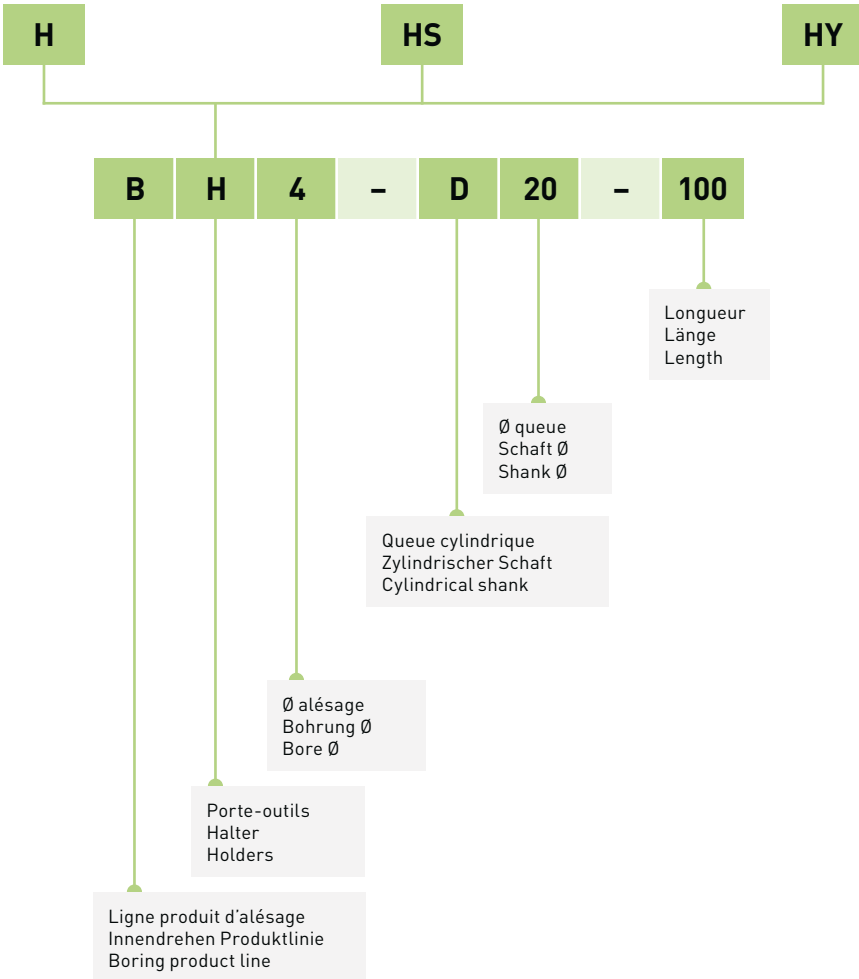

Système de désignation des porte-outils

Halter Bezeichnungssystem

Holders designation system

BHK

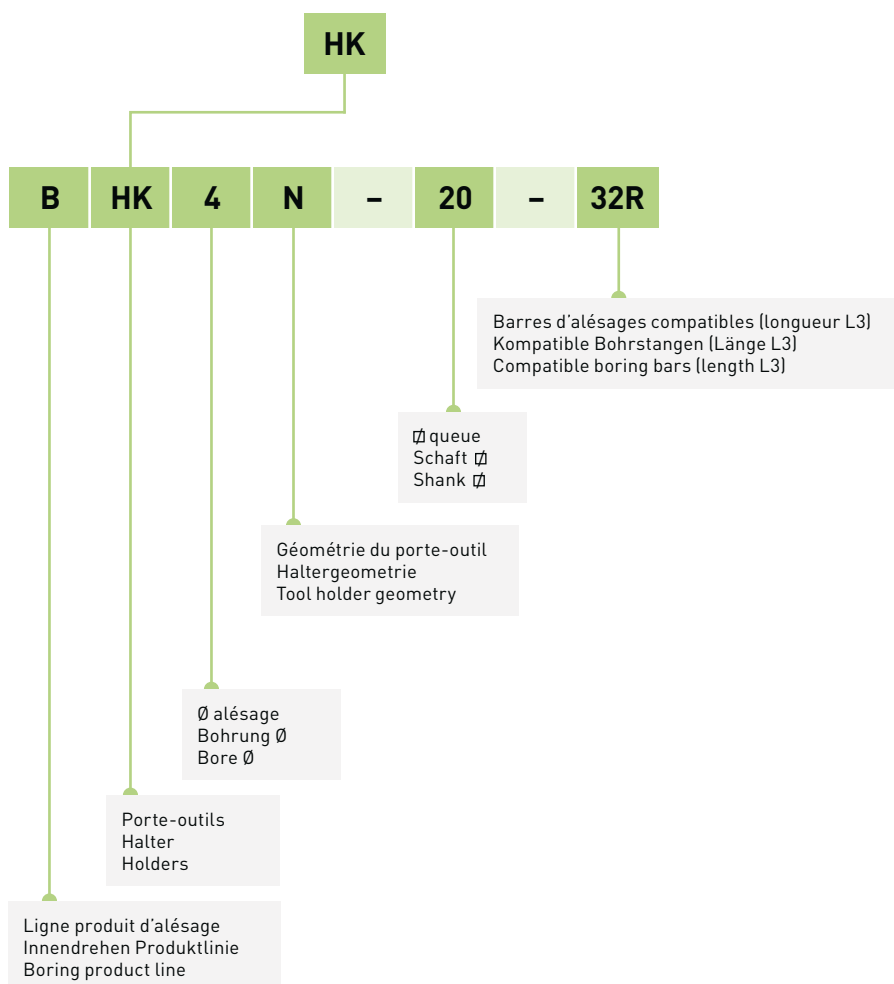
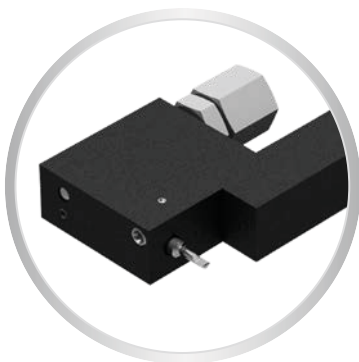

Système de désignation des barres d'alésage

Bohrstangen Bezeichnungssystem

Boring bars designation system

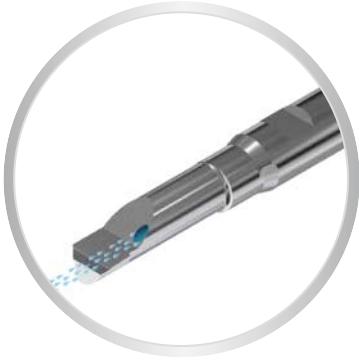

B

F

B B 4 R - 25 - 75 - BAX - R05 - ZN

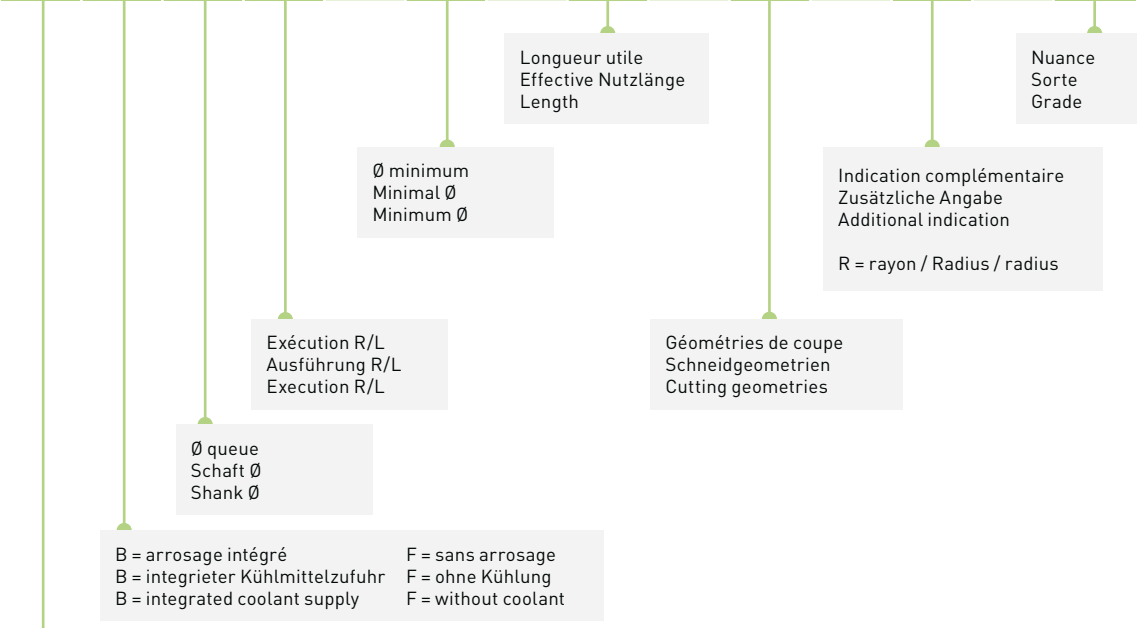

Ligne produit d'alésage
 Innendrehen Produktlinie
 Boring product line

Porte-outils avec écrou de serrage

Halter mit Spannmutter

Tool holders with clamping nut

BH

Arrosage par la barre d'alésage

Kühlung durch die Bohrstange

Cooling through the boring bar

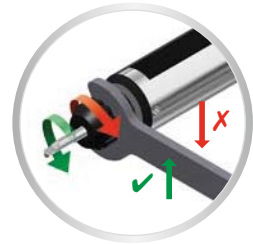
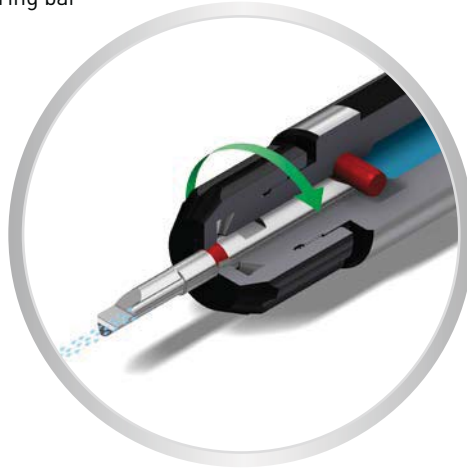

Porte-outils avec arrosage multiple

Halter mit mehrfaches Kühlungssystem

Tool holders with multiple coolant system

BHS

Système de serrage à vis transversale

Querverschraubungssystem

Clamping system with transverse screw

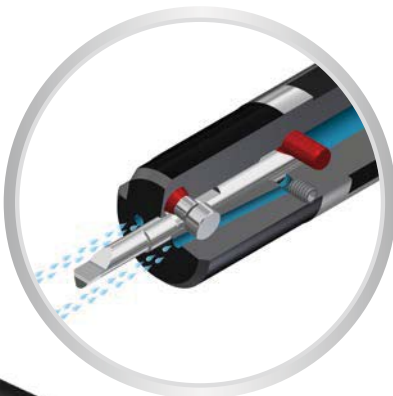

Arrosage sur l'arête de coupe

Kühlung auf der Schneidkante

Cooling on the cutting edge

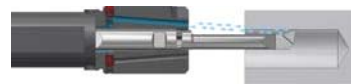

Arrosage favorisant l'évacuation des copeaux

Spanabfuhr fördernde Kühlung

Cooling for better chip outflow



Arrosage par le centre de l'outil

Zentrale Kühlmittelzufuhr

Cooling through the center of the tool



IN-LINE

Porte-outils à serrage hydraulique
Halter mit Hydro-Dehnspann-System
Tool holders with hydraulic clamping system

BHY

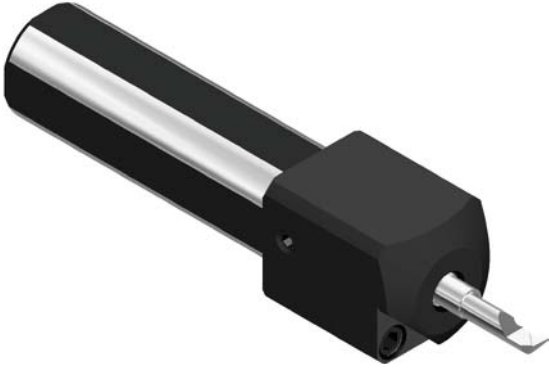

Excellente absorption des vibrations!
Ausgezeichnete Schwingungsdämpfung!
Excellent vibration absorbtion!

Arrosage par la barre d'alésage
Kühlung durch die Bohrstange
Cooling through the boring bar

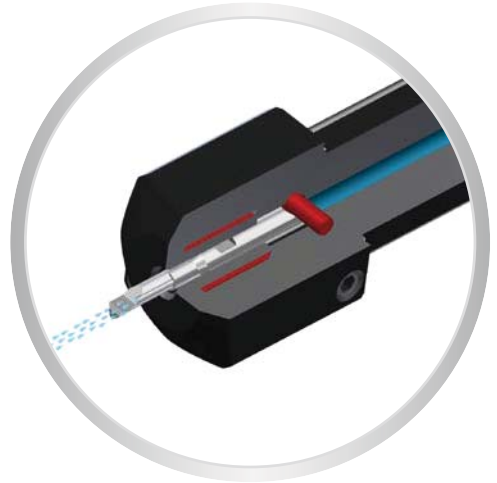

Porte-outils coudés
Gekröpfte Halter
Cranked tool holders

BHK

Système de serrage à vis transversale
Querverschraubungssystem
Clamping system with transverse screw

Arrosage par la barre d'alésage
Kühlung durch die Bohrstange
Cooling through the boring bar

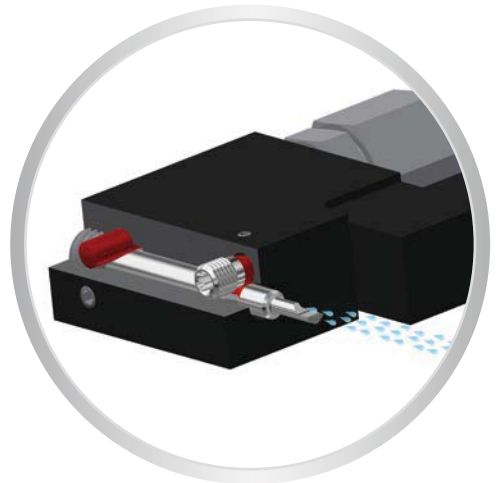
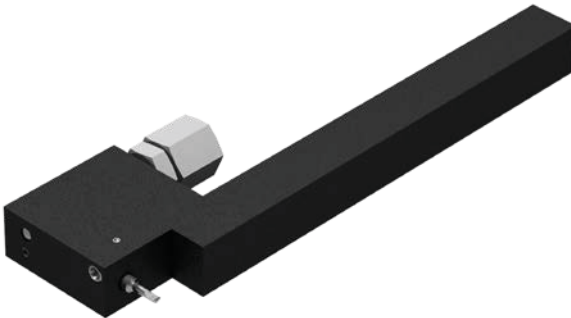

Accessoires de serrage

Spannzubehöre

Clamping accessories

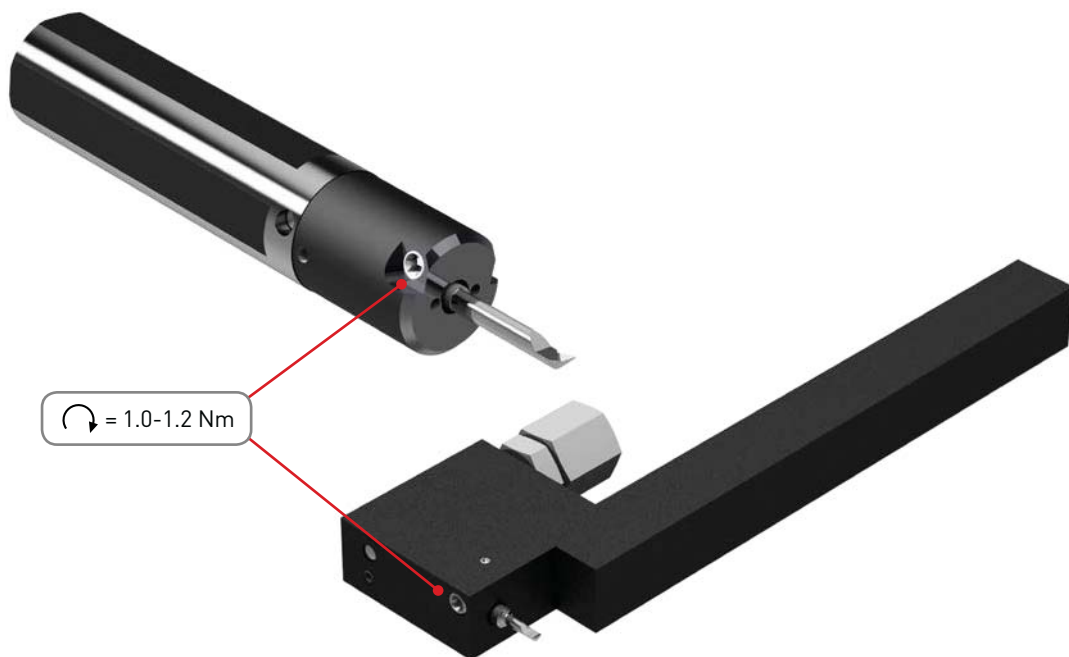

Nous recommandons le serrage des porte-outils types BHS et BHK avec ce type de tournevis dynamométrique.

Wir empfehlen für das Anziehen der Halter Typ BHS und BHK diese Art von Drehmomentschraubendreher.

For holders type BHS and BHK clamping, we recommend this kind of torque screwdriver.



Art. N°

SET-NM1.2-TX8

ZTAF

ZN + revêtement PVD
ZN + PVD Beschichtung
ZN + PVD coating

- nuance universelle pour l'usinage des aciers, aciers inoxydables, aciers alliés, alliage de titane
- bonne résistance à la température

- Universalsorte für die Bearbeitung von Stahl, rostfreiem Stahl, Stahllegierung, Titanlegierung
- gute Warmfestigkeit

- universal grade for steel, stainless steel, alloyed steel, titanium alloys
- good heat resistance

ZTAXF

ZN + revêtement PVD
ZN + PVD Beschichtung
ZN + PVD coating

- nuance très résistante à l'usure et à la température, recommandée pour l'usinage des matières suivantes: Inox 304, 316L, 317L, 904, Phynox
- aciers alliés contenant: Chrome Nickel, Vanadium, Molybdène, ...

- sehr verschleissfeste und temperaturbeständige Sorte. Für folgende Materialien empfohlen: Inox 304, 316L, 317L, 904, Phynox
- legierter Stahl enthaltend: Chrom-Nickel, Vanadium, Molybdän, ...

- very wear and high temperature resistant grade. Recommended for following material: Inox 304, 316L, 317L, 904, Phynox
- alloy steel containing: Chrome-nickel, Vanadium, Molybdenum, ...

ZN

non revêtu
unbeschichtet
uncoated

- nuance de base micro-grain tenace
- 1^{er} choix pour l'usinage des métaux non ferreux

- zähe Basis Feinkornsorte
- beste Wahl für die Bearbeitung von Nichteisenmetalle

- tough base micro-grain grade
- first choice for non-ferrous materials

Paramètres de coupe

Schnittwerte

Machining data

Matière Werkstoff Material	VC (m/min)	Ø barre d'alésage Bohrstange Ø boring bar Ø		
		Ø1.0 - Ø2.0 (mm/U)	Ø2.5 - Ø4.0 (mm/U)	Ø4.5 - Ø5.5 (mm/U)
Acier de décolletage Automatenstahl Free-cutting steel (P)	60-100	0.02-0.03	0.02-0.08	0.03-0.10
Acier faiblement allié Leicht legierter Stahl Low alloyed steel (P)	50-80	0.01-0.03	0.02-0.05	0.03-0.06
Acier fortement allié Legierter Stahl High alloyed steel (P)	40-60	0.01-0.02	0.02-0.04	0.02-0.06
Acier inoxydable Rostfreistahl Stainless steel (M)	40-90	0.01-0.03	0.02-0.05	0.03-0.08
Aluminium (N)	60-150	0.01-0.03	0.02-0.06	0.03-0.10
Cuivre, laiton, bronze Kupfer, Messing, Bronze Copper, brass, bronze (N)	60-150	0.01-0.03	0.02-0.05	0.03-0.08
Titane Titan Titanium (S)	30-70	0.01-0.03	0.02-0.05	0.03-0.10

IN-LINE

Porte-outils avec écrou de serrage

Halter mit Spannmutter

Tool holders with clamping nut

BH4...



> page 10.05

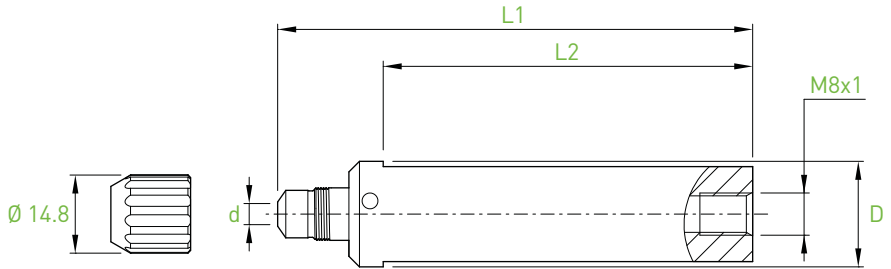
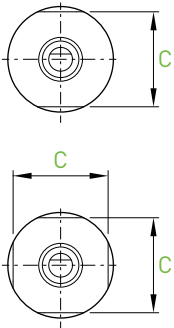

d	Bars	D	L1	L2	C	2 flats	4 flats	Art. N°
4	BB4... BF4...	10	75	55	8.8	■		BH4-D10-75
		12	75	55	11.2	■		BH4-D12-75
		12.7	75	55	11.2	■		BH4-D12.7-75
		15.87	75	55	14	■		BH4-D15.87-75
		16	75	55	14	■		BH4-D16-75
		16	75	55	14		■	BH4-D16-75-F4
		19.05	90	70	17	■		BH4-D19.05-90
		20	90	70	18	■		BH4-D20-90
		20	90	70	18		■	BH4-D20-90-F4
		20	160	140	18		■	BH4-D20-160-F4
		22	90	70	20	■		BH4-D22-90
		22	90	70	20		■	BH4-D22-90-F4
		22	130	110	20		■	BH4-D22-130-F4
		25	100	80	23	■		BH4-D25-100
		25	100	80	23		■	BH4-D25-100-F4
		25	170	150	23		■	BH4-D25-170-F4
25.4	100	80	23.4	■		BH4-D25.4-100		
28	100	80	26	■		BH4-D28-100		

Pièces de rechange
Ersatzteile
Spare parts



Art. N°

BH4...

BH4-M10

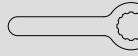

Art. N°

C-BH4-M10

Option

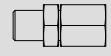

Art. N°

BH4...

J-M8x1-D6

Porte-outils avec écrou de serrage

Halter mit Spannmutter

Tool holders with clamping nut

BH6...



> page 10.05

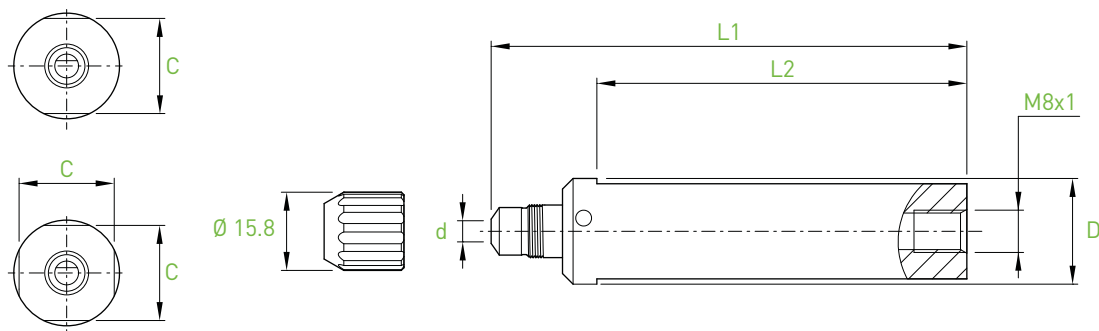

d	Bars	D	L1	L2	C	2 flats	4 flats	Art. N°
6	BH6... BF6...	12	75	55	11.2	■		BH6-D12-75
		12.7	75	55	11.2	■		BH6-D12.7-75
		15.87	75	55	14	■		BH6-D15.87-75
		16	75	55	14	■		BH6-D16-75
		19.05	90	70	17	■		BH6-D19.05-90
		20	90	70	18	■		BH6-D20-90
		20	90	70	18		■	BH6-D20-90-F4
		20	160	140	18		■	BH6-D20-160-F4
		22	90	70	20	■		BH6-D22-90
		22	90	70	20		■	BH6-D22-90-F4
		22	130	110	20		■	BH6-D22-130-F4
		25	100	80	23	■		BH6-D25-100
		25	100	80	23		■	BH6-D25-100-F4
		25	170	150	23		■	BH6-D25-170-F4
		25.4	100	80	23.4	■		BH6-D25.4-100
28	100	80	26	■		BH6-D28-100		

Pièces de rechange
Ersatzteile
Spare parts



Art. N°

BH6...

BH6-M12

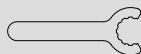

Art. N°

C-BH6-M12

Option



Art. N°

BH6...

J-M8x1-D6

■ = disponible / verfügbar / available

□ = selon disponibilité du stock / jenach Lagerverfügbarkeit / depending the stock availability

Porte-outils avec arrosage multiple
 Halter mit mehrfaches Kühlungssystem
 Tool holders with multiple coolant system

BHS4...

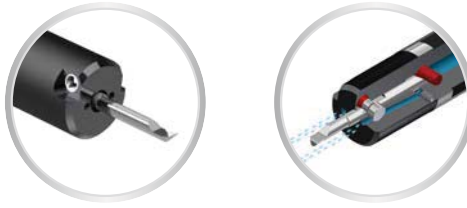

> page 10.05/10.07

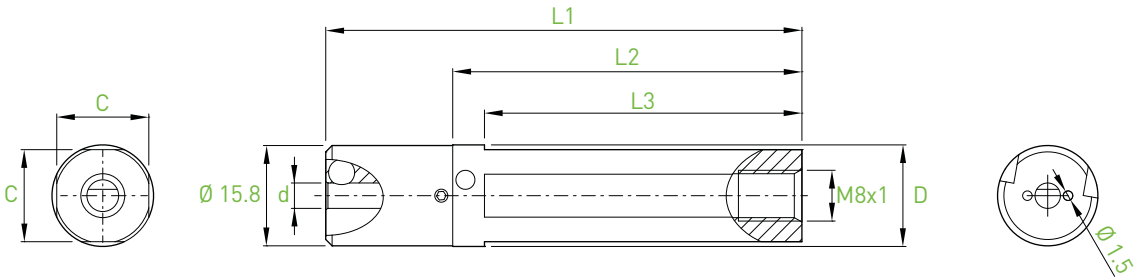

d	Bars	D	L1	L2	L3	C	Art. N°
4	BB4... BF4...	10	75	55	50	9.2	BHS4-D10-75-F4
		12	75	55	50	11	BHS4-D12-75-F4
		12.7	75	55	50	11.7	BHS4-D12.7-75-F4
		15.87	75	55	50	14.5	BHS4-D15.87-75-F4
		16	75	55	50	14.5	BHS4-D16-75-F4
		16	110	90	85	14.5	BHS4-D16-110-F4
		19.05	90	70	65	17	BHS4-D19.05-90-F4
		20	90	70	65	18	BHS4-D20-90-F4
		20	160	140	135	18	BHS4-D20-160-F4
		22	90	70	65	20	BHS4-D22-90-F4
		22	130	110	105	20	BHS4-D22-130-F4
		25	100	80	75	23	BHS4-D25-100-F4
		25	170	150	145	23	BHS4-D25-170-F4
		25.4	100	80	75	23	BHS4-D25.4-100-F4
28	100	80	75	26	BHS4-D28-100-F4		

Pièces de rechange
 Ersatzteile
 Spare parts

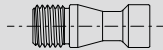

Art. N°

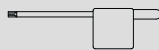

Art. N°

BHS4...

V-BHS-M4x0.5-T8

C-T8

Option

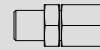

Art. N°

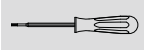

Art. N°

BHS4...

J-M8x1-D6

SET-NM1.2-TX8

Porte-outils avec arrosage multiple
 Halter mit mehrfaches Kühlungssystem
 Tool holders with multiple coolant system

BHS6...



> page 10.05/10.07

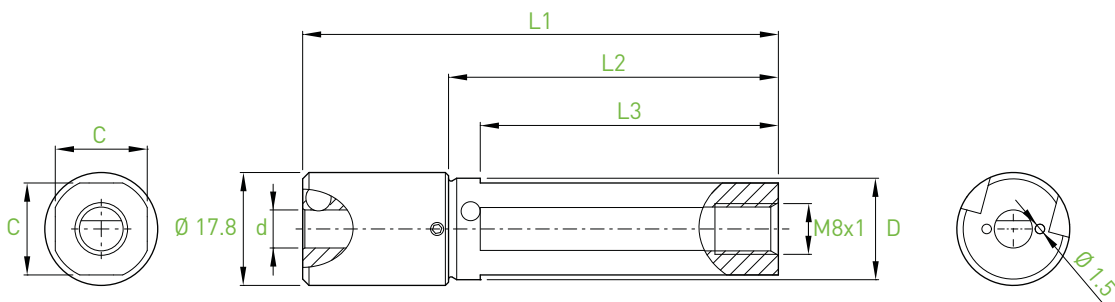

d	Bars	D	L1	L2	L3	C	Art. N°
6	BB6... BF6...	12	75	52	47	11	BHS6-D12-75-F4
		12.7	75	52	47	11.7	BHS6-D12.7-75-F4
		15.87	75	52	47	14.5	BHS6-D15.87-75-F4
		16	75	52	47	14.5	BHS6-D16-75-F4
		16	110	87	82	14.5	BHS6-D16-110-F4
		19.05	90	67	62	17	BHS6-D19.05-90-F4
		20	90	67	62	18	BHS6-D20-90-F4
		20	160	137	132	18	BHS6-D20-160-F4
		22	90	67	62	20	BHS6-D22-90-F4
		22	130	107	102	20	BHS6-D22-130-F4
		25	100	77	72	23	BHS6-D25-100-F4
		25	170	147	142	23	BHS6-D25-170-F4
		25.4	100	77	72	23	BHS6-D25.4-100-F4
28	100	77	72	26	BHS6-D28-100-F4		

Pièces de rechange Ersatzteile Spare parts	Art. N°	Art. N°
BHS6...	V-BHS-M4x0.5-T8	C-T8

Option	Art. N°	Art. N°
BHS6...	J-M8x1-D6	SET-NM1.2-TX8

Porte-outils à serrage hydraulique
 Halter mit Hydro-Dehnspann-System
 Tool holders with hydraulic clamping system

BHY4...

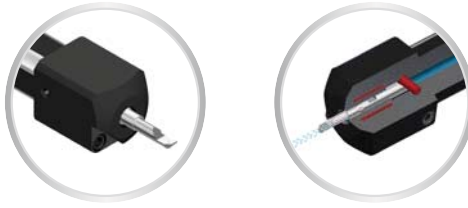

> page 10.06

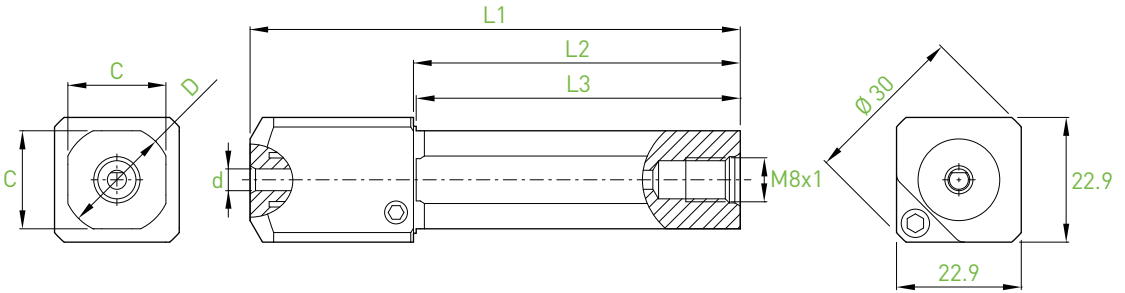

d	Bars	D	L1	L2	L3	C	Art. N°
4	BB4... BF4...	12	90	60	59.5	11.2	BHY4-D12-90-F4
		16	90	60	59.5	14.5	BHY4-D16-90-F4
		19.05	90	60	59.5	17	BHY4-D19.05-90-F4
		20	90	60	59.5	18	BHY4-D20-90-F4
		22	90	60	59.5	20	BHY4-D22-90-F4
		25	100	70	70	23	BHY4-D25-100-F4

Pièces de rechange
 Ersatzteile
 Spare parts

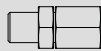

Art. N°

BHY4...

J-M8x1-D6



Art. N°

C-6P-3.0

Porte-outils à serrage hydraulique
 Halter mit Hydro-Dehnspann-System
 Tool holders with hydraulic clamping system

BHY6...

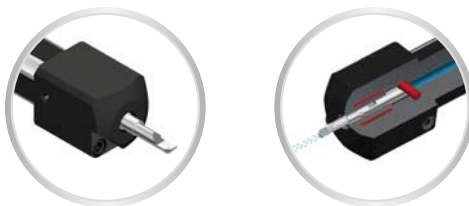

> page 10.06

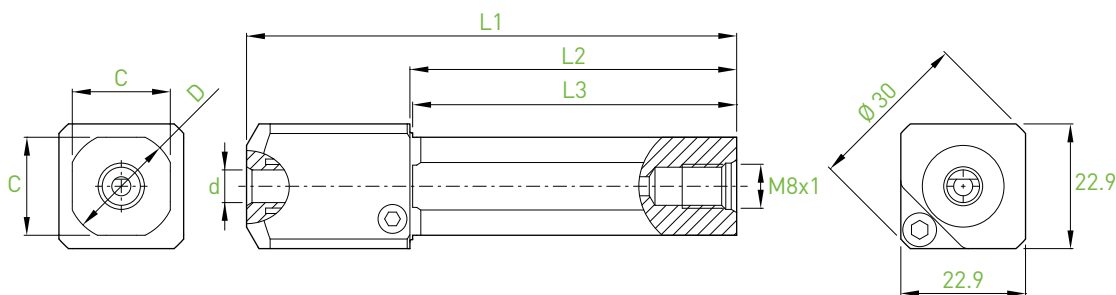

d	Bars	D	L1	L2	L3	C	Art. N°
6	BB6... BF6...	12	90	60	59.5	11.2	BHY6-D12-90-F4
		16	90	60	59.5	14.5	BHY6-D16-90-F4
		19.05	90	60	59.5	17	BHY6-D19.05-90-F4
		20	90	60	59.5	18	BHY6-D20-90-F4
		22	90	60	59.5	20	BHY6-D22-90-F4
		25	100	70	70	23	BHY6-D25-100-F4

Pièces de rechange Ersatzteile Spare parts		
	Art. N°	Art. N°
BHY6...	J-M8x1-D6	C-6P-3.0

> page 10.07

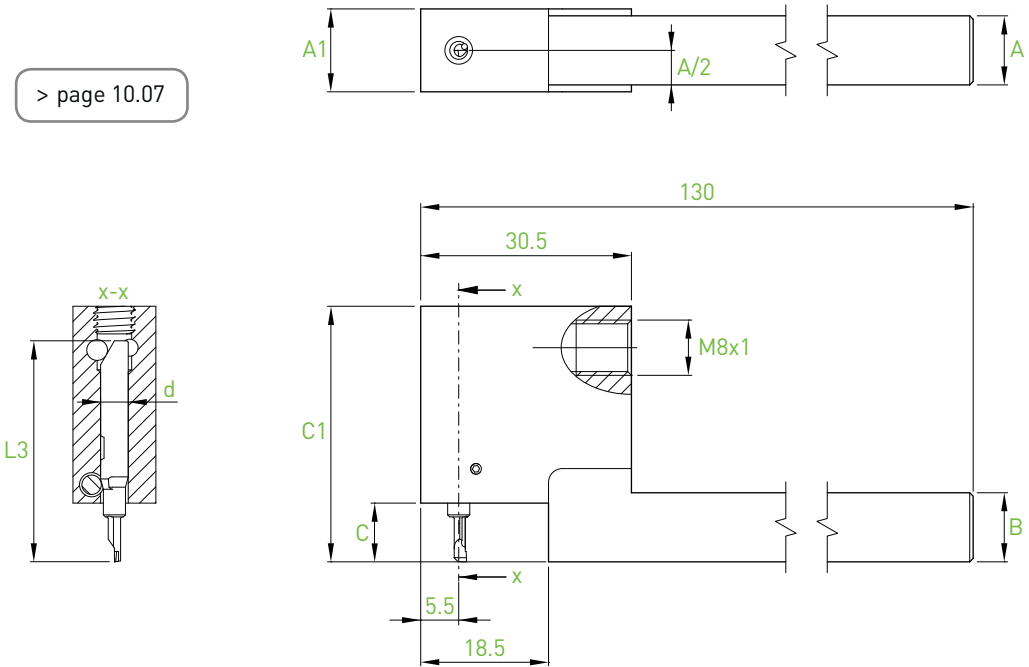

d	Compatible bars L3	A	B	C	C1	A1	Art. N°
4	32	8	8	8.5	37	12	BHK4N-0808X-32R
		10	10	8.5	37	12	BHK4N-1010X-32R
		12	12	8.5	37	12	BHK4N-1212X-32R
		16	16	8.5	37	16	BHK4N-1616X-32R
	37	8	8	13.5	42	12	BHK4N-0808X-37R
		10	10	13.5	42	12	BHK4N-1010X-37R
		12	12	13.5	42	12	BHK4N-1212X-37R
		16	16	13.5	42	16	BHK4N-1616X-37R
	42	10	10	18.5	47	12	BHK4N-1010X-42R
		12	12	18.5	47	12	BHK4N-1212X-42R
		16	16	18.5	47	16	BHK4N-1616X-42R

Pièces de rechange Ersatzteile Spare parts	Art. N°	Art. N°
BHK4N...	V-BHK-M4x0.5-T8	C-T8

Option	Art. N°	Art. N°
BHK4N...	J-M8x1-D6	SET-NM1.2-TX8

Porte-outils coudés

Kröpfunghalter

Cranked tool holders

BHK6N...

> page 10.07

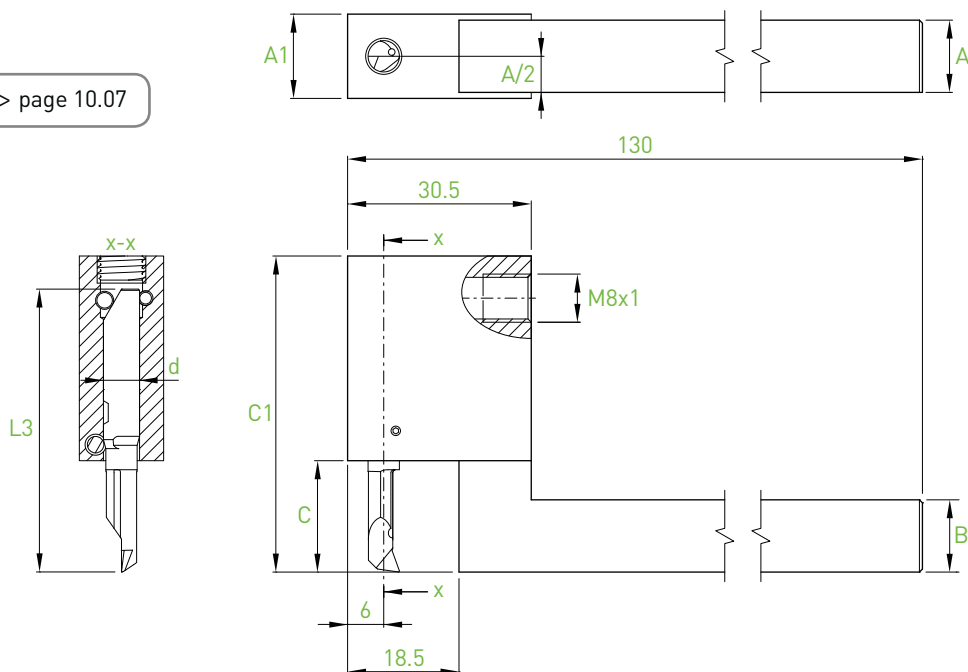

d	Compatible bars L3		A	B	C	C1	A1	Art. N°
6	BB6R...	47	10	10	18.5	52.5	12	BHK6N-1010X-47R
			12	12	18.5	52.5	12	BHK6N-1212X-47R
			16	16	18.5	52.5	16	BHK6N-1616X-47R
	BF6R...	57	10	10	28.5	62.5	12	BHK6N-1010X-57R
			12	12	28.5	62.5	12	BHK6N-1212X-57R
			16	16	28.5	62.5	16	BHK6N-1616X-57R

Pièces de rechange
Ersatzteile
Spare parts

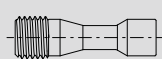

Art. N°

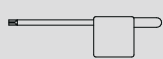

Art. N°

BHK6N...

V-BHK-M4x0.5-T8

C-T8

Option



Art. N°



Art. N°

BHK6N...

J-M8x1-D6

SET-NM1.2-TX8

IN-LINE

Alésage
Ausbohren
Boring



BB4...

BA

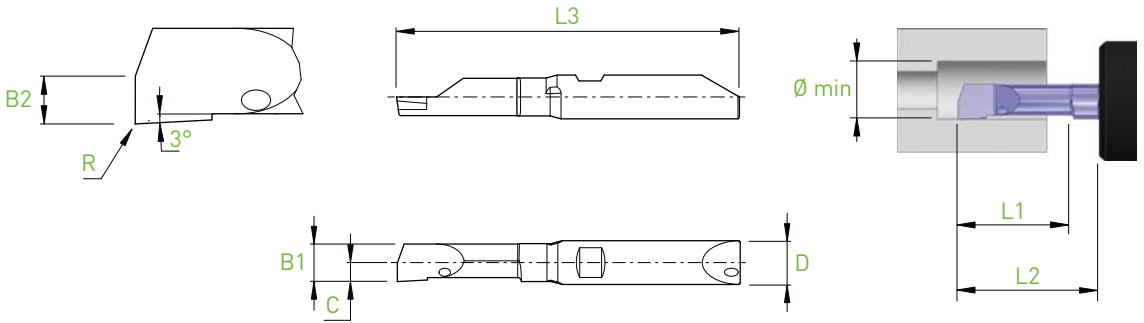

D h5	Holder	Ø min	L1	L2 BH4... BHY4...	L2 BHS4... BHK4...	B1	B2	C	R	L3	Art. N°	R		L		
												ZTAF	ZTAXF	ZN	ZTAF	ZN
4	BH4... BHS4... BHY4... BHK4...	0.3	0.9	10	8.5	0.27	0.13	0.15	0	32	BB4R/L-0309-BA	■	■	■	□	□
		0.4	1.2	10	8.5	0.36	0.18	0.20	0	32	BB4R/L-0412-BA	■	■	■	□	□
		0.5	1.5	10	8.5	0.45	0.22	0.25	0	32	BB4R/L-0515-BA	■	■	■	□	□
		1.0	3.0	10	8.5	0.90	0.45	0.60	0.02	32	BB4R/L-1030-BA-R02	■	■	■	□	□
		1.5	4.5	10	8.5	1.35	0.67	0.65	0.02	32	BB4R/L-1545-BA-R02	■	■	■	□	□
		2.0	6.0	10	8.5	1.80	0.90	1.15	0.02	32	BB4R/L-2060-BA-R02	■	■	■	□	□
		2.5	7.5	10	8.5	2.25	1.13	1.30	0.02	32	BB4R/L-2575-BA-R02	■	■	■	□	□
		3.0	9.0	15	13.5	2.70	1.35	1.35	0.05	37	BB4R/L-3090-BA-R05	■	■	■	□	□
3.5	10.5	15	13.5	3.15	1.58	1.60	0.05	37	BB4R/L-35105-BA-R05	■	■	■	□	□		

Alésage
Ausbohren
Boring



BF4...

BA

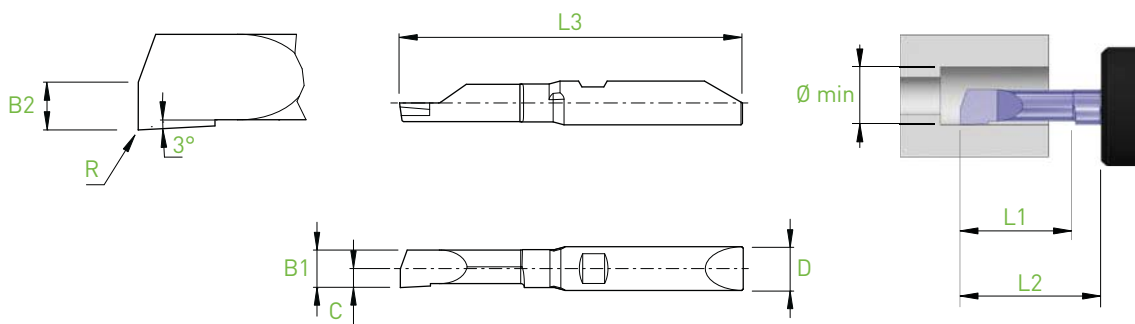

D h5	Holder	Ø min	L1	L2 BH4... BHY4...	L2 BHS4... BHK4...	B1	B2	C	R	L3	Art. N°	R		L		
												ZTAF	ZTAXF	ZN	ZTAF	ZN
4	BH4... BHS4... BHY4... BHK4...	0.3	0.9	10	8.5	0.27	0.13	0.15	0	32	BF4R/L-0309-BA	■	■	■	□	□
		0.4	1.2	10	8.5	0.36	0.18	0.20	0	32	BF4R/L-0412-BA	■	■	■	□	□
		0.5	1.5	10	8.5	0.45	0.22	0.25	0	32	BF4R/L-0515-BA	■	■	■	□	□
		1.0	3.0	10	8.5	0.90	0.45	0.60	0.02	32	BF4R/L-1030-BA-R02	■	■	■	□	□
		1.5	4.5	10	8.5	1.35	0.67	0.65	0.02	32	BF4R/L-1545-BA-R02	■	■	■	□	□
		2.0	6.0	10	8.5	1.80	0.90	1.15	0.02	32	BF4R/L-2060-BA-R02	■	■	■	□	□
		2.5	7.5	10	8.5	2.25	1.13	1.30	0.02	32	BF4R/L-2575-BA-R02	■	■	■	□	□
		3.0	9.0	15	13.5	2.70	1.35	1.35	0.05	37	BF4R/L-3090-BA-R05	■	■	■	□	□
		3.5	10.5	15	13.5	3.15	1.58	1.60	0.05	37	BF4R/L-35105-BA-R05	■	■	■	□	□

Alésage
Ausbohren
Boring



BB4... / BB6...

BAX

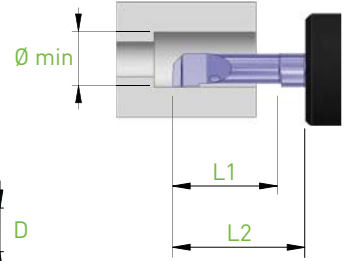
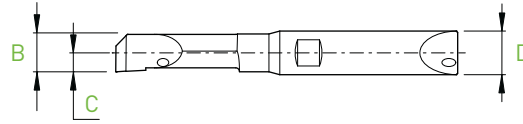
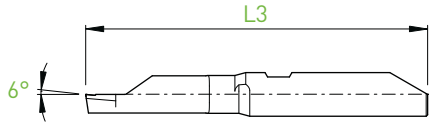
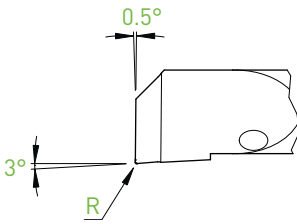

D h5	Holder	Ø min	L1	L2		B	C	R	L3	Art. N°	R		L		
				BH4... BHY4...	BHS4... BHK4...						ZTAF	ZTAXF	ZN	ZTAF	ZN
4	BH4... BHS4... BHY4... BHK4...	0.5	1.5	10	8.5	0.45	0.25	0	32	BB4R/L-0515-BAX	■	■	■	□	□
		0.6	1.8	10	8.5	0.54	0.30	0	32	BB4R/L-0618-BAX	■	■	■	□	□
		0.7	2.1	10	8.5	0.63	0.35	0	32	BB4R/L-0721-BAX	■	■	■	□	□
		0.8	2.4	10	8.5	0.72	0.40	0	32	BB4R/L-0824-BAX	■	■	■	□	□
		0.9	2.7	10	8.5	0.81	0.45	0	32	BB4R/L-0927-BAX	■	■	■	□	□
		1.0	3.0	10	8.5	0.90	0.60	0.02	32	BB4R/L-1030-BAX-R02	■	■	■	□	□
			5.0	10	8.5	0.90	0.60	0.02	32	BB4R/L-1050-BAX-R02	■	■	■	□	□
		1.5	4.5	10	8.5	1.35	0.65	0.02	32	BB4R/L-1545-BAX-R02	■	■	■	□	□
			7.5	10	8.5	1.35	0.65	0.02	32	BB4R/L-1575-BAX-R02	■	■	■	□	□
		2.0	6.0	10	8.5	1.80	1.15	0.02	32	BB4R/L-2060-BAX-R02	■	■	■	□	□
			10.0	15	13.5	1.80	1.15	0.02	37	BB4R/L-20100-BAX-R02	■	■	■	□	□
		2.5	7.5	10	8.5	2.25	1.30	0.05	32	BB4R/L-2575-BAX-R05	■	■	■	□	□
			12.5	15	13.5	2.25	1.30	0.05	37	BB4R/L-25125-BAX-R05	■	■	■	□	□
		3.0	9.0	15	13.5	2.70	1.35	0.05	37	BB4R/L-3090-BAX-R05	■	■	■	□	□
15.0	20		18.5	2.70	1.35	0.05	42	BB4R/L-30150-BAX-R05	■	■	■	□	□		
3.5	10.5	15	13.5	3.15	1.60	0.05	37	BB4R/L-35105-BAX-R05	■	■	■	□	□		
	17.5	20	18.5	3.15	1.60	0.05	42	BB4R/L-35175-BAX-R05	■	■	■	□	□		

D h5	Holder	Ø min	L1	L2		B	C	R	L3	Art. N°	R		L		
				BH6... BHY6...	BHS6... BHK6...						ZTAF	ZTAXF	ZN	ZTAF	ZN
6	BH6... BHS6... BHY6... BHK6...	4.0	12.0	20	18.5	3.80	2.20	0.05	47	BB6R/L-40120-BAX-R05	■	■	■	□	□
			20.0	30	28.5	3.80	2.20	0.05	57	BB6R/L-40200-BAX-R05	■	■	■	□	□
		4.5	13.5	20	18.5	4.28	2.30	0.05	47	BB6R/L-45135-BAX-R05	■	■	■	□	□
			22.5	30	28.5	4.28	2.30	0.05	57	BB6R/L-45225-BAX-R05	■	■	■	□	□
		5.0	15.0	20	18.5	4.75	2.40	0.05	47	BB6R/L-50150-BAX-R05	■	■	■	□	□
			25.0	30	28.5	4.75	2.40	0.05	57	BB6R/L-50250-BAX-R05	■	■	■	□	□
		5.5	16.5	20	18.5	5.15	2.60	0.05	47	BB6R/L-55165-BAX-R05	■	■	■	□	□
			27.5	30	28.5	5.15	2.60	0.05	57	BB6R/L-55275-BAX-R05	■	■	■	□	□

Alésage
Ausbohren
Boring



BF4... / BF6...

BAX

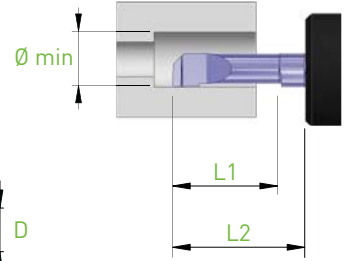
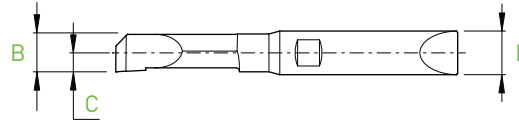
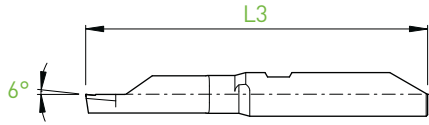
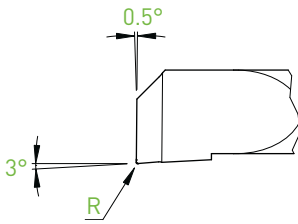

D h5	Holder	Ø min	L1	L2		B	C	R	L3	Art. N°	R		L		
				BH4... BHY4...	BHS4... BHK4...						ZTAF	ZTAXF	ZN	ZTAF	ZN
4	BH4... BHS4... BHY4... BHK4...	0.5	1.5	10	8.5	0.45	0.25	0	32	BF4R/L-0515-BAX	■	■	■	□	□
		0.6	1.8	10	8.5	0.54	0.30	0	32	BF4R/L-0618-BAX	■	■	■	□	□
		0.7	2.1	10	8.5	0.63	0.35	0	32	BF4R/L-0721-BAX	■	■	■	□	□
		0.8	2.4	10	8.5	0.72	0.40	0	32	BF4R/L-0824-BAX	■	■	■	□	□
		0.9	2.7	10	8.5	0.81	0.45	0	32	BF4R/L-0927-BAX	■	■	■	□	□
		1.0	3.0	10	8.5	0.90	0.60	0.02	32	BF4R/L-1030-BAX-R02	■	■	■	□	□
			5.0	10	8.5	0.90	0.60	0.02	32	BF4R/L-1050-BAX-R02	■	■	■	□	□
		1.5	4.5	10	8.5	1.35	0.65	0.02	32	BF4R/L-1545-BAX-R02	■	■	■	□	□
			7.5	10	8.5	1.35	0.65	0.02	32	BF4R/L-1575-BAX-R02	■	■	■	□	□
		2.0	6.0	10	8.5	1.80	1.15	0.02	32	BF4R/L-2060-BAX-R02	■	■	■	□	□
			10.0	15	13.5	1.80	1.15	0.02	37	BF4R/L-20100-BAX-R02	■	■	■	□	□
		2.5	7.5	10	8.5	2.25	1.30	0.05	32	BF4R/L-2575-BAX-R05	■	■	■	□	□
			12.5	15	13.5	2.25	1.30	0.05	37	BF4R/L-25125-BAX-R05	■	■	■	□	□
		3.0	9.0	15	13.5	2.70	1.35	0.05	37	BF4R/L-3090-BAX-R05	■	■	■	□	□
15.0	20		18.5	2.70	1.35	0.05	42	BF4R/L-30150-BAX-R05	■	■	■	□	□		
3.5	10.5	15	13.5	3.15	1.60	0.05	37	BF4R/L-35105-BAX-R05	■	■	■	□	□		
	17.5	20	18.5	3.15	1.60	0.05	42	BF4R/L-35175-BAX-R05	■	■	■	□	□		

D h5	Holder	Ø min	L1	L2		B	C	R	L3	Art. N°	R		L		
				BH6... BHY6...	BHS6... BHK6...						ZTAF	ZTAXF	ZN	ZTAF	ZN
6	BH6... BHS6... BHY6... BHK6...	4.0	12.0	20	18.5	3.80	2.20	0.05	47	BF6R/L-40120-BAX-R05	■	■	■	□	□
			20.0	30	28.5	3.80	2.20	0.05	57	BF6R/L-40200-BAX-R05	■	■	■	□	□
		4.5	13.5	20	18.5	4.28	2.30	0.05	47	BF6R/L-45135-BAX-R05	■	■	■	□	□
			22.5	30	28.5	4.28	2.30	0.05	57	BF6R/L-45225-BAX-R05	■	■	■	□	□
		5.0	15.0	20	18.5	4.75	2.40	0.05	47	BF6R/L-50150-BAX-R05	■	■	■	□	□
			25.0	30	28.5	4.75	2.40	0.05	57	BF6R/L-50250-BAX-R05	■	■	■	□	□
		5.5	16.5	20	18.5	5.15	2.60	0.05	47	BF6R/L-55165-BAX-R05	■	■	■	□	□
			27.5	30	28.5	5.15	2.60	0.05	57	BF6R/L-55275-BAX-R05	■	■	■	□	□

■ = disponible / verfügbar / available
□ = selon disponibilité du stock / jenach Lagerverfügbarkeit / depending the stock availability

IN-LINE

- Alésage-copiage
- Ausbohren-kopieren
- Boring chambering



BB4... / BB6...

BCX

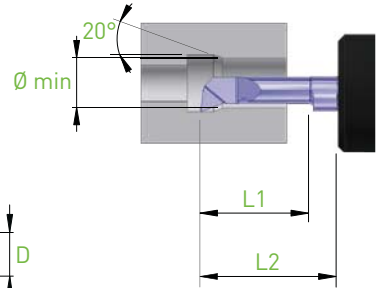
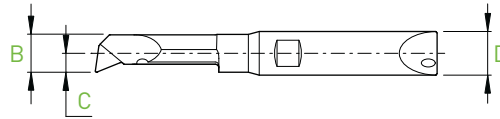
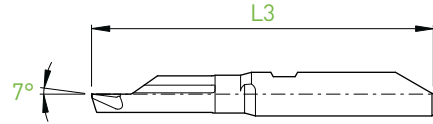
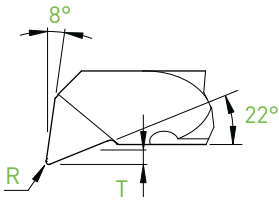

D _{h5}	Holder	Ø min	L1	L2 BH4... BHY4...	L2 BHS4... BHK4...	T	B	C	R	L3	Art. N°	R		L		
												ZTAF	ZTAXF	ZN	ZTAF	ZN
4	BH4... BHS4... BHY4... BHK4...	1.0	3.0	10	8.5	0.15	0.90	0.70	0.05	32	BB4R/L-1030-BCX-R05	■	■	■	□	□
			5.0	10	8.5	0.15	0.90	0.70	0.05	32	BB4R/L-1050-BCX-R05	■	■	■	□	□
		1.5	4.5	10	8.5	0.23	1.35	0.75	0.05	32	BB4R/L-1545-BCX-R05	■	■	■	□	□
			7.5	10	8.5	0.23	1.35	0.75	0.05	32	BB4R/L-1575-BCX-R05	■	■	■	□	□
		2.0	6.0	10	8.5	0.30	1.80	1.15	0.05	32	BB4R/L-2060-BCX-R05	■	■	■	□	□
			10.0	15	13.5	0.30	1.80	1.15	0.05	37	BB4R/L-20100-BCX-R05	■	■	■	□	□
		2.5	7.5	10	8.5	0.38	2.25	1.30	0.10	32	BB4R/L-2575-BCX-R10	■	■	■	□	□
			12.5	15	13.5	0.38	2.25	1.30	0.10	37	BB4R/L-25125-BCX-R10	■	■	■	□	□
		3.0	9.0	15	13.5	0.45	2.70	1.35	0.10	37	BB4R/L-3090-BCX-R10	■	■	■	□	□
			15.0	20	18.5	0.45	2.70	1.35	0.10	42	BB4R/L-30150-BCX-R10	■	■	■	□	□
		3.5	10.5	15	13.5	0.53	3.15	1.60	0.10	37	BB4R/L-35105-BCX-R10	■	■	■	□	□
			17.5	20	18.5	0.53	3.15	1.60	0.10	42	BB4R/L-35175-BCX-R10	■	■	■	□	□
6	BH6... BHS6... BHY6... BHK6...	4.0	12.0	20	18.5	0.60	3.80	2.20	0.15	47	BB6R/L-40120-BCX-R15	■	■	■	□	□
			20.0	30	28.5	0.60	3.80	2.20	0.15	57	BB6R/L-40200-BCX-R15	■	■	■	□	□
		4.5	13.5	20	18.5	0.68	4.28	2.30	0.15	47	BB6R/L-45135-BCX-R15	■	■	■	□	□
			22.5	30	28.5	0.68	4.28	2.30	0.15	57	BB6R/L-45225-BCX-R15	■	■	■	□	□
		5.0	15.0	20	18.5	0.75	4.75	2.40	0.15	47	BB6R/L-50150-BCX-R15	■	■	■	□	□
			25.0	30	28.5	0.75	4.75	2.40	0.15	57	BB6R/L-50250-BCX-R15	■	■	■	□	□
		5.5	16.5	20	18.5	0.83	5.15	2.60	0.15	47	BB6R/L-55165-BCX-R15	■	■	■	□	□
			27.5	30	28.5	0.83	5.15	2.60	0.15	57	BB6R/L-55275-BCX-R15	■	■	■	□	□

Alésage-copiage
 Ausbohren-kopieren
 Boring chambering

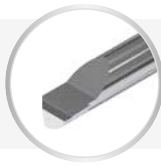

BF4... / BF6...

BCX

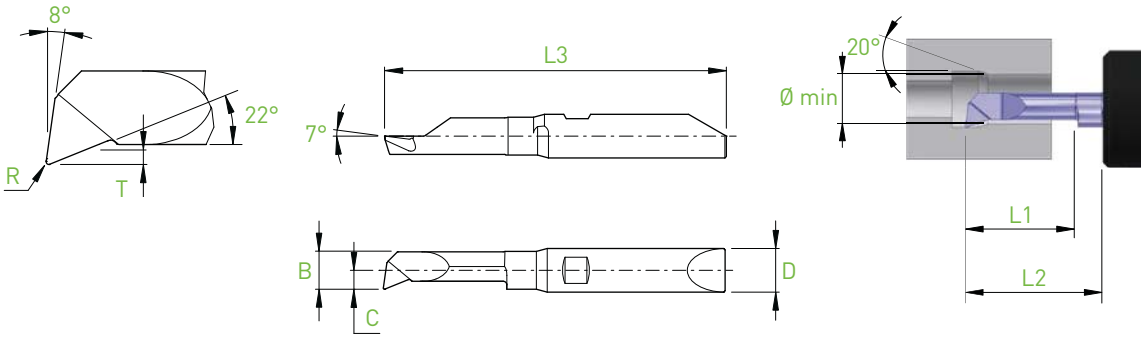

D _{h5}	Holder	Ø min	L1	L2 BH4... BHY4...	L2 BHS4... BHK4...	T	B	C	R	L3	Art. N°	R		L		
												ZTAF	ZTAXF	ZN	ZTAF	ZN
4	BH4... BHS4... BHY4... BHK4...	1.0	3.0	10	8.5	0.15	0.90	0.70	0.05	32	BF4R/L-1030-BCX-R05	■	■	■	□	□
			5.0	10	8.5	0.15	0.90	0.70	0.05	32	BF4R/L-1050-BCX-R05	■	■	■	□	□
		1.5	4.5	10	8.5	0.23	1.35	0.75	0.05	32	BF4R/L-1545-BCX-R05	■	■	■	□	□
			7.5	10	8.5	0.23	1.35	0.75	0.05	32	BF4R/L-1575-BCX-R05	■	■	■	□	□
		2.0	6.0	10	8.5	0.30	1.80	1.15	0.05	32	BF4R/L-2060-BCX-R05	■	■	■	□	□
			10.0	15	13.5	0.30	1.80	1.15	0.05	37	BF4R/L-20100-BCX-R05	■	■	■	□	□
		2.5	7.5	10	8.5	0.38	2.25	1.30	0.10	32	BF4R/L-2575-BCX-R10	■	■	■	□	□
			12.5	15	13.5	0.38	2.25	1.30	0.10	37	BF4R/L-25125-BCX-R10	■	■	■	□	□
		3.0	9.0	15	13.5	0.45	2.70	1.35	0.10	37	BF4R/L-3090-BCX-R10	■	■	■	□	□
			15.0	20	18.5	0.45	2.70	1.35	0.10	42	BF4R/L-30150-BCX-R10	■	■	■	□	□
		3.5	10.5	15	13.5	0.53	3.15	1.60	0.10	37	BF4R/L-35105-BCX-R10	■	■	■	□	□
			17.5	20	18.5	0.53	3.15	1.60	0.10	42	BF4R/L-35175-BCX-R10	■	■	■	□	□

D _{h5}	Holder	Ø min	L1	L2 BH6... BHY6...	L2 BHS6... BHK6...	T	B	C	R	L3	Art. N°	R		L		
												ZTAF	ZTAXF	ZN	ZTAF	ZN
6	BH6... BHS6... BHY6... BHK6...	4.0	12.0	20	18.5	0.60	3.80	2.20	0.15	47	BF6R/L-40120-BCX-R15	■	■	■	□	□
			20.0	30	28.5	0.60	3.80	2.20	0.15	57	BF6R/L-40200-BCX-R15	■	■	■	□	□
		4.5	13.5	20	18.5	0.68	4.28	2.30	0.15	47	BF6R/L-45135-BCX-R15	■	■	■	□	□
			22.5	30	28.5	0.68	4.28	2.30	0.15	57	BF6R/L-45225-BCX-R15	■	■	■	□	□
		5.0	15.0	20	18.5	0.75	4.75	2.40	0.15	47	BF6R/L-50150-BCX-R15	■	■	■	□	□
			25.0	30	28.5	0.75	4.75	2.40	0.15	57	BF6R/L-50250-BCX-R15	■	■	■	□	□
		5.5	16.5	20	18.5	0.83	5.15	2.60	0.15	47	BF6R/L-55165-BCX-R15	■	■	■	□	□
			27.5	30	28.5	0.83	5.15	2.60	0.15	57	BF6R/L-55275-BCX-R15	■	■	■	□	□

■ = disponible / verfügbar / available
 □ = selon disponibilité du stock / jenach Lagerverfügbarkeit / depending the stock availability

- Copiage
- Kopieren
- Chambering

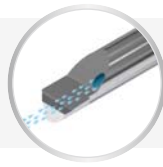

BB4... / BB6...

C45

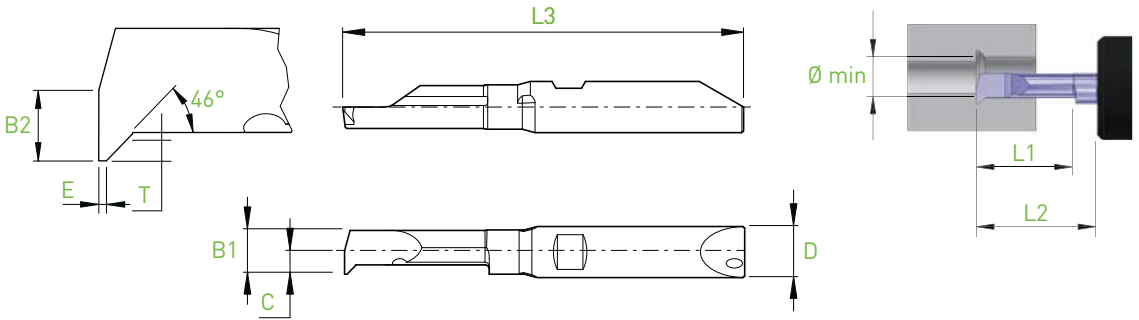

D h5	Holder	Ø min	L1	L2 BH4... BHY4...	L2 BHS4... BHK4...	T	B1	B2	C	E	L3	Art. N°	R		L		
													ZTAF	ZTAXF	ZN	ZTAF	ZN
4	BH4... BHS4... BHY4... BHK4...	0.3	0.6	10	8.5	0.05	0.27	0.13	0.15	0.03	32	BB4R/L-0306-C45-E03	■	■	■	□	□
		0.4	0.8	10	8.5	0.07	0.36	0.18	0.20	0.03	32	BB4R/L-0408-C45-E03	■	■	■	□	□
		0.5	1.0	10	8.5	0.08	0.45	0.22	0.25	0.03	32	BB4R/L-0510-C45-E03	■	■	■	□	□
		0.6	1.2	10	8.5	0.10	0.54	0.27	0.30	0.03	32	BB4R/L-0612-C45-E03	■	■	■	□	□
		0.7	1.2	10	8.5	0.12	0.63	0.32	0.35	0.03	32	BB4R/L-0714-C45-E03	■	■	■	□	□
		0.8	1.6	10	8.5	0.14	0.72	0.36	0.40	0.05	32	BB4R/L-0816-C45-E05	■	■	■	□	□
		0.9	1.8	10	8.5	0.15	0.81	0.41	0.45	0.05	32	BB4R/L-0918-C45-E05	■	■	■	□	□
		1.0	3.0	10	8.5	0.17	0.90	0.45	0.70	0.10	32	BB4R/L-1030-C45-E10	■	■	■	□	□
		1.5	4.5	10	8.5	0.25	1.35	0.67	0.75	0.10	32	BB4R/L-1545-C45-E10	■	■	■	□	□
		2.0	6.0	10	8.5	0.34	1.80	0.90	1.15	0.20	32	BB4R/L-2060-C45-E20	■	■	■	□	□
		2.5	7.5	10	8.5	0.43	2.25	1.13	1.30	0.20	32	BB4R/L-2575-C45-E20	■	■	■	□	□
3.0	9.0	15	13.5	0.51	2.70	1.35	1.35	0.30	37	BB4R/L-3090-C45-E30	■	■	■	□	□		
3.5	10.5	15	13.5	0.60	3.15	1.58	1.60	0.30	37	BB4R/L-35105-C45-E30	■	■	■	□	□		
D h5	Holder	Ø min	L1	L2 BH6... BHY6...	L2 BHS6... BHK6...	T	B1	B2	C	E	L3	Art. N°	ZTAF	ZTAXF	ZN	ZTAF	ZN
6	BH6... BHS6... BHY6... BHK6...	4.0	12.0	20	18.5	0.68	3.80	1.90	2.30	0.40	47	BB6R/L-40120-C45-E40	■	■	■	□	□
		5.0	15.0	20	18.5	0.85	4.75	2.37	2.50	0.50	47	BB6R/L-50150-C45-E50	■	■	■	□	□

Copiage
Kopieren
Chamfering

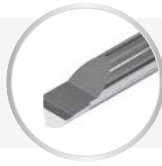

BF4... / BF6...

C45

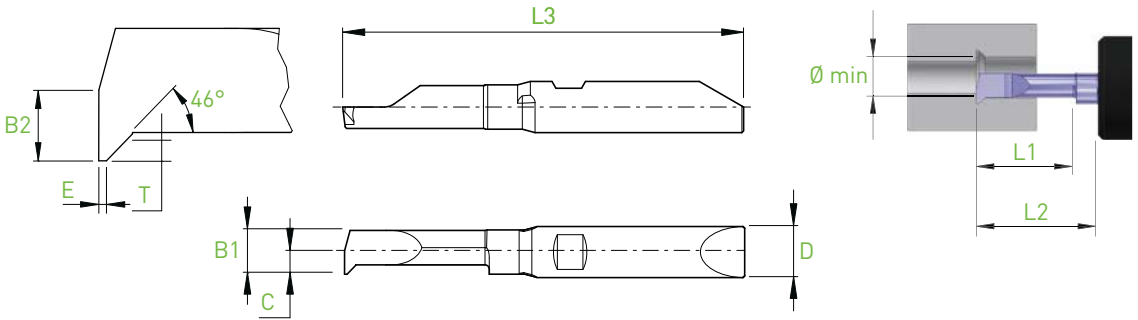

D h5	Holder	Ø min	L1	L2 BH4... BHY4...	L2 BHS4... BHK4...	T	B1	B2	C	E	L3	Art. N°	R		L		
													ZTAF	ZTAXF	ZN	ZTAF	ZN
4	BH4... BHS4... BHY4... BHK4...	0.3	0.6	10	8.5	0.05	0.27	0.13	0.15	0.03	32	BF4R/L-0306-C45-E03	■	■	■	□	□
		0.4	0.8	10	8.5	0.07	0.36	0.18	0.20	0.03	32	BF4R/L-0408-C45-E03	■	■	■	□	□
		0.5	1.0	10	8.5	0.08	0.45	0.22	0.25	0.03	32	BF4R/L-0510-C45-E03	■	■	■	□	□
		0.6	1.2	10	8.5	0.10	0.54	0.27	0.30	0.03	32	BF4R/L-0612-C45-E03	■	■	■	□	□
		0.7	1.2	10	8.5	0.12	0.63	0.32	0.35	0.03	32	BF4R/L-0714-C45-E03	■	■	■	□	□
		0.8	1.6	10	8.5	0.14	0.72	0.36	0.40	0.05	32	BF4R/L-0816-C45-E05	■	■	■	□	□
		0.9	1.8	10	8.5	0.15	0.81	0.41	0.45	0.05	32	BF4R/L-0918-C45-E05	■	■	■	□	□
		1.0	3.0	10	8.5	0.17	0.90	0.45	0.70	0.10	32	BF4R/L-1030-C45-E10	■	■	■	□	□
		1.5	4.5	10	8.5	0.25	1.35	0.67	0.75	0.10	32	BF4R/L-1545-C45-E10	■	■	■	□	□
		2.0	6.0	10	8.5	0.34	1.80	0.90	1.15	0.20	32	BF4R/L-2060-C45-E20	■	■	■	□	□
2.5	7.5	10	8.5	0.43	2.25	1.13	1.30	0.20	32	BF4R/L-2575-C45-E20	■	■	■	□	□		
3.0	9.0	15	13.5	0.51	2.70	1.35	1.35	0.30	37	BF4R/L-3090-C45-E30	■	■	■	□	□		
3.5	10.5	15	13.5	0.60	3.15	1.58	1.60	0.30	37	BF4R/L-35105-C45-E30	■	■	■	□	□		
D h5	Holder	Ø min	L1	L2 BH6... BHY6...	L2 BHS6... BHK6...	T	B1	B2	C	E	L3	Art. N°	ZTAF	ZTAXF	ZN	ZTAF	ZN
6	BH6... BHS6... BHY6... BHK6...	4.0	12.0	20	18.5	0.68	3.80	1.90	2.30	0.40	47	BF6R/L-40120-C45-E40	■	■	■	□	□
		5.0	15.0	20	18.5	0.85	4.75	2.37	2.50	0.50	47	BF6R/L-50150-C45-E50	■	■	■	□	□

- Copiage**
- Kopieren**
- Chamfering**

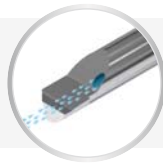

BB4... / BB6...

C45X

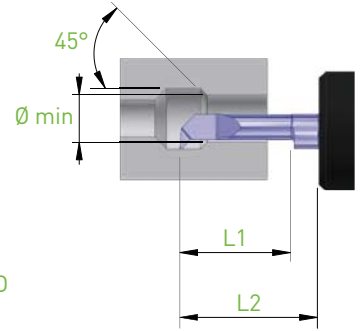
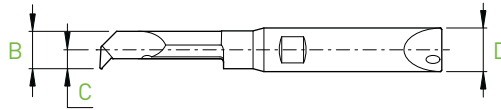
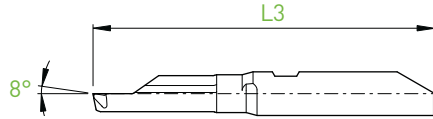
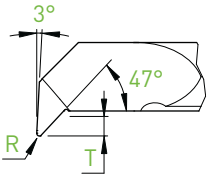

D h5	Holder	Ø min	L1	L2 BH4... BHY4...	L2 BHS4... BHK4...	T	B	C	R	L3	Art. N°	R		L		
												ZTAF	ZTAXF	ZN	ZTAF	ZN
4	BH4... BHS4... BHY4... BHK4...	2.5	7.5	10	8.5	0.50	2.25	1.35	0.10	32	BB4R/L-2575-C45X-R10	■	■	■	□	□
			12.5	15	13.5	0.50	2.25	1.35	0.10	37	BB4R/L-25125-C45X-R10	■	■	■	□	□
		3.0	9.0	15	13.5	0.60	2.70	1.45	0.10	37	BB4R/L-3090-C45X-R10	■	■	■	□	□
			15.0	20	18.5	0.60	2.70	1.45	0.10	42	BB4R/L-30150-C45X-R10	■	■	■	□	□
		3.5	10.5	15	13.5	0.70	3.15	1.60	0.10	37	BB4R/L-35105-C45X-R10	■	■	■	□	□
			17.5	20	18.5	0.70	3.15	1.60	0.10	42	BB4R/L-35175-C45X-R10	■	■	■	□	□
D h5	Holder	Ø min	L1	L2 BH6... BHY6...	L2 BHS6... BHK6...	T	B	C	R	L3	Art. N°	ZTAF	ZTAXF	ZN	ZTAF	ZN
6	BH6... BHS6... BHY6... BHK6...	4.0	12.0	20	18.5	0.80	3.80	2.30	0.15	47	BB6R/L-40120-C45X-R15	■	■	■	□	□
			20.0	30	28.5	0.80	3.80	2.30	0.15	57	BB6R/L-40200-C45X-R15	■	■	■	□	□
		4.5	13.5	20	18.5	0.90	4.28	2.40	0.15	47	BB6R/L-45135-C45X-R15	■	■	■	□	□
			22.5	30	28.5	0.90	4.28	2.40	0.15	57	BB6R/L-45225-C45X-R15	■	■	■	□	□
		5.0	15.0	20	18.5	1.00	4.75	2.50	0.15	47	BB6R/L-50150-C45X-R15	■	■	■	□	□
			25.0	30	28.5	1.00	4.75	2.50	0.15	57	BB6R/L-50250-C45X-R15	■	■	■	□	□
		5.5	16.5	20	18.5	1.10	5.15	2.60	0.15	47	BB6R/L-55165-C45X-R15	■	■	■	□	□
			27.5	30	28.5	1.10	5.15	2.60	0.15	57	BB6R/L-55275-C45X-R15	■	■	■	□	□

Copiage
Kopieren
Chambering



BF4... / BF6...

C45X

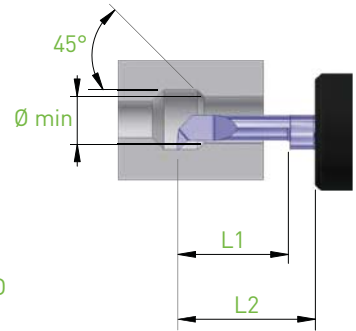
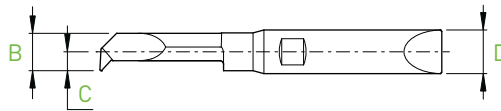
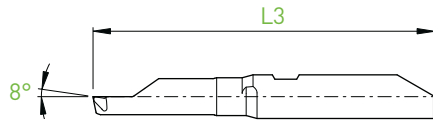
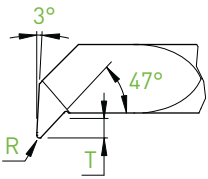

D h5	Holder	Ø min	L1	L2 BH4... BHY4...	L2 BHS4... BHK4...	T	B	C	R	L3	Art. N°	R		L		
												ZTAF	ZTAXF	ZN	ZTAF	ZN
4	BH4... BHS4... BHY4... BHK4...	2.5	7.5	10	8.5	0.50	2.25	1.35	0.10	32	BF4R/L-2575-C45X-R10	■	■	■	□	□
			12.5	15	13.5	0.50	2.25	1.35	0.10	37	BF4R/L-25125-C45X-R10	■	■	■	□	□
		3.0	9.0	15	13.5	0.60	2.70	1.45	0.10	37	BF4R/L-3090-C45X-R10	■	■	■	□	□
			15.0	20	18.5	0.60	2.70	1.45	0.10	42	BF4R/L-30150-C45X-R10	■	■	■	□	□
		3.5	10.5	15	13.5	0.70	3.15	1.60	0.10	37	BF4R/L-35105-C45X-R10	■	■	■	□	□
			17.5	20	18.5	0.70	3.15	1.60	0.10	42	BF4R/L-35175-C45X-R10	■	■	■	□	□
D h5	Holder	Ø min	L1	L2 BH6... BHY6...	L2 BHS6... BHK6...	T	B	C	R	L3	Art. N°	ZTAF	ZTAXF	ZN	ZTAF	ZN
6	BH6... BHS6... BHY6... BHK6...	4.0	12.0	20	18.5	0.80	3.80	2.30	0.15	47	BF6R/L-40120-C45X-R15	■	■	■	□	□
			20.0	30	28.5	0.80	3.80	2.30	0.15	57	BF6R/L-40200-C45X-R15	■	■	■	□	□
		4.5	13.5	20	18.5	0.90	4.28	2.40	0.15	47	BF6R/L-45135-C45X-R15	■	■	■	□	□
			22.5	30	28.5	0.90	4.28	2.40	0.15	57	BF6R/L-45225-C45X-R15	■	■	■	□	□
		5.0	15.0	20	18.5	1.00	4.75	2.50	0.15	47	BF6R/L-50150-C45X-R15	■	■	■	□	□
			25.0	30	28.5	1.00	4.75	2.50	0.15	57	BF6R/L-50250-C45X-R15	■	■	■	□	□
		5.5	16.5	20	18.5	1.10	5.15	2.60	0.15	47	BF6R/L-55165-C45X-R15	■	■	■	□	□
			27.5	30	28.5	1.10	5.15	2.60	0.15	57	BF6R/L-55275-C45X-R15	■	■	■	□	□

■ = disponible / verfügbar / available
□ = selon disponibilité du stock / jenach Lagerverfügbarkeit / depending the stock availability

Gorge
Einstecken
Grooving

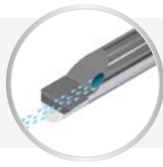

BB4... / BB6...

GX

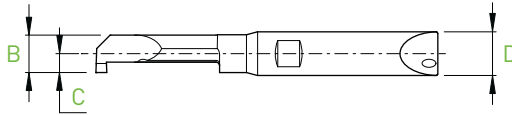
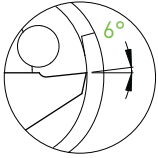
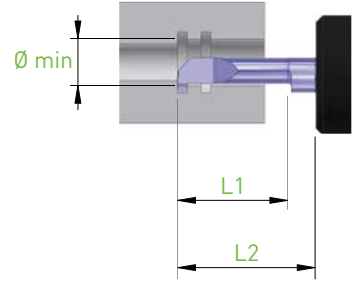
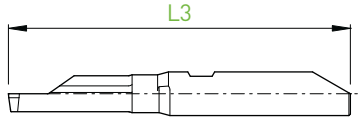
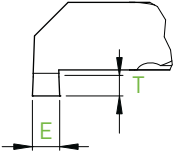

D h5	Holder	Ø min	L1	L2		E	T	B	C	L3	Art. N°	R		L		
				BH4... BHY4...	BHS4... BHK4...							ZTAF ZN	ZTAXF ZN			
4	BH4... BHS4... BHY4... BHK4...	3.0	9.0	15	13.5	0.50	0.60	2.70	1.45	37	BB4R/L-3090-G050X	■	■	■	□	□
			15.0	20	18.5	0.50	0.60	2.70	1.45	42	BB4R/L-30150-G050X	■	■	■	□	□
	3.5	10.5	15	13.5	0.75	0.70	3.15	1.60	37	BB4R/L-35105-G075X	■	■	■	□	□	
		17.5	20	18.5	0.75	0.70	3.15	1.60	42	BB4R/L-35175-G075X	■	■	■	□	□	

D h5	Holder	Ø min	L1	L2		E	T	B	C	L3	Art. N°	R		L			
				BH6... BHY6...	BHS6... BHK6...							ZTAF ZN	ZTAXF ZN				
6	BH6... BHS6... BHY6... BHK6...	4.0	12.0	20	18.5	1.00	0.80	3.80	2.20	47	BB6R/L-40120-G100X	■	■	■	□	□	
			20.0	30	28.5	1.00	0.80	3.80	2.20	57	BB6R/L-40200-G100X	■	■	■	□	□	
		4.5	13.5	20	18.5	1.00	0.90	4.28	2.40	47	BB6R/L-45135-G100X	■	■	■	□	□	
			22.5	30	28.5	1.00	0.90	4.28	2.40	57	BB6R/L-45225-G100X	■	■	■	□	□	
		5.0	15.0	20	18.5	1.00	1.00	4.75	2.50	47	BB6R/L-50150-G100X	■	■	■	□	□	
			25.0	30	28.5	1.00	1.00	4.75	2.50	57	BB6R/L-50150-G150X	■	■	■	□	□	
			5.5	16.5	20	18.5	1.00	1.10	5.15	2.60	47	BB6R/L-55165-G100X	■	■	■	□	□
							1.50					BB6R/L-55165-G150X	■	■	■	□	□
							2.00					BB6R/L-55165-G200X	■	■	■	□	□
							1.00					BB6R/L-55275-G100X	■	■	■	□	□
		27.5	30	28.5	1.50	1.10	5.15	2.60	57	BB6R/L-55275-G150X	■	■	■	□	□		
					2.00					BB6R/L-55275-G200X	■	■	■	□	□		

Gorge
Einstechen
Grooving

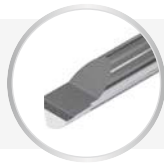

BF4... / BF6...

GX

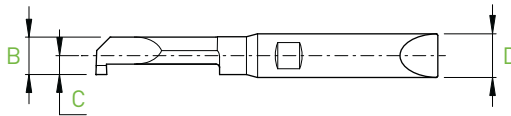
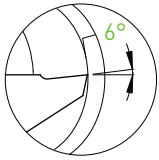
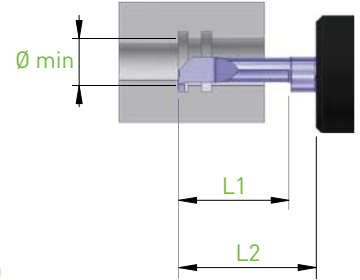
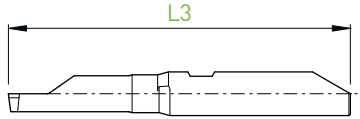
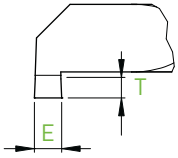

D h5	Holder	Ø min	L1	L2		E	T	B	C	L3	Art. N°	R		L			
				BH4... BHY4...	BHS4... BHK4...							ZTAF	ZTAXF	ZN	ZTAF	ZN	
4	BH4... BHS4... BHY4... BHK4...	3.0	9.0	15	13.5	0.50	0.60	2.70	1.45	37	BF4R/L-3090-G050X	■	■	■	□	□	
			15.0	20	18.5	0.50	0.60	2.70	1.45	42	BF4R/L-30150-G050X	■	■	■	□	□	
	3.5	10.5	15	13.5	0.75	0.70	3.15	1.60	37	BF4R/L-35105-G075X	■	■	■	□	□		
		17.5	20	18.5	0.75	0.70	3.15	1.60	42	BF4R/L-35175-G075X	■	■	■	□	□		
D h5	Holder	Ø min	L1	L2		E	T	B	C	L3	Art. N°	R		L			
6	BH6... BHS6... BHY6... BHK6...	4.0	12.0	20	18.5							1.00	0.80	3.80	2.20	47	BF6R/L-40120-G100X
			20.0	30	28.5	1.00	0.80	3.80	2.20	57	BF6R/L-40200-G100X	■	■	■	□	□	
		4.5	13.5	20	18.5	1.00	0.90	4.28	2.40	47	BF6R/L-45135-G100X	■	■	■	□	□	
			22.5	30	28.5	1.00	0.90	4.28	2.40	57	BF6R/L-45225-G100X	■	■	■	□	□	
		5.0	15.0	20	18.5	1.50	1.00	4.75	2.50	47	BF6R/L-50150-G100X	■	■	■	□	□	
			25.0	30	28.5	1.50	1.00	4.75	2.50	57	BF6R/L-50150-G150X	■	■	■	□	□	
			5.5	16.5	20	18.5	1.00	1.10	5.15	2.60	47	BF6R/L-55165-G100X	■	■	■	□	□
							1.50					BF6R/L-55165-G150X	■	■	■	□	□
							2.00					BF6R/L-55165-G200X	■	■	■	□	□
							1.00					BF6R/L-55275-G100X	■	■	■	□	□
		27.5	30	28.5	1.50	1.10	5.15	2.60	57	BF6R/L-55275-G150X	■	■	■	□	□		
					2.00					BF6R/L-55275-G200X	■	■	■	□	□		

■ = disponible / verfügbar / available
□ = selon disponibilité du stock / jenach Lagerverfügbarkeit / depending the stock availability

IN-LINE

Fonçage-tournage
Einstecken und drehen
Grooving and turning



BB4... / BB6...

GTX

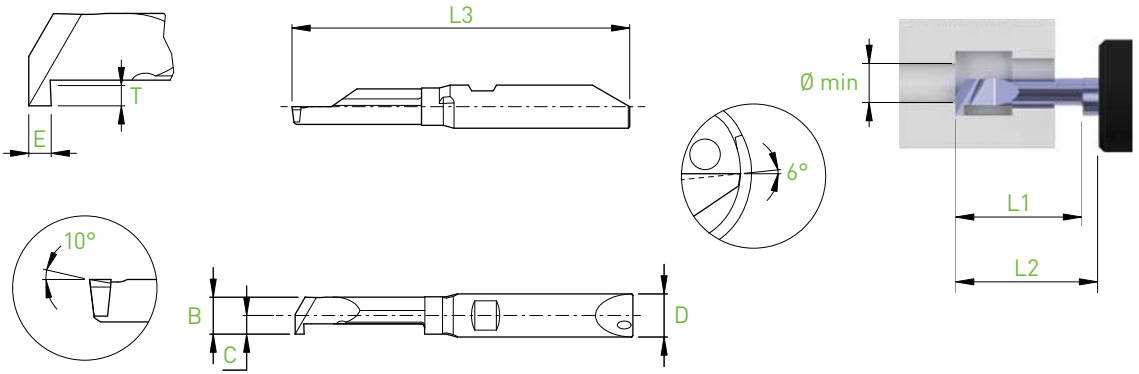

D h5	Holder	Ø min	L1	L2 BH4... BHY4...	L2 BHS4... BHK4...	E	T	B	C	L3	Art. N°	R		L		
												ZTAF	ZTAXF	ZN	ZTAF	ZN
4	BH4... BHS4... BHY4... BHK4...	3.0	9.0	15	13.5	1.00	0.60	2.7	1.45	37	BB4R/L-3090-GT100X	■	■	■	□	□
			15.0	20	18.5	1.00	0.60	2.7	1.45	42	BB4R/L-30150-GT100X	■	■	■	□	□
	3.5	10.5	15	13.5	1.00	0.70	3.15	1.6	37	BB4R/L-35105-GT100X	■	■	■	□	□	
		17.5	20	18.5	1.00	0.70	3.15	1.6	42	BB4R/L-35175-GT100X	■	■	■	□	□	
D h5	Holder	Ø min	L1	L2 BH6... BHY6...	L2 BHS6... BHK6...	E	T	B	C	L3	Art. N°	ZTAF	ZTAXF	ZN	ZTAF	ZN
6	BH6... BHS6... BHY6... BHK6...	4.0	14.0	20	18.5	1.25	0.80	3.8	2.2	47	BB6R/L-40140-GT125X	■	■	■	□	□
			22.0	30	28.5	1.25	0.80	3.8	2.2	57	BB6R/L-40220-GT125X	■	■	■	□	□
		4.5	16.0	20	18.5	1.25	0.90	4.28	2.4	47	BB6R/L-45160-GT125X	■	■	■	□	□
			25.0	30	28.5	1.25	0.90	4.28	2.4	57	BB6R/L-45250-GT125X	■	■	■	□	□
		5.0	17.5	20	18.5	1.25	1.00	4.75	2.5	47	BB6R/L-50175-GT125X	■	■	■	□	□
			27.5	30	28.5	1.25	1.00	4.75	2.5	57	BB6R/L-50275-GT125X	■	■	■	□	□
		5.5	17.5	20	18.5	1.25	1.10	5.15	2.6	47	BB6R/L-55175-GT125X	■	■	■	□	□
			27.5	30	28.5	1.25	1.10	5.15	2.6	57	BB6R/L-55275-GT125X	■	■	■	□	□

Fonçage-tournage

Einstechen und drehen

Grooving and turning

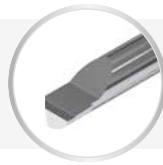

BF4... / BF6...

GTX

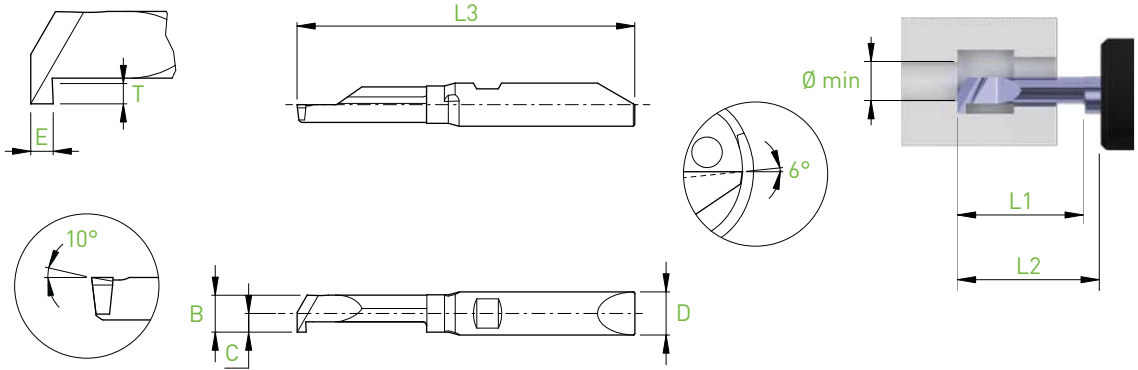

D h5	Holder	Ø min	L1	L2 BH4... BHY4...	L2 BHS4... BHK4...	E	T	B	C	L3	Art. N°	R		L		
												ZTAF	ZTAXF	ZN	ZTAF	ZN
4	BH4... BHS4... BHY4... BHK4...	3.0	9.0	15	13.5	1.00	0.60	2.7	1.45	37	BF4R/L-3090-GT100X	■	■	■	□	□
			15.0	20	18.5	1.00	0.60	2.7	1.45	42	BF4R/L-30150-GT100X	■	■	■	□	□
	3.5	10.5	15	13.5	1.00	0.70	3.15	1.6	37	BF4R/L-35105-GT100X	■	■	■	□	□	
		17.5	20	18.5	1.00	0.70	3.15	1.6	42	BF4R/L-35175-GT100X	■	■	■	□	□	
D h5	Holder	Ø min	L1	L2 BH6... BHY6...	L2 BHS6... BHK6...	E	T	B	C	L3	Art. N°	ZTAF	ZTAXF	ZN	ZTAF	ZN
6	BH6... BHS6... BHY6... BHK6...	4.0	14.0	20	18.5	1.25	0.80	3.8	2.2	47	BF6R/L-40140-GT125X	■	■	■	□	□
			22.0	30	28.5	1.25	0.80	3.8	2.2	57	BF6R/L-40220-GT125X	■	■	■	□	□
		4.5	16.0	20	18.5	1.25	0.90	4.28	2.4	47	BF6R/L-45160-GT125X	■	■	■	□	□
			25.0	30	28.5	1.25	0.90	4.28	2.4	57	BF6R/L-45250-GT125X	■	■	■	□	□
		5.0	17.5	20	18.5	1.25	1.00	4.75	2.5	47	BF6R/L-50175-GT125X	■	■	■	□	□
			27.5	30	28.5	1.25	1.00	4.75	2.5	57	BF6R/L-50275-GT125X	■	■	■	□	□
		5.5	17.5	20	18.5	1.25	1.10	5.15	2.6	47	BF6R/L-55175-GT125X	■	■	■	□	□
			27.5	30	28.5	1.25	1.10	5.15	2.6	57	BF6R/L-55275-GT125X	■	■	■	□	□

■ = disponible / verfügbar / available

□ = selon disponibilité du stock / jenach Lagerverfügbarkeit / depending the stock availability

IN-LINE

Filetage
Gewindedrehen
Threading

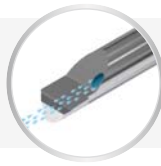

BB4... / BB6...

TP60

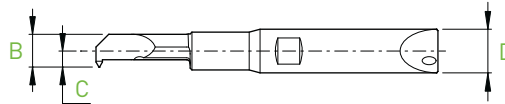
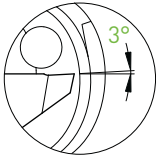
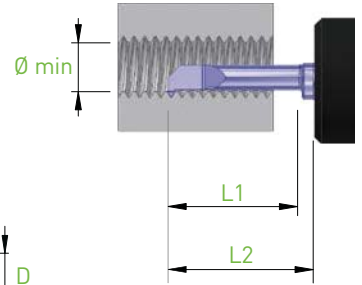
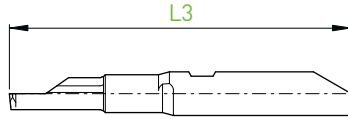
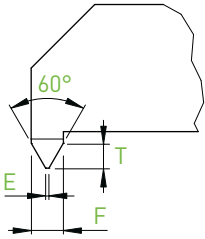

D h5	Holder	Ø min	L1	L2 BH4... BHY4...	L2 BHS4... BHK4...	P (mm)	P (TPI)	F	E (0/-0.01)	T	B	C	L3	Art. N°	R		L	
															ZTAF ZN	ZTAF ZN		
4	BH4... BHS4... BHY4... BHK4...	1.25	3.2	10	8.5	0.20-0.35	80	0.30	0.02	0.25	1.10	0.80	32	BB4R/L-1232-TP60	■	■	□	□
		1.6	4.0	10	8.5	0.25-0.40	72-64	0.35	0.03	0.28	1.41	0.90	32	BB4R/L-1640-TP60	■	■	□	□
		2.5	6.0	10	8.5	0.35-0.50	56-48	0.44	0.04	0.34	2.25	1.35	32	BB4R/L-2560-TP60	■	■	□	□
			9.0	15	13.5	0.35-0.50	56-48	0.44	0.04	0.34	2.25	1.35	37	BB4R/L-2590-TP60	■	■	□	□
		3.3	8.0	15	13.5	0.50-0.75	40-36	0.62	0.06	0.48	2.97	1.50	37	BB4R/L-3380-TP60	■	■	□	□
			12.0	15	13.5	0.50-0.75	40-36	0.62	0.06	0.48	2.97	1.50	37	BB4R/L-33120-TP60	■	■	□	□
D h5	Holder	Ø min	L1	L2 BH6... BHY6...	L2 BHS6... BHK6...	P (mm)	P (TPI)	F	E (0/-0.01)	T	B	C	L3	Art. N°	R		L	
															ZTAF ZN	ZTAF ZN		
6	BH6... BHS6... BHY6... BHK6...	4.2	10.0	20	18.5	0.50-0.80	36-32	0.70	0.06	0.55	3.78	2.10	47	BB6R/L-42100-TP60	■	■	□	□
			15.0	20	18.5	0.50-0.80	36-32	0.70	0.06	0.55	3.78	2.10	47	BB6R/L-42150-TP60	■	■	□	□
		5.0	12.0	20	18.5	0.75-1.00	28-24	0.89	0.09	0.69	4.50	2.20	47	BB6R/L-50120-TP60	■	■	□	□
			18.0	20	18.5	0.75-1.00	28-24	0.89	0.09	0.69	4.50	2.20	47	BB6R/L-50180-TP60	■	■	□	□

Filetage
Gewindedrehen
Threading

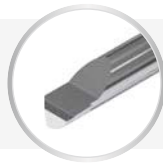

BF4... / BF6...

TP60

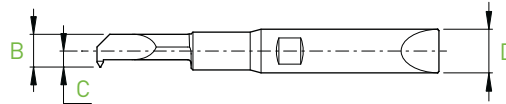
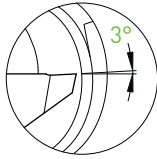
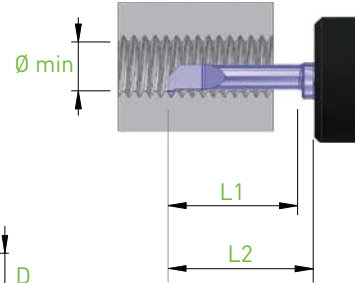
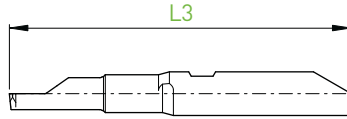
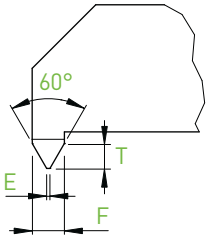

D h5	Holder	Ø min	L1	L2 BH4... BHY4...	L2 BHS4... BHK4...	P (mm)	P (TPI)	F	E (0/-0.01)	T	B	C	L3	Art. N°	R		L	
															ZTAF ZN	ZTAF ZN		
4	BH4... BHS4... BHY4... BHK4...	1.25	3.2	10	8.5	0.20-0.35	80	0.30	0.02	0.25	1.10	0.80	32	BF4R/L-1232-TP60	■	■	□	□
		1.6	4.0	10	8.5	0.25-0.40	72-64	0.35	0.03	0.28	1.41	0.90	32	BF4R/L-1640-TP60	■	■	□	□
		2.5	6.0	10	8.5	0.35-0.50	56-48	0.44	0.04	0.34	2.25	1.35	32	BF4R/L-2560-TP60	■	■	□	□
			9.0	15	13.5	0.35-0.50	56-48	0.44	0.04	0.34	2.25	1.35	37	BF4R/L-2590-TP60	■	■	□	□
		3.3	8.0	15	13.5	0.50-0.75	40-36	0.62	0.06	0.48	2.97	1.50	37	BF4R/L-3380-TP60	■	■	□	□
			12.0	15	13.5	0.50-0.75	40-36	0.62	0.06	0.48	2.97	1.50	37	BF4R/L-33120-TP60	■	■	□	□
D h5	Holder	Ø min	L1	L2 BH6... BHY6...	L2 BHS6... BHK6...	P (mm)	P (TPI)	F	E (0/-0.01)	T	B	C	L3	Art. N°	R		L	
															ZTAF ZN	ZTAF ZN		
6	BH6... BHS6... BHY6... BHK6...	4.2	10.0	20	18.5	0.50-0.80	36-32	0.70	0.06	0.55	3.78	2.10	47	BF6R/L-42100-TP60	■	■	□	□
			15.0	20	18.5	0.50-0.80	36-32	0.70	0.06	0.55	3.78	2.10	47	BF6R/L-42150-TP60	■	■	□	□
		5.0	12.0	20	18.5	0.75-1.00	28-24	0.89	0.09	0.69	4.50	2.20	47	BF6R/L-50120-TP60	■	■	□	□
			18.0	20	18.5	0.75-1.00	28-24	0.89	0.09	0.69	4.50	2.20	47	BF6R/L-50180-TP60	■	■	□	□

IN-LINE

Filetage
Gewindedrehen
Threading



BB4... / BB6...

TP55

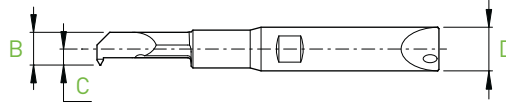
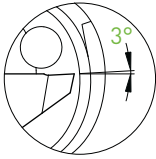
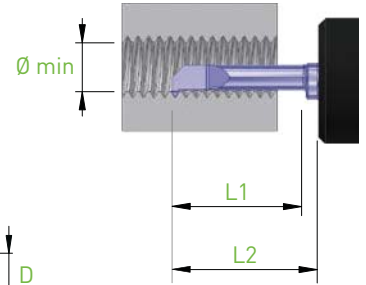
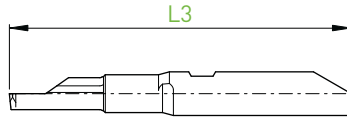
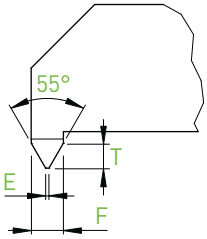

D _{h5}	Holder	Ø min	L1	L2 BH4... BHY4...	L2 BHS4... BHK4...	P (TPI)	F	E (0/-0.02)	T	B	C	L3	Art. N°	R		L	
														ZTAF ZN	ZTAF ZN	ZTAF ZN	ZTAF ZN
4	BH4...	1.85	4.5	10	8.5	48	0.54	0.09	0.44	1.67	0.97	32	BB4R/L-1845-TP55	■	■	□	□
	BHS4...																
	BHY4... BHK4...	2.55	6.0	10	8.5	40	0.64	0.10	0.52	2.25	1.35	32	BB4R/L-2560-TP55	■	■	□	□
D _{h5}	Holder	Ø min	L1	L2 BH6... BHY6...	L2 BHS6... BHK6...	P (TPI)	F	E (0/-0.02)	T	B	C	L3	Art. N°	R		L	
6	BH6...	3.70	11.0	20	18.5	32-24	1.08	0.13	0.91	3.33	1.83	47	BB6R/L-37110-TP55	■	■	□	□
	BHS6...	5.10	15.0	20	18.5	26-20	1.30	0.16	1.09	4.60	2.05	47	BB6R/L-51150-TP55	■	■	□	□
	BHY6... BHK6...	5.50	16.0	20	18.5	22-16	1.48	0.19	1.24	5.15	2.60	47	BB6R/L-55160-TP55	■	■	□	□

Filetage
Gewindedrehen
Threading

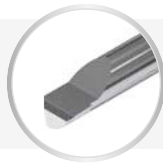

BF4... / BF6...

TP55

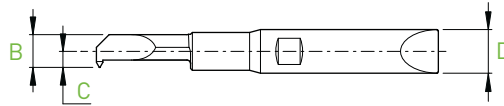
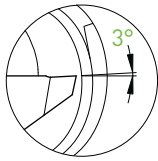
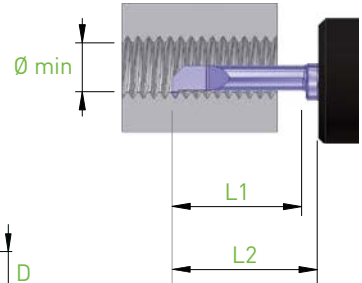
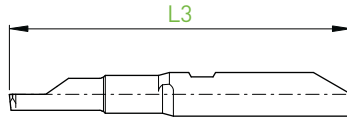
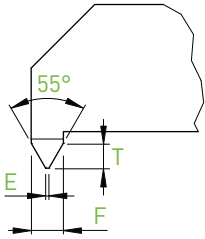

													R		L		
D _{h5}	Holder	Ø min	L1	L2 BH4... BHY4...	L2 BHS4... BHK4...	P [TPI]	F	E [0/-0.02]	T	B	C	L3	Art. N°	ZTAF ZN	ZTAF ZN		
4	BH4...	1.85	4.5	10	8.5	48	0.54	0.09	0.44	1.67	0.97	32	BF4R/L-1845-TP55	■	■	□	□
	BHS4...													■	■	□	□
	BHY4... BHK4...	2.55	6.0	10	8.5	40	0.64	0.10	0.52	2.25	1.35	32	BF4R/L-2560-TP55	■	■	□	□
D _{h5}	Holder	Ø min	L1	L2 BH6... BHY6...	L2 BHS6... BHK6...	P [TPI]	F	E [0/-0.02]	T	B	C	L3	Art. N°	ZTAF ZN	ZTAF ZN		
6	BH6...	3.70	11.0	20	18.5	32-24	1.08	0.13	0.91	3.33	1.83	47	BF6R/L-37110-TP55	■	■	□	□
	BHS6...	5.10	15.0	20	18.5	26-20	1.30	0.16	1.09	4.60	2.05	47	BF6R/L-51150-TP55	■	■	□	□
	BHY6... BHK6...	5.50	16.0	20	18.5	22-16	1.48	0.19	1.24	5.15	2.60	47	BF6R/L-55160-TP55	■	■	□	□



Profil complet métrique
Metrisches Vollprofil
Metric full profile

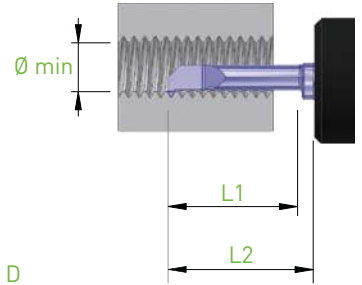
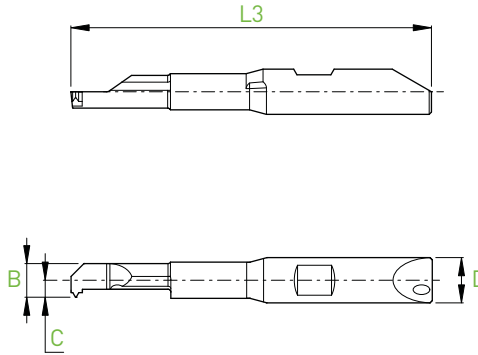
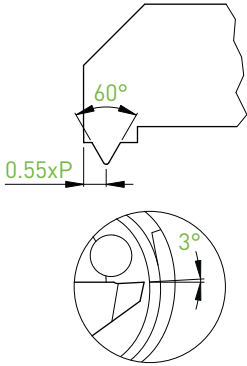

R

D h5	Holder	M (min)	Ø min	P (mm)	L1	L2 BH4... BHY4...	L2 BHS4... BHK4...	B	C	L3	Art. N°	ZTAF ZN
4	BH4... BHS4... BHY4... BHK4...	M3x0.5	2.50	0.50	6.0	10	8.5	2.25	1.35	32	BB4R-2560-TM-0.50	■ ■
		M4x0.7	3.30	0.70	8.0	15	13.5	2.97	1.50	37	BB4R-3380-TM-0.70	■ ■
D h5	Holder	M (min)	Ø min	P (mm)	L1	L2 BH6... BHY6...	L2 BHS6... BHK6...	B	C	L3	Art. N°	ZTAF ZN
6	BH6... BHS6... BHY6... BHK6...	M5x0.8	4.20	0.80	10.0	20	18.5	3.78	2.10	47	BB6R-42100-TM-0.80	■ ■
		M6x1.0	5.00	1.00	12.0	20	18.5	4.50	2.20	47	BB6R-50120-TM-1.00	■ ■

Filetage
Gewindedrehen
Threading



BF4... / BF6...

TM

Profil complet métrique
Metrisches Vollprofil
Metric full profile

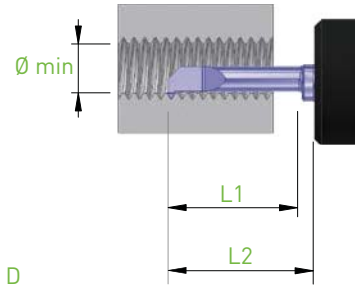
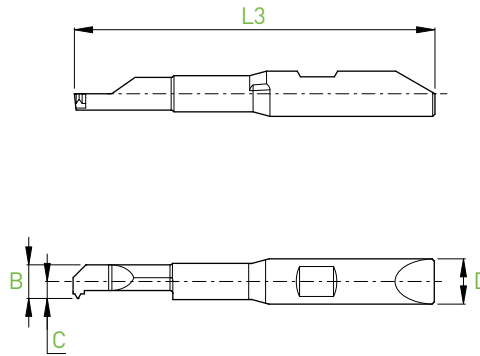
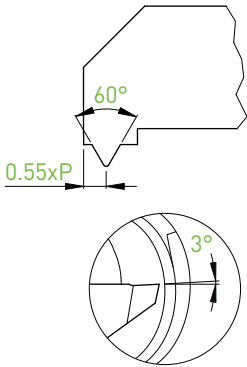

R

D h5	Holder	M (min)	Ø min	P (mm)	L1	L2 BH4... BHY4...	L2 BHS4... BHK4...	B	C	L3	Art. N°	ZTAF	ZN
4	BH4... BHS4...	M3x0.5	2.50	0.50	6.0	10	8.5	2.25	1.35	32	BF4R-2560-TM-0.50	■	■
	BHY4... BHK4...	M4x0.7	3.30	0.70	8.0	15	13.5	2.97	1.50	37	BF4R-3380-TM-0.70	■	■
D h5	Holder	M (min)	Ø min	P (mm)	L1	L2 BH6... BHY6...	L2 BHS6... BHK6...	B	C	L3	Art. N°	ZTAF	ZN
6	BH6... BHS6...	M5x0.8	4.20	0.80	10.0	20	18.5	3.78	2.10	47	BF6R-42100-TM-0.80	■	■
	BHY6... BHK6...	M6x1.0	5.00	1.00	12.0	20	18.5	4.50	2.20	47	BF6R-50120-TM-1.00	■	■

IN-LINE

- Gorge frontale extérieure
- Aussen axiales stechen
- External axial grooving



BB6...

FEG

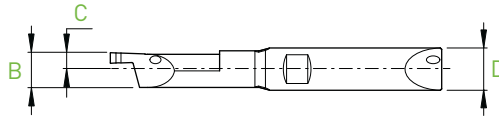
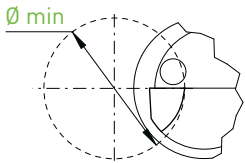
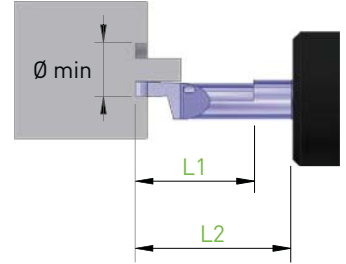
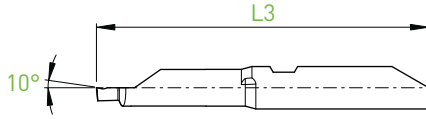
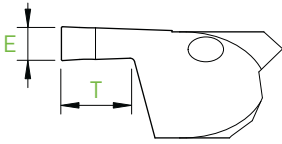

R

D h5	Holder	Ø min	L1	L2 BH6... BHY6...	L2 BHS6... BHK6...	T	B	C	E	L3	Art. N°	ZTAF	ZN
6	BH6... BHS6... BHY6... BHK6...	5.0	15.0	20	18.5	3.00	4.90	2.30	1.50	47	BB6R-50150-FEG150X	■	■

Gorge frontale intérieure

Innen axiales stechen

Internal axial grooving

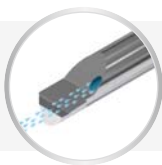

BB6...

FIG

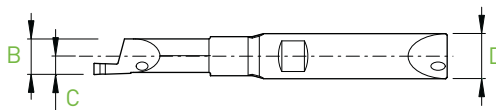
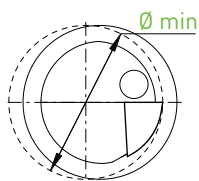
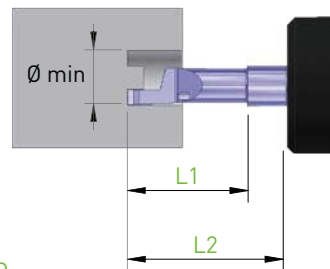
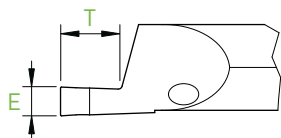

R

D h5	Holder	Ø min	L1	L2 BH6... BHY6...	L2 BHS6... BHK6...	T	B	C	E	L3	Art. N°	ZTAF	ZN
6	BH6... BHS6... BHY6... BHK6...	5.0	15.0	20	18.5	3.00	4.75	2.45	1.50	47	BB6R-50150-FIG150X	■	■

■ = disponible / verfügbar / available

□ = selon disponibilité du stock / jenach Lagerverfügbarkeit / depending the stock availability

IN-LINE

Ébauches avec arrosage
 Rohlinge mit Kühlung
 Blanks with coolant



BB4... / BB6...

BB_E

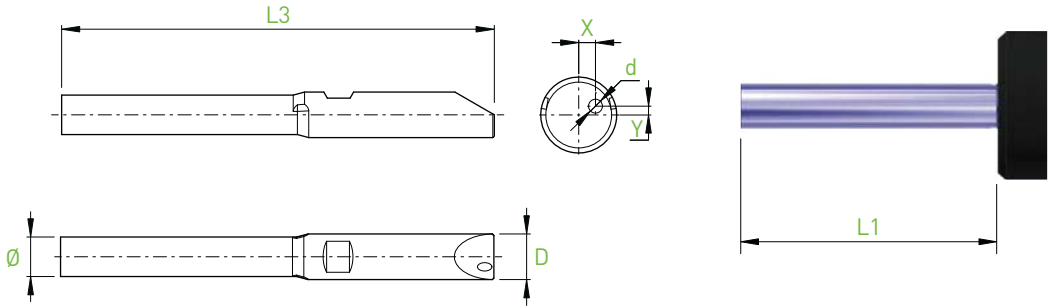

D_{h5}	Holder	L1 BH4... BHY4...	L1 BHS4... BHK4...	\emptyset	X	Y	d	L3	Art. N°	ZN
4	BH4... BHS4... BHY4... BHK4...	20.0	18.5	3.20	0.84	0.55	0.85	42	BB4R-E42	■
D_{h5}	Holder	L1 BH6... BHY6...	L1 BHS6... BHK6...	\emptyset	X	Y	d	L3	Art. N°	ZN
6	BH6... BHS6... BHY6... BHK6...	30.0	28.5	5.20	1.33	0.70	1.10	57	BB6R-E57	■

Ébauches

Rohlinge

Blanks



BF4... / BF6...

BF_E

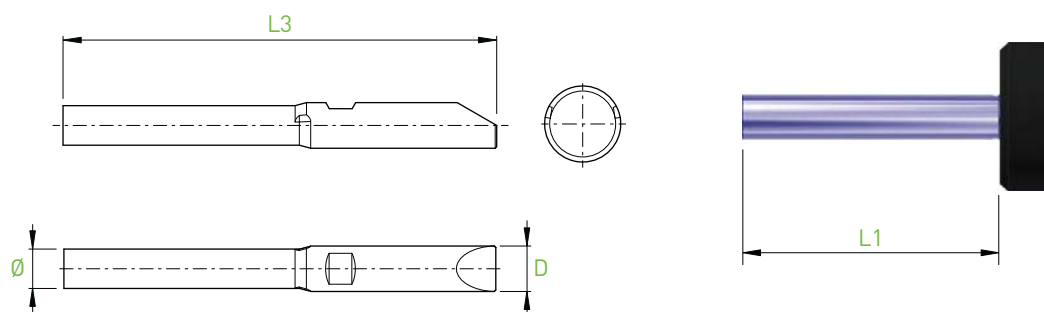

D_{h5}	Holder	L1 BH4... BHY4...	L1 BHS4... BHK4...	\emptyset	L3	Art. N°	ZN
4	BH4... BHS4... BHY4... BHK4...	20.0	18.5	3.20	42	BF4-E42	■
D_{h5}	Holder	L1 BH6... BHY6...	L1 BHS6... BHK6...	\emptyset	L3	Art. N°	ZN
6	BH6... BHS6... BHY6... BHK6...	30.0	28.5	5.20	57	BF6-E57	■

IN-LINE

Jauges d'alignement
Richtplatten
Adjusting tools

MASTER

BH4 / BH6

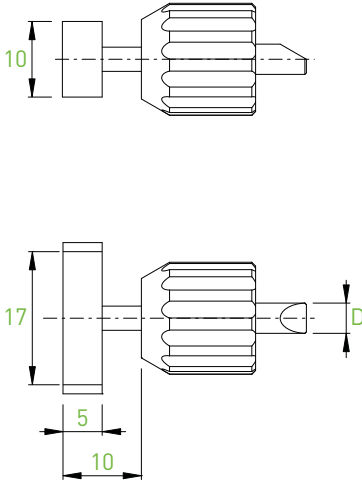

D h5	Art. N°	
4	BH4-MASTER	■
6	BH6-MASTER	■

Jauges d'alignement
Richtplatten
Adjusting tools

MASTER

BHSY...

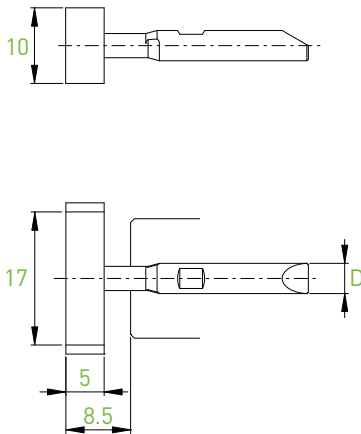

D h5	Art. N°	
4	BHSY4-MASTER	■
6	BHSY6-MASTER	■

Porte-outils avec arrosage pour contre-opération - Machines STAR
 Halter mit Kühlungssystem zur Gegenbearbeitung – STAR-Maschinen
 Backworking holders with through coolant – STAR-Machines

BH4 / BH6
 BHS4 / BHS6

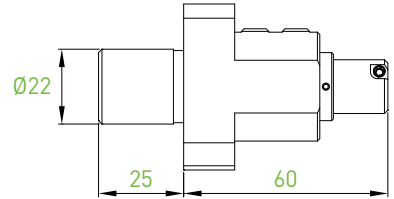
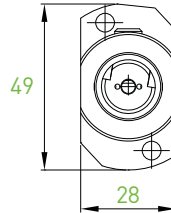

Art. N°

BWD1-2022-STAR-SRR



Art. N°

BHS4-D20-55-BWD1
 BHS6-D20-55-BWD1

Types of STAR machines

SR10J (T22+T24)
 SB16/20 Types C + D + E (T21-T24)
 SB20R Types E + G + N (T21-T24)
 SR20J / JN (T21-T24)
 SR20R / II / III (T21-T24)
 SR20R IV (T21-T24)
 SR32J/JN (T21-T24)
 SW12RII (T21-T24)
 SV20R (T21-T24)
 ECAS12/20 (T21-T24)
 SW20 (T21-T23)

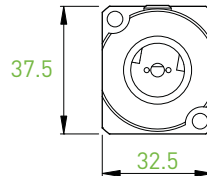

Art. N°

BWD1-2022-STAR-SW



Art. N°

BHS4-D20-55-BWD1
 BHS6-D20-55-BWD1

Types of STAR machines

SW12RII (T21-T28)
 SW20 (T21-T23 + T25-T27)
 SV20R (T21-T28)
 SR-20R IV (T21-T28)
 SB12/20R (T22-T24)
 SR38 (T21-T28)

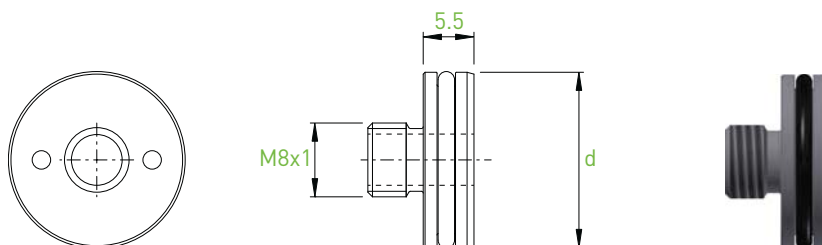

d	Art. N°	
19.05	JB-M8x1-D19.05	■
20	JB-M8x1-D20	■
22	JB-M8x1-D22	■
25	JB-M8x1-D25	■
25.4	JB-M8x1-D25.4	■

JET-LINE



NEW



DISCOVER JET-LINE IN A BRAND NEW BROCHURE !

Nouveautés présentées dans ce catalogue
 Neuheiten dieses Kataloges
 New products introduced in this catalogue



APPLITEC

Support de base Grundhalter Base holder			
Fabricant Hersteller Manufacturer	Machine Maschine Machine	Type Typ Type	Page Seite Page
Citizen	L12	ML12	11.07-11.15
	R04		
	R07		
	L20E	ML16	
Metafil	D10	ML12	11.19
Star	SB12RG	ML12	11.20-11.32
	SW12RII		
	SR20RIV	ML16	
	SR32J		
	SW20R		
Tornos	SWISS-NANO 7	ML12	11.37-11.44
	DT13		
	CT20		
	GT13		
	DT26	ML16	
	GT26		
	GT32		
Tsugami	B074	ML12	11.51
	B075		11.52
	P034		11.53-11.54

Porte-outils Halter Holders			
TOP-Line	> 11.60	TOP-Line	> 11.71
TURN-Line	> 11.61		
ISO-Line	> 11.62		
EVOCUT-Line	> 11.64	EVOCUT-Line	> 11.74
CUT-Line	> 11.65		
PRO-Line	> 11.66		
ECO-Line	> 11.66		

Système d'outils modulaires

Modulares Werkzeugsystem

Modular tooling system

Original system



MODU-Line system

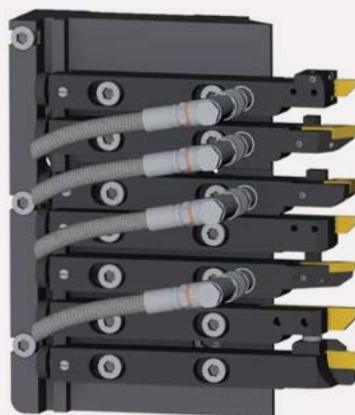

Système d'outils modulaires
pour tours automatiques

Modulares Werkzeugsystem
für Langdrehautomaten

Modular tooling system for
sliding headstock automatic lathes

Les avantages

Die Vorteile

The advantages

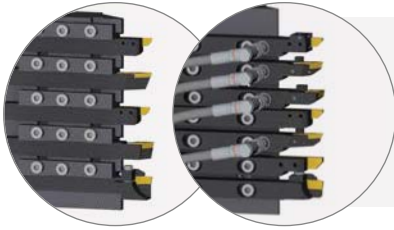

Plus d'outils disponibles
Höhere Werkzeuganzahl
More available tools

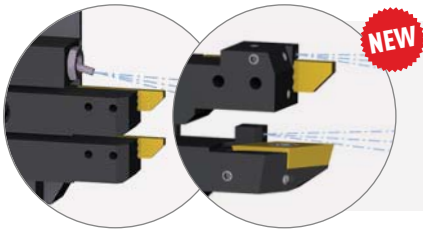

Système d'arrosage efficace
Effizientes Kühlmittelzufuhrsystem
Efficient coolant supply system

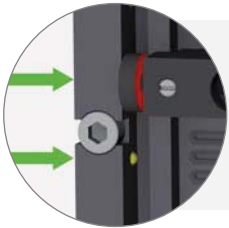

Repositionnement précis, poussée axiale automatique
Präzise Nachpositionierung, automatischer Axialschub
Precise repositioning, automatic axial thrust



Possibilité de pré réglage et de réglage de la longueur des outils
Voreinstellbar auf feste oder einstellbare Länge
Presetting on fixed or adjustable length

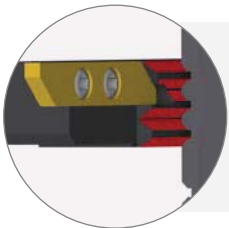

Système de fixation robuste et rigide
Robustes und starres Spannsystem
Strong and stable clamping system

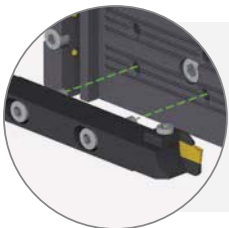

Changement d'outil simple et rapide
Einfacher und schneller Werkzeugwechsel
Easy and quick tool replacement

Adaptations disponibles pour les machines suivantes:
 Verfügbare Anpassungen für folgende Maschinen:
 Available adapters for the following machines:

**Citizen - Hanwha -
 Manurhin - Metafil - > 11.06
 Star - Tornos - Tsugami**

Porte-outils
 Halter
 Holders

INFO > 11.56

ML12



ML16



Right cut

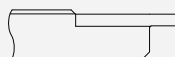

Cut off line



TOP-Line	11.60	TOP-Line	11.70
TURN-Line	11.61	TURN-Line	11.72
ISO-Line	11.62	ISO-Line	11.73
EVOCUT-Line	11.64	EVOCUT-Line	11.74
CUT-Line	11.65	CUT-Line	11.75
PRO-Line	11.66	PRO-Line	11.76
ECO-Line	11.66	ECO-Line	11.77
IN-Line	11.67		
TOOLING-Line	11.69		

Modules d'arrosage et de serrage
 Kühlmittelzufuhr- und Spannelemente
 Coolant and clamping supply unit

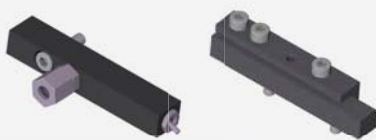

> 11.78

Banc de pré réglage
 Voreinstellgerät
 Presetting device



> 11.80

Pièces de rechange
 Ersatzteile
 Spare parts



> 11.82

Adaptations disponibles pour les machines suivantes

Verfügbare Anpassungen für folgende Maschinen

Available adapters for the following machines

Fabricant Hersteller Manufacturer	Machine Maschine Machine	Adaptations Anpassungen Adapters	Type Typ Type	Page Seite Page	
Citizen	C12/C16	ML12-CITIZEN-C16	ML12	11.06	
	L12	ML12-CITIZEN-L12		11.07	
	R04	ML12-CITIZEN-R04-QTF3101-3T		11.10	
		ML12-CITIZEN-R04-QTF5008-4T		11.08	
		ML12-CITIZEN-R04-QTF5108-4T			
		ML12-CITIZEN-R07-QTF4008-5T		11.11	
	R07	ML12-CITIZEN-R07-QTF4108-6T		ML16	11.12
		ML12-CITIZEN-R07-QTF4208-3T			
		ML12-CITIZEN-R07-QTF4608-4T			
		K16			ML16-CITIZEN-K16
L20	ML16-CITIZEN-L20	11.14			
L20E	ML16-CITIZEN-L20E	11.15			
Hanwha	XD20M	ML12-HANWHA-XD20M	ML12	11.16	
	SL12/16	ML16-HANWHA-SL12/16	ML16	11.17	
Manuhrin	KMX 426/526/626	ML16-KMX26-DUO	ML16	11.18	
		ML16-KMX26-JET			
Metafil	D10	ML12-D10-3T	ML12	11.19	
Star	SB12RG	ML12-STAR-SB-12RG	ML12	11.20	
	SR10-J	ML12-STAR-SR-10J		11.21	
	SW12RII	ML12-STAR-SW-12RII-2T		11.22	
		ML12-STAR-SW-12RII-8T			
	SA-12/SA16/SA16R	ML16-STAR-SA-16		11.23	
	SB16	ML16-STAR-SB-16		11.24	
	SB16/20RG	ML16-STAR-SB-16/20RG		11.25	
	SB20C/E	ML16-STAR-SB-20		11.26	
	SR20J	ML16-STAR-SR-20J		11.28	
	SR-16R/SR20R/SR20RII	ML16-STAR-SR-20R		11.27	
	SR20RIII	ML16-STAR-SR-20RIII		ML16	11.28
	SR20RIV	ML16-STAR-SR-20RIV-2T			11.29
		ML16-STAR-SR-20RIV-6T			
	SR32J	ML16-STAR-SR-32J		11.30	
	SV12/20	ML16-STAR-SV-12/20		11.31	
SW20R	ML16-STAR-SW-20R-2T	11.32			
	ML16-STAR-SW-20R-6T				
Tornos	DECO7/10 - EvoDECO 10	ML12-DECO10-DUO	ML12	11.33	
		ML12-DECO10-JET			
	SWISS-NANO /SWISS-NANO 7	ML12-SWISS-NANO-2T		11.36	
		ML12-SWISS-NANO-3T			
		ML12-SWISS-NANO-6T			11.34

Adaptations disponibles pour les machines suivantes

Verfügbare Anpassungen für folgende Maschinen

Available adapters for the following machines

Fabricant Hersteller Manufacturer	Machine Maschine Machine	Adaptations Anpassungen Adapters	Type Typ Type	Page Seite Page
Tornos	SWISS-NANO 7	ML12-SWISS-NANO-4T	ML12	11.37
	DT13	ML12-DT13-2020206-9T		11.38
	CT20	ML12-CT20-2020019-7T		11.39
	GT13	ML12-GT13-390224-5T		11.40
		ML12-GT13-390223-7T		
	DEC013- EvoDEC016	ML16-DEC013-DUO	ML16	11.46
		ML16-DEC013-JET		
	DEC020/26 - EvoDEC020/32	ML16-DEC020-DUO		11.47
		ML16-DEC020-JET		
	SIGMA20/32	ML16-S20-DUO	11.48	
		ML16-S20-JET		
	ST26	ML16-SWISS-ST26-DUO	ML16	11.49
		ML16-SWISS-ST26-JET		
	DT26	ML16-DT26-2020206-7T	11.50	
ML16-GT26-386210-5T				
GT26	ML16-GT26-386209-6T	11.42		
	ML16-GT32-389210-4T			
GT32	ML16-GT32-389209-5T	11.44		
Tsugami	B074	ML12-B074-1-6T	ML12	11.51
	B075	ML12-B075-1-8T		11.52
	PO34	ML12-PO34-1-5T		11.53
		ML12-PO34-1-7T		11.54
		ML12-PO34-2-4T		11.53
		ML12-PO34-2-10T		11.54

Citizen C12 / C16

+ 2 outils (max 8)
 + 2 Werkzeuge (max 8)
 + 2 tools (max 8)

ML12

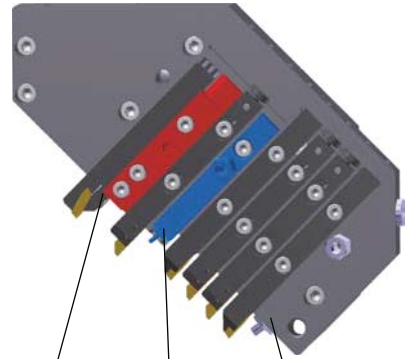
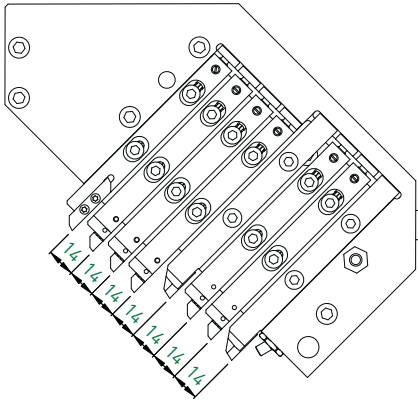

Outil \square 12 mm possible avec module de serrage
 Werkzeug \square 12 mm mit Spannelement möglich
 Tool \square 12mm possible with clamping unit

Module d'arrosage (prend la place d'un outil)
 Kühlmittelzufuhrelement (nimmt den Platz eines Werkzeuges)
 Coolant supply unit (takes the place of one tool)

Arrosage intégré
 Integrierter Kühlmittel
 Integrated coolant

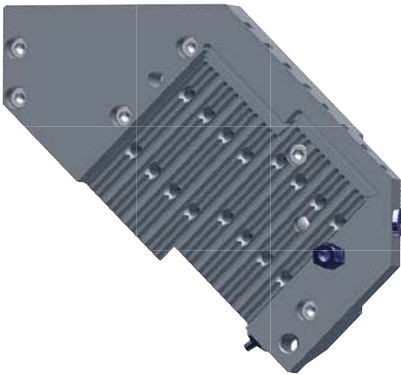

Support de base Grundhalter Base holder		Citizen C12 / C16		Accessoires Zubehöre Accessories	
Art. N°	Porte-outils Halter Holders	Pages Seiten Pages	Module de serrage Spannelement Clamping unit	Module d'arrosage Kühlmittelzufuhrelement Coolant supply unit	Page Seite Page
ML12-CITIZEN-C16	ML12	> 11.60	ML12-FIX-12/14	ML12-JET-5/16	11.78

Citizen L12

- + 2 outils (max 8)
- + 2 Werkzeuge (max 8)
- + 2 tools (max 8)

ML12

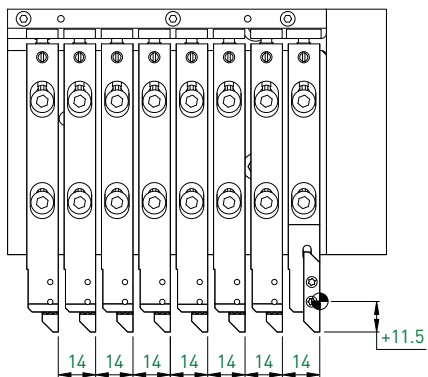

Support de base Grundhalter Base holder		Citizen L12		Accessoires Zubehöre Accessories	
Art. N°	Porte-outils Halter Holders	Pages Seiten Pages	Module de serrage Spannelement Clamping unit	Module d'arrosage Kühlmittelzufuhrelement Coolant supply unit	Page Seite Page
ML12-CITIZEN-L12	ML12	> 11.60	-	ML12-JET-5/16	11.78

Citizen R04

- + 1 outil (max 8)
- + 1 Werkzeug (max 8)
- + 1 tool (max 8)

ML12

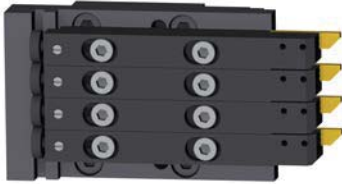
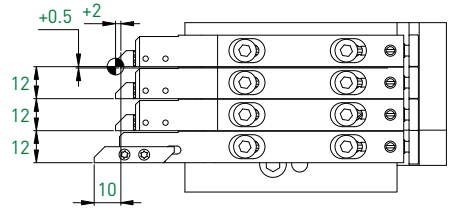
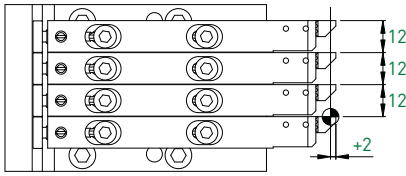

ML12-CITIZEN-R04-QTF5008-4T

ML12-CITIZEN-R04-QTF5108-4T

Support de base Grundhalter Base holder		Citizen R04		Accessoires Zubehöre Accessories		
Type Typ Type	Art. N°	Porte-outils Halter Holders	Pages Seiten Pages	Module de serrage Spannelement Clamping unit	Module d'arrosage Kühlmittelzufuhrelement Coolant supply unit	Page Seite Page
4T	ML12-CITIZEN-R04-QTF5008-4T ML12-CITIZEN-R04-QTF5108-4T	ML12	> 11.60	-	ML12-JET-5/16	11.78

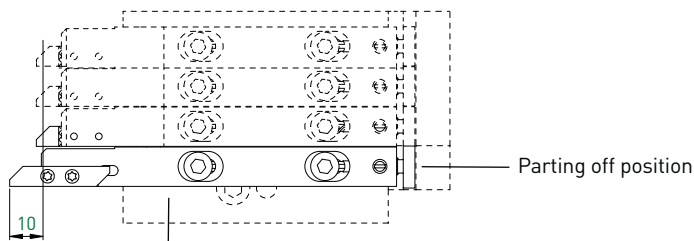

ML12-CITIZEN-R04-QTF5108-4T

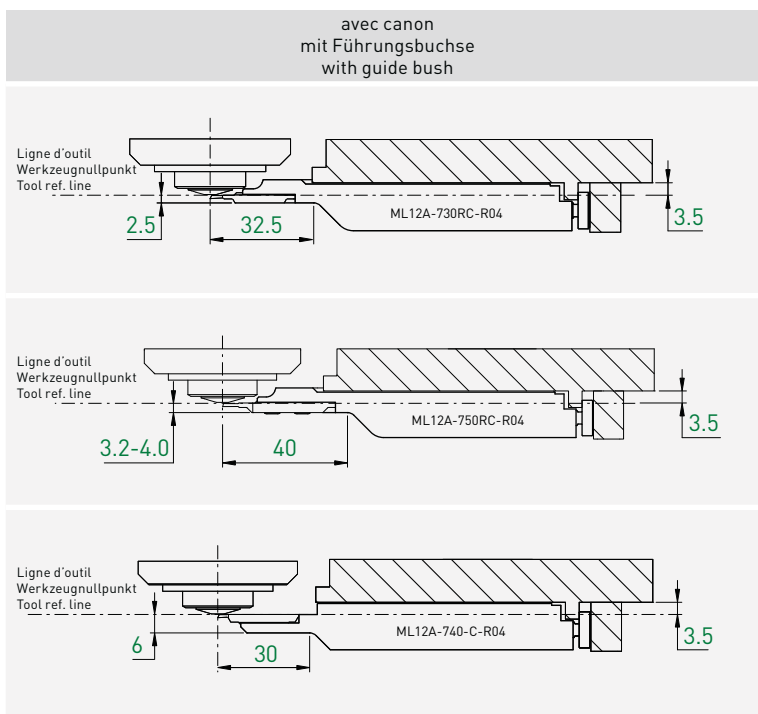

Type de machine Maschinen-Typ Type of machine	Porte-outils Halter Holders	Art. N°	Plaquettes Wendplatten Inserts	Pages Seiten Pages
Citizen R04	ML12	ML12A-730RC-R04	731R... / 731RSF	1.39-45 / 2.20
		ML12A-750RC-R04	751R... / 751RDSF	1.88-97 / 2.20
		ML12A-740-C-R04	741 / 741SF	1.32-38 / 2.12

Citizen R04

- + 3 outils (max 3)
- + 3 Werkzeuge (max 3)
- + 3 tools (max 3)

ML12

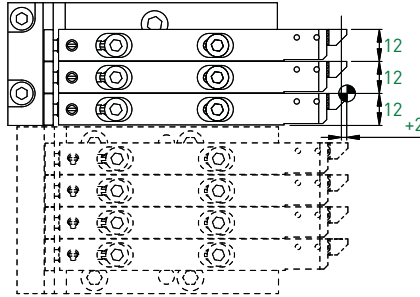

Support de base Grundhalter Base holder		Citizen R04		Accessoires Zubehöre Accessories	
Art. N°	Porte-outils Halter Holders	Pages Seiten Pages	Module de serrage Spannelement Clamping unit	Module d'arrosage Kühlmittelzufuhrelement Coolant supply unit	Page Seite Page
ML12-CITIZEN-R04-QTF3101-3T	ML12	> 11.60	-	ML12-JET-5/16	11.78

Citizen R07

- + 1 outil (max 11)
- + 1 Werkzeug (max 11)
- + 1 tool (max 11)

ML12

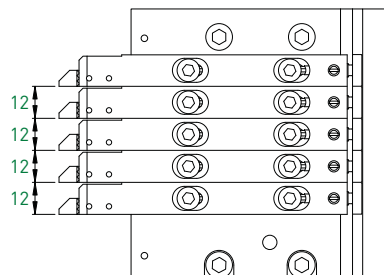
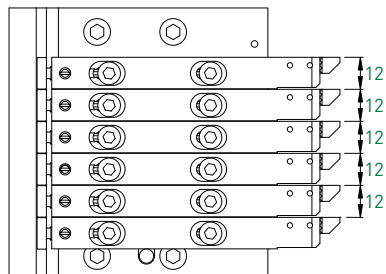

ML12-CITIZEN-R07-QTF4108-6T

ML12-CITIZEN-R07-QTF4008-5T

Support de base Grundhalter Base holder		Citizen R07		Accessoires Zubehöre Accessories		
Type Typ Type	Art. N°	Porte-outils Halter Holders	Pages Seiten Pages	Module de serrage Spannelement Clamping unit	Module d'arrosage Kühlmittelzufuhrelement Coolant supply unit	Page Seite Page
5T	ML12-CITIZEN-R07-QTF4008-5T	ML12	> 11.60	-	ML12-JET-5/16	11.78
6T	ML12-CITIZEN-R07-QTF4108-6T					

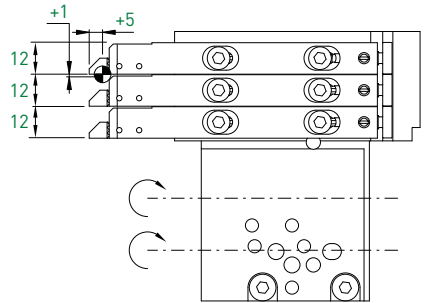
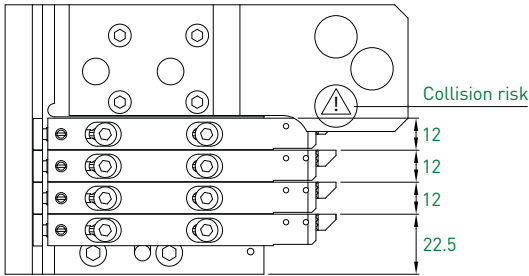

ML12-CITIZEN-R07-QTF4608-4T

ML12-CITIZEN-R07-QTF4208-3T

Support de base Grundhalter Base holder		Citizen R07		Accessoires Zubehöre Accessories		
Type Typ Type	Art. N°	Porte-outils Halter Holders	Pages Seiten Pages	Module de serrage Spannelement Clamping unit	Module d'arrosage Kühlmittelzufuhrelement Coolant supply unit	Page Seite Page
3T	ML12-CITIZEN-R07-QTF4208-3T	ML12	> 11.60	-	ML12-JET-5/16	11.78
4T	ML12-CITIZEN-R07-QTF4608-4T					

Citizen K12 / K16

- + 2 outils (max 8)
- + 2 Werkzeuge (max 8)
- + 2 tools (max 8)

ML16

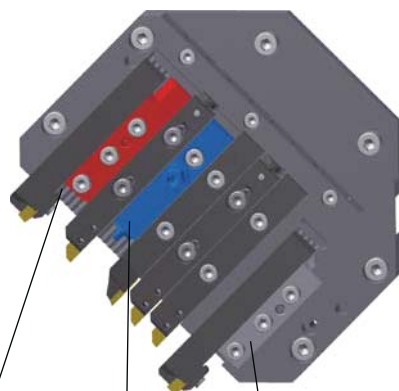
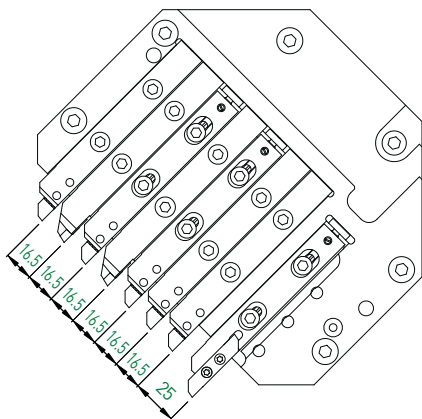

Outil \square 16 mm possible avec module de serrage
 Werkzeug \square 16 mm mit Spannelement möglich
 Tool \square 16 mm possible with clamping unit

Module d'arrosage (prend la place d'un outil)
 Kühlmittelzufuhrelement (nimmt den Platz eines Werkzeuges)
 Coolant supply unit (takes the place of one tool)

1 serrage ML16-FIX-16 pour outil \square 16 mm inclus
 1 Spannung ML16-FIX-16 für Werkzeug \square 16 mm inbegriffen
 1 clamping ML16-FIX-16 for tool \square 16 mm included

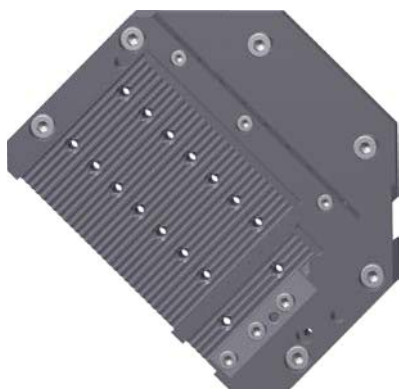

Support de base Grundhalter Base holder		Citizen K12 / K16		Accessoires Zubehöre Accessories	
Art. N°	Porte-outils Halter Holders	Pages Seiten Pages	Module de serrage Spannelement Clamping unit	Module d'arrosage Kühlmittelzufuhrelement Coolant supply unit	Page Seite Page
ML16-CITIZEN-K16	ML16	> 11.60	ML16-FIX-16/16.5	ML16-JET-7/16	11.78

Citizen L16 / L20

- + 1 outil (max 7)
- + 1 Werkzeug (max 7)
- + 1 tool (max 7)

ML16

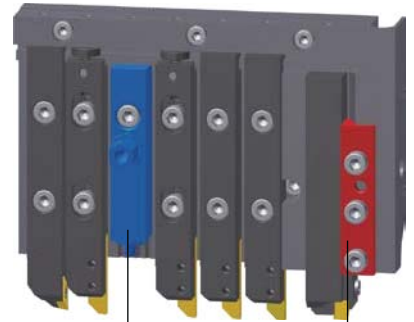
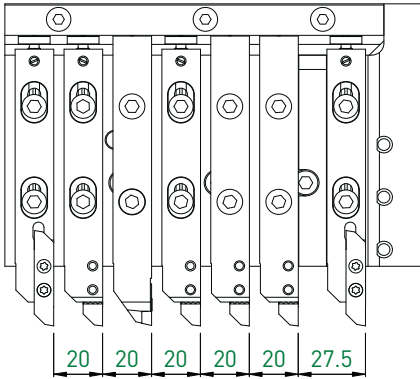

Module d'arrosage (prend la place d'un outil)
 Kühlmittelzufuhrelement (nimmt den Platz eines Werkzeuges)
 Coolant supply unit (takes the place of one tool)

- 1 serrage ML16-FIX-16 pour outil \varnothing 16 mm inclus
- 1 Spannung ML16-FIX-16 für Werkzeug \varnothing 16 mm inbegriffen
- 1 clamping ML16-FIX-16 for tool \varnothing 16 mm included



Support de base Grundhalter Base holder		Citizen L16 / L20		Accessoires Zubehöre Accessories	
Art. N°	Porte-outils Halter Holders	Pages Seiten Pages	Module de serrage Spannelement Clamping unit	Module d'arrosage Kühlmittelzufuhrelement Coolant supply unit	Page Seite Page
ML16-CITIZEN-L20	ML16	> 11.60	-	ML16-JET-7/16	11.78

Citizen L20E

- + 1 outil (max 6)
- + 1 Werkzeug (max 6)
- + 1 tool (max 6)

ML16

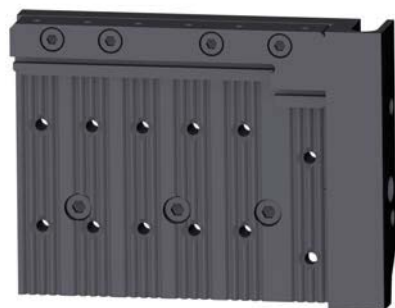
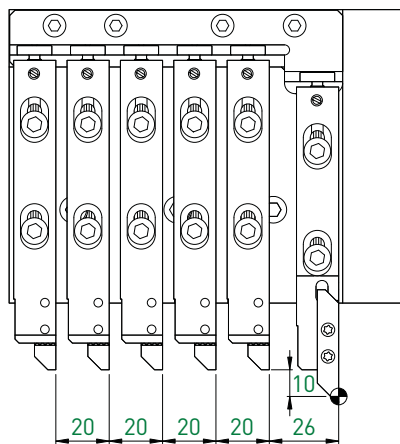

Support de base Grundhalter Base holder		Citizen L20E		Accessoires Zubehöre Accessories		
Art. N°	Porte-outils Halter Holders	Pages Seiten Pages	Module de serrage Spannelement Clamping unit	Module d'arrosage Kühlmittelzufuhrelement Coolant supply unit	Page Seite Page	
ML16-CITIZEN-L20E	ML16	> 11.60	-	ML16-JET-7/16	11.78	

Hanwha XD20M

- + 2 outils (max 7)
- + 2 Werkzeuge (max 7)
- + 2 tools (max 7)

ML12

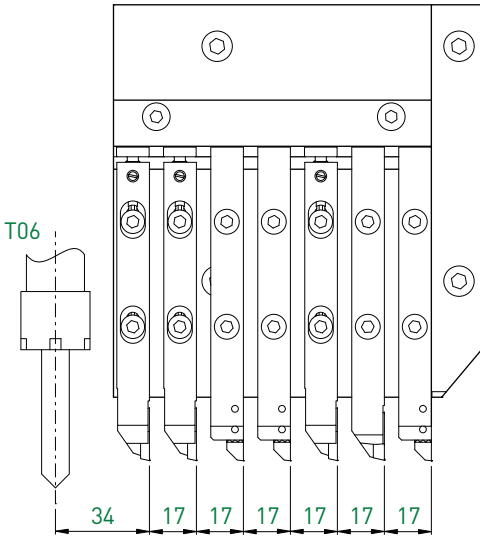

Support de base Grundhalter Base holder		Hanwha XD20M		Accessoires Zubehöre Accessories	
Art. N°	Porte-outils Halter Holders	Pages Seiten Pages	Module de serrage Spannelement Clamping unit	Module d'arrosage Kühlmittelzufuhrelement Coolant supply unit	Page Seite Page
ML12-HANWHA-XD20M	ML12	> 11.60	-	ML12-JET-5/16	11.78

Hanwha SL12 / 16

- + 1 outil (max 7)
- + 1 Werkzeug (max 7)
- + 1 tool (max 7)

ML16

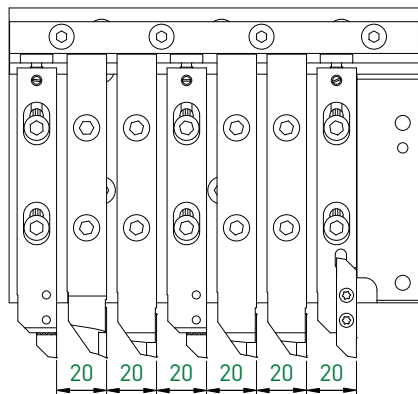

Support de base Grundhalter Base holder		Hanwha SL12 / 16		Accessoires Zubehöre Accessories	
Art. N°	Porte-outils Halter Holders	Pages Seiten Pages	Module de serrage Spannelement Clamping unit	Module d'arrosage Kühlmittelzufuhrelement Coolant supply unit	Page Seite Page
ML16-HANWHA-SL12/16	ML16	> 11.60	-	ML16-JET-7/16	11.78

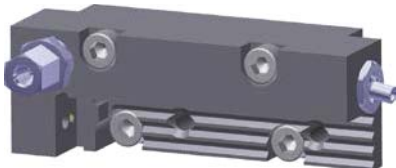
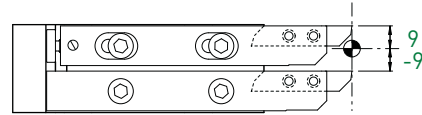
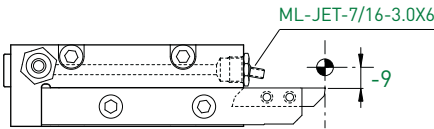
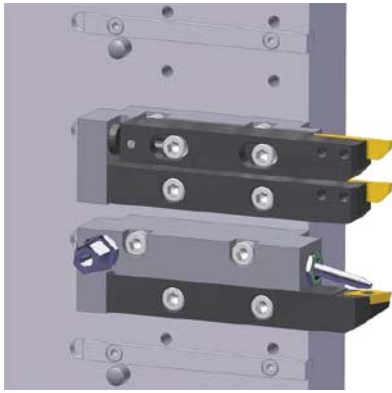

Jet



Duo

Support de base Grundhalter Base holder		Manurhin KMX 426/526/626 Swing 20-26 mm		Accessoires Zubehöre Accessories		
Type Typ Type	Art. N°	Porte-outils Halter Holders	Pages Seiten Pages	Module de serrage Spannelement Clamping unit	Module d'arrosage Kühlmittelezufuhrelement Coolant supply unit	Page Seite Page
Jet	ML16-KMX26-JET	ML16	> 11.60	-	ML-JET-7/16...	11.78
Duo	ML16-KMX26-DUO			-	ML16-JET-7/16	

	D3	+ 1 outil (max 3)	
	Metafil D10	+ 1 Werkzeug (max 3)	ML12
	D13	+ 1 tool (max 3)	

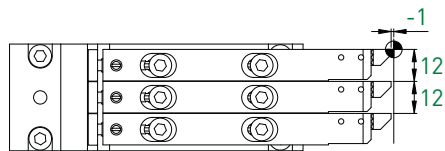

Support de base Grundhalter Base holder		Metafil D3 / D10 / D13		Accessoires Zubehöre Accessories	
Art. N°	Porte-outils Halter Holders	Pages Seiten Pages	Module de serrage Spannelement Clamping unit	Module d'arrosage Kühlmittelzufuhrelement Coolant supply unit	Page Seite Page
ML12-D10-3T	ML12	> 11.60	-	ML12-JET-5/16	11.78

Star SB-12RG

- + 2 outils (max 9)
- + 2 Werkzeuge (max 9)
- + 2 tools (max 9)

ML12

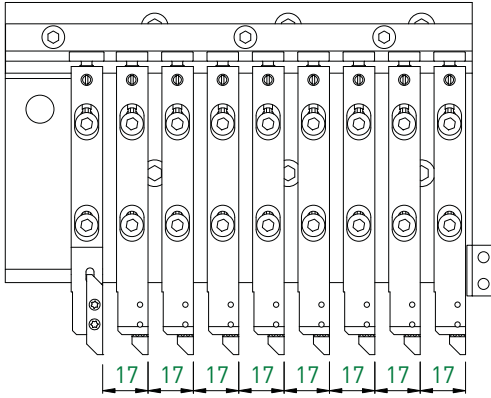

Support de base Grundhalter Base holder		Star SB-12RG		Accessoires Zubehöre Accessories	
Art. N°	Porte-outils Halter Holders	Pages Seiten Pages	Module de serrage Spannelement Clamping unit	Module d'arrosage Kühlmittelzufuhrelement Coolant supply unit	Page Seite Page
ML12-STAR-SB-12RG	ML12	> 11.60	-	ML12-JET-5/16	11.78

Star SR-10J

- + 2 outils (max 8)
- + 2 Werkzeuge (max 8)
- + 2 tools (max 8)

ML12

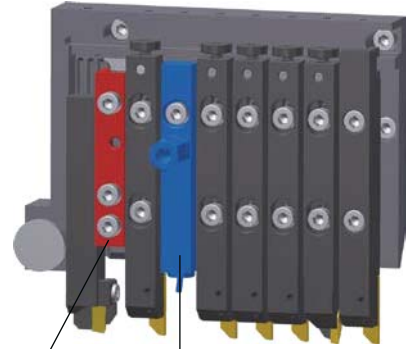
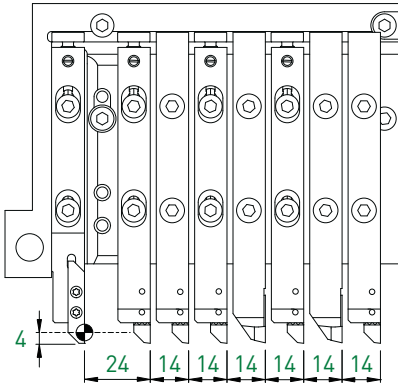

- 1 serrage ML12-FIX-12 pour outil \square 12 mm inclus
- 1 Spannung ML12-FIX-12 für Werkzeug \square 12 mm inbegriffen
- 1 clamping ML12-FIX-12 for tool \square 12 mm included

Module d'arrosage (prend la place d'un outil)
 Kühlmittelzufuhrelement (nimmt den Platz eines Werkzeuges)
 Coolant supply unit (takes the place of one tool)



Support de base Grundhalter Base holder		Accessoires Zubehöre Accessories			
Star SR-10J					
Art. N°	Porte-outils Halter Holders	Pages Seiten Pages	Module de serrage Spannelement Clamping unit	Module d'arrosage Kühlmittelzufuhrelement Coolant supply unit	Page Seite Page
ML12-STAR-SR-10J	ML12	> 11.60	ML12-FIX-12/14	ML12-JET-5/16	11.78

+ 2 outils (max 10)
 + 2 Werkzeuge (max 10)
 + 2 tools (max 10)

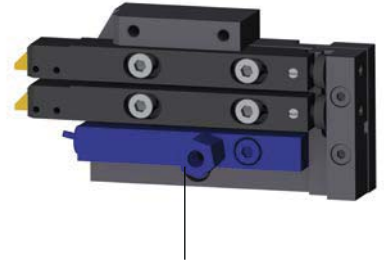
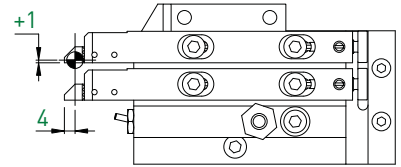
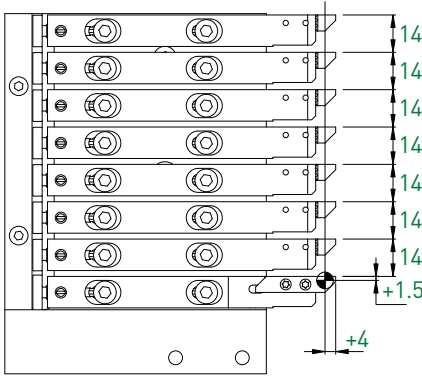

Position uniquement utilisable avec module d'arrosage, en option
 Position nur mit Kühlmittelzufuhrelement verwendbar, optional
 Position only with coolant supply unit usable, optional



ML12-STAR-SW-12RII-8T

ML12-STAR-SW-12RII-2T

Support de base Grundhalter Base holder		Star SW-12RII		Accessoires Zubehöre Accessories		
Type Typ Type	Art. N°	Porte-outils Halter Holders	Pages Seiten Pages	Module de serrage Spannelement Clamping unit	Module d'arrosage Kühlmittelzufuhrelement Coolant supply unit	Page Seite Page
2T	ML12-STAR-SW-12RII-2T	ML12	> 11.60	-	ML12-JET-5/16	11.78
8T	ML12-STAR-SW-12RII-8T					

- SA-12 + 2 outils (max 8)
- Star SA-16 + 2 Werkzeuge (max 8)
- SA-16R + 2 tools (max 8)

ML16

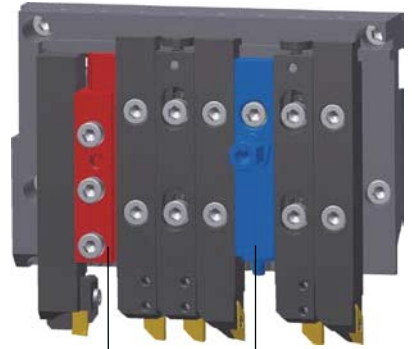
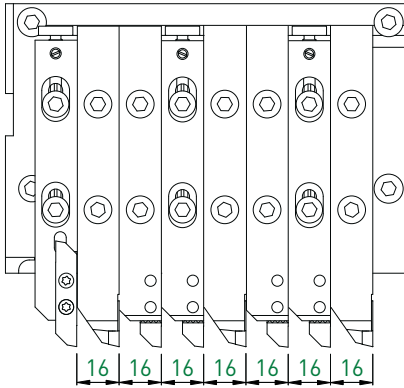

Outil 16 mm possible avec module de serrage
 Werkzeug 16 mm mit Spannelement möglich
 Tool 16 mm possible with clamping unit

Module d'arrosage (prend la place d'un outil)
 Kühlmittelzufuhrelement (nimmt den Platz eines Werkzeuges)
 Coolant supply unit (takes the place of one tool)



Support de base Grundhalter Base holder		Star SA-12/SA-16/SA-16R		Accessoires Zubehöre Accessories	
Art. N°	Porte-outils Halter Holders	Pages Seiten Pages	Module de serrage Spannelement Clamping unit	Module d'arrosage Kühlmittelzufuhrelement Coolant supply unit	Page Seite Page
ML16-STAR-SA-16	ML16	> 11.60	ML16-FIX-16/16	ML16-JET-7/16	11.78

Star SB-16

+ 3 outils (max 8)
 + 3 Werkzeuge (max 8)
 + 3 tools (max 8)

ML16

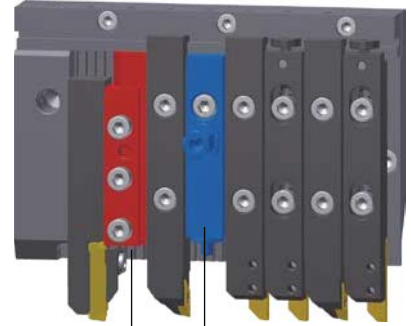
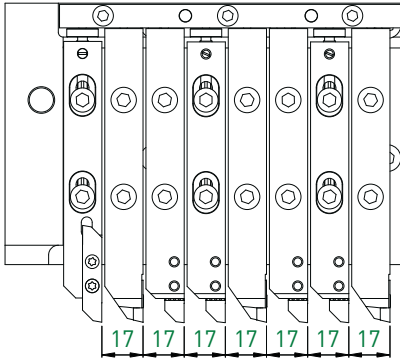

Outil \square 16 mm possible avec module de serrage
 Werkzeug \square 16 mm mit Spannelement möglich
 Tool \square 16 mm possible with clamping unit

Module d'arrosage (prend la place d'un outil)
 Kühlmittelzufuhrelement (nimmt den Platz eines Werkzeuges)
 Coolant supply unit (takes the place of one tool)



Support de base Grundhalter Base holder		Star SB-16		Accessoires Zubehöre Accessories	
Art. N°	Porte-outils Halter Holders	Pages Seiten Pages	Module de serrage Spannelement Clamping unit	Module d'arrosage Kühlmittelzufuhrelement Coolant supply unit	Page Seite Page
ML16-STAR-SB-16	ML16	> 11.60	ML16-FIX-16/17	ML16-JET-7/16	11.78

Star SB-16/20RG

- + 1 outil (max 7)
- + 1 Werkzeug (max 7)
- + 1 tool (max 7)

ML16

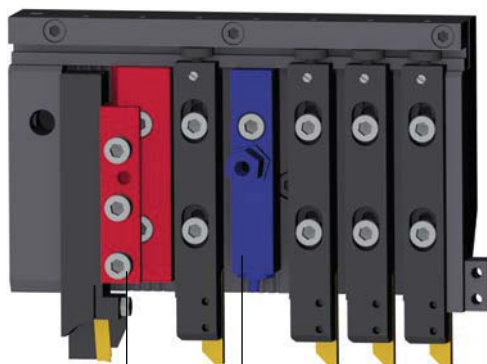
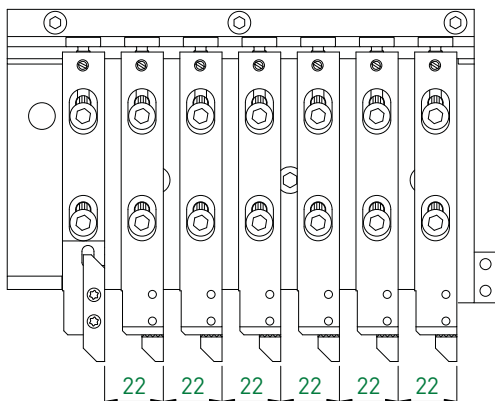

Outil 16 mm possible avec module de serrage
 Werkzeug 16 mm mit Spannelement möglich
 Tool 16 mm possible with clamping unit

Module d'arrosage (prend la place d'un outil)
 Kühlmittelzufuhrelement (nimmt den Platz eines Werkzeuges)
 Coolant supply unit (takes the place of one tool)



Support de base Grundhalter Base holder		Star SB-16/20RG		Accessoires Zubehöre Accessories	
Art. N°	Porte-outils Halter Holders	Pages Seiten Pages	Module de serrage Spannelement Clamping unit	Module d'arrosage Kühlmittelzufuhrelement Coolant supply unit	Page Seite Page
ML16-STAR-SB-16/20RG	ML16	> 11.60	ML16-FIX-16/22	ML16-JET-7/16	11.78

Star SB-20C/E

- + 1 outil (max 7)
- + 1 Werkzeug (max 7)
- + 1 tool (max 7)

ML16

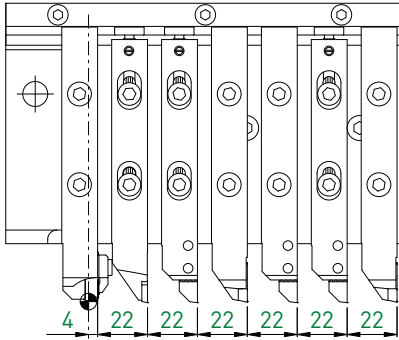

Outil \square 16 mm possible avec module de serrage
 Werkzeug \square 16 mm mit Spannelement möglich
 Tool \square 16 mm possible with clamping unit

Module d'arrosage (prend la place d'un outil)
 Kühlmittelzufuhrelement (nimmt den Platz eines Werkzeuges)
 Coolant supply unit (takes the place of one tool)



Support de base Grundhalter Base holder		Star SB-20C/E		Accessoires Zubehöre Accessories	
Art. N°	Porte-outils Halter Holders	Pages Seiten Pages	Module de serrage Spannelement Clamping unit	Module d'arrosage Kühlmittelzufuhrelement Coolant supply unit	Page Seite Page
ML16-STAR-SB20C/E	ML16	> 11.60	ML16-FIX-16/22	ML16-JET-7/16	11.78

- SR-16R** + 3 outils (max 9)
- Star SR-20R** + 3 Werkzeuge (max 9)
- SR-20RII** + 3 tools (max 9)

ML16

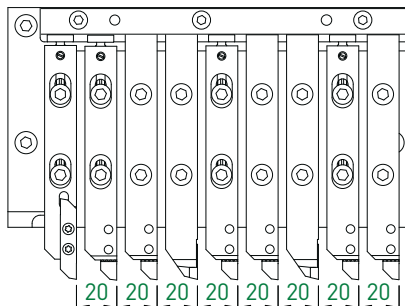

Outil ∇ 16 mm possible avec module de serrage
 Werkzeug ∇ 16 mm mit Spannelement möglich
 Tool ∇ 16 mm possible with clamping unit

Module d'arrosage (prend la place d'un outil)
 Kühlmittelzufuhrelement (nimmt den Platz eines Werkzeuges)
 Coolant supply unit (takes the place of one tool)



Support de base Grundhalter Base holder		Star SR-16R/SR-20R/SR-20RII		Accessoires Zubehöre Accessories	
Art. N°	Porte-outils Halter Holders	Pages Seiten Pages	Module de serrage Spannelement Clamping unit	Module d'arrosage Kühlmittelzufuhrelement Coolant supply unit	Page Seite Page
ML16-STAR-SR-20R	ML16	> 11.60	ML16-FIX-16/20	ML16-JET-7/16	11.78

Star **SR-20RIII**
SR-20J

+ 3 outils (max 9)
+ 3 Werkzeuge (max 9)
+ 3 tools (max 9)

ML16

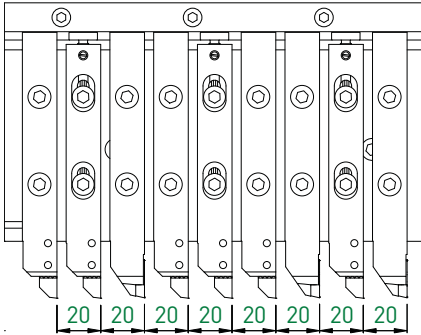

Outil 16 mm possible avec module de serrage
Werkzeug 16 mm mit Spannelement möglich
Tool 16 mm possible with clamping unit

Module d'arrosage (prend la place d'un outil)
Kühlmittelzufuhrelement (nimmt den Platz eines Werkzeuges)
Coolant supply unit (takes the place of one tool)



Support de base Grundhalter Base holder		Star SR-20RIII / SR-20J		Accessoires Zubehöre Accessories	
Art. N°	Porte-outils Halter Holders	Pages Seiten Pages	Module de serrage Spannelement Clamping unit	Module d'arrosage Kühlmittelzufuhrelement Coolant supply unit	Page Seite Page
ML16-STAR-SR-20RIII	ML16	> 11.60	ML16-FIX-16/20	ML16-JET-7/16	11.78
ML16-STAR-SR-20J	ML16				

Star SR-20RIV

- + 1 outil (max 8)
- + 1 Werkzeug (max 8)
- + 1 tool (max 8)

ML16

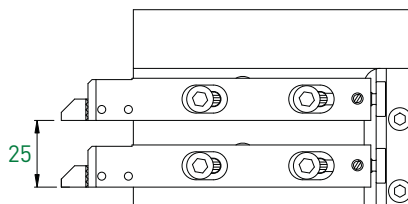
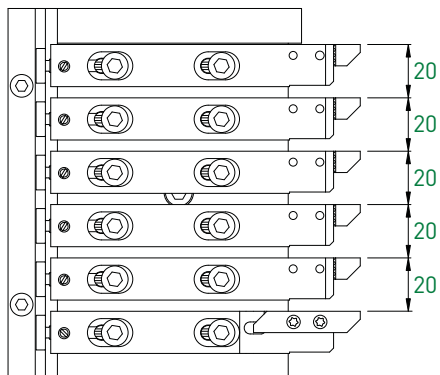

ML16-STAR-SR-20RIV-6T

ML16-STAR-SR-20RIV-2T

Support de base Grundhalter Base holder		Star SR-20RIV		Accessoires Zubehöre Accessories		
Type Typ Type	Art. N°	Porte-outils Halter Holders	Pages Seiten Pages	Module de serrage Spannelement Clamping unit	Module d'arrosage Kühlmitelzufuhrelement Coolant supply unit	Page Seite Page
2T	ML16-STAR-SR-20RIV-2T	ML16	> 11.60	-	ML16-JET-7/16	11.78
6T	ML16-STAR-SR-20RIV-6T					

MODU-LINE

Star SR-32J \varnothing max 32 mm
 + 1 outil (max 7)
 + 1 Werkzeug (max 7)
 + 1 tool (max 7)

\varnothing max 16 mm + 7 outils (max 13)
 + 7 Werkzeuge (max 13) **ML16**
 + 7 tools (max 13)

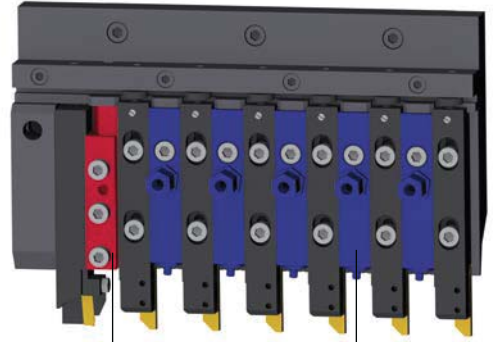
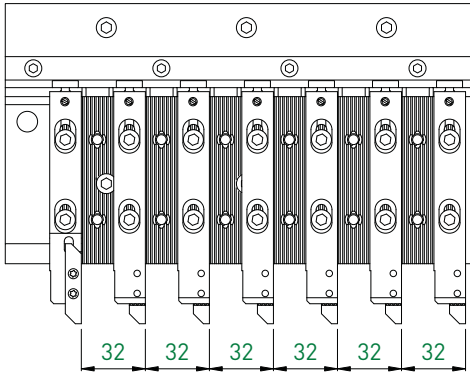

Outil \varnothing 16 mm possible avec module de serrage
 Werkzeug \varnothing 16 mm mit Spannelement möglich
 Tool \varnothing 16 mm possible with clamping unit

Module d'arrosage (prend la place d'un outil)
 Kühlmittelzufuhrelement (nimmt den Platz eines Werkzeuges)
 Coolant supply unit (takes the place of one tool)



Support de base Grundhalter Base holder		Star SR-32J		Accessoires Zubehöre Accessories	
Art. N°	Porte-outils Halter Holders	Pages Seiten Pages	Module de serrage Spannelement Clamping unit	Module d'arrosage Kühlmittelzufuhrelement Coolant supply unit	Page Seite Page
ML16-STAR-SR-32J	ML16	> 11.60	ML16-FIX-16/16	ML16-JET-7/16	11.78

Star SV-12 / 20

- + 2 outils (max 7)
- + 2 Werkzeuge (max 7)
- + 2 tools (max 7)

ML16

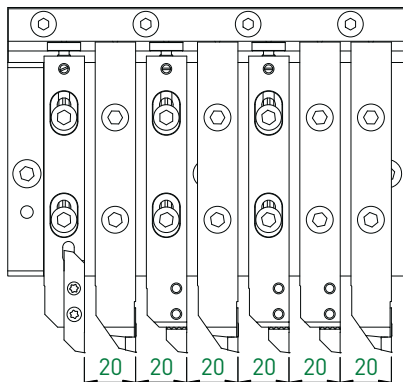

Outil ∇ 16 mm possible avec module de serrage
 Werkzeug ∇ 16 mm mit Spannelement möglich
 Tool ∇ 16 mm possible with clamping unit

Module d'arrosage (prend la place d'un outil)
 Kühlmittelzufuhrelement (nimmt den Platz eines Werkzeugs)
 Coolant supply unit (takes the place of one tool)



Support de base Grundhalter Base holder		Star SV-12 / 20		Accessoires Zubehöre Accessories	
Art. N°	Porte-outils Halter Holders	Pages Seiten Pages	Module de serrage Spannelement Clamping unit	Module d'arrosage Kühlmittelzufuhrelement Coolant supply unit	Page Seite Page
ML16-STAR-SV-12/20	ML16	> 11.60	ML16-FIX-16/20	ML16-JET-7/16	11.78

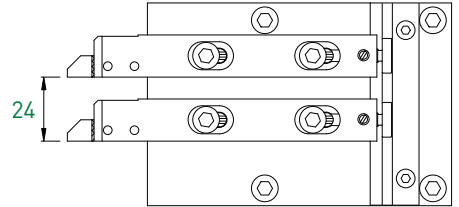
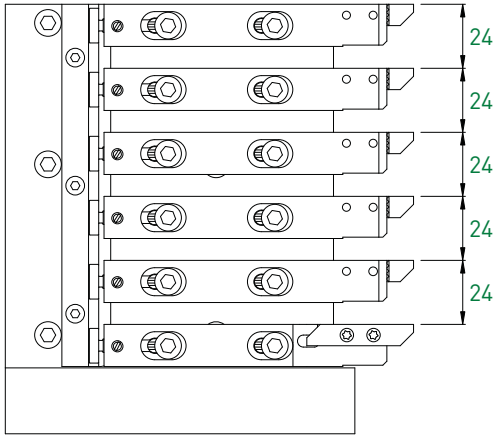

ML16-STAR-SW-20R-6T

ML16-STAR-SW-20R-2T

Support de base Grundhalter Base holder		Star SW-20R		Accessoires Zubehöre Accessories		
Type Typ Type	Art. N°	Porte-outils Halter Holders	Pages Seiten Pages	Module de serrage Spannelement Clamping unit	Module d'arrosage Kühlmittelezufuhrelement Coolant supply unit	Page Seite Page
2T	ML16-STAR-SW-20R-2T	ML16	> 11.60	-	ML16-JET-7/16	11.78
6T	ML16-STAR-SW-20R-6T			ML16-FIX-16/24		

Jet

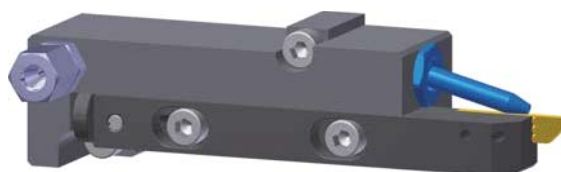

Duo

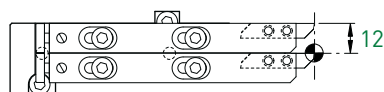
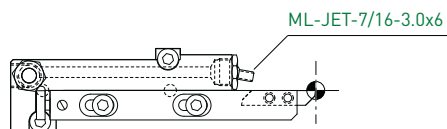

Jet

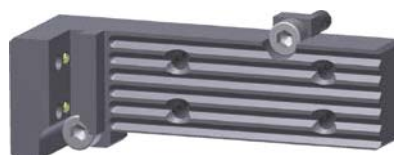

Duo

Support de base Grundhalter Base holder		Tornos DECO 7 / 10 EvoDECO 10		Accessoires Zubehöre Accessories		
Type Typ Type	Art. N°	Porte-outils Halter Holders	Pages Seiten Pages	Module de serrage Spannelement Clamping unit	Module d'arrosage Kühlmittelezufuhrelement Coolant supply unit	Page Seite Page
Jet	ML12-DECO10-JET	ML12	> 11.60	-	ML-JET-7/16...	11.79
Duo	ML12-DECO10-DUO				ML12-JET-5/16	11.78

Tornos **SwissNano**
SwissNano 7

+ 2 outils (max 6)
+ 2 Werkzeuge (max 6)
+ 2 tools (max 6)

ML12

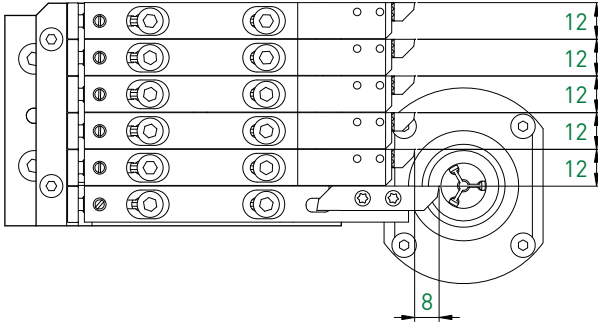

6T



6T

Support de base Grundhalter Base holder		Tornos SwissNano SwissNano 7		Accessoires Zubehöre Accessories		
Type Typ Type	Art. N°	Porte-outils Halter Holders	Pages Seiten Pages	Module de serrage Spannelement Clamping unit	Module d'arrosage Kühlmittelezufuhrelement Coolant supply unit	Page Seite Page
6T	ML12-SWISS-NANO-6T	ML12	> 11.60	-	ML12-JET-5/16	11.78

Tornos **SwissNano**
SwissNano 7

ML12

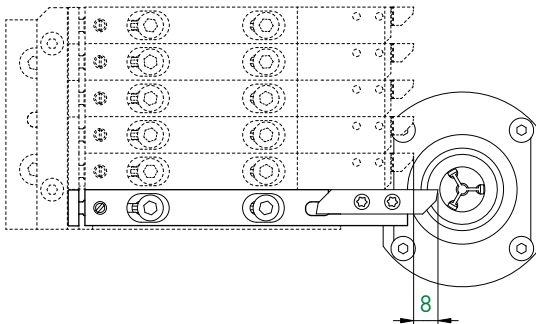

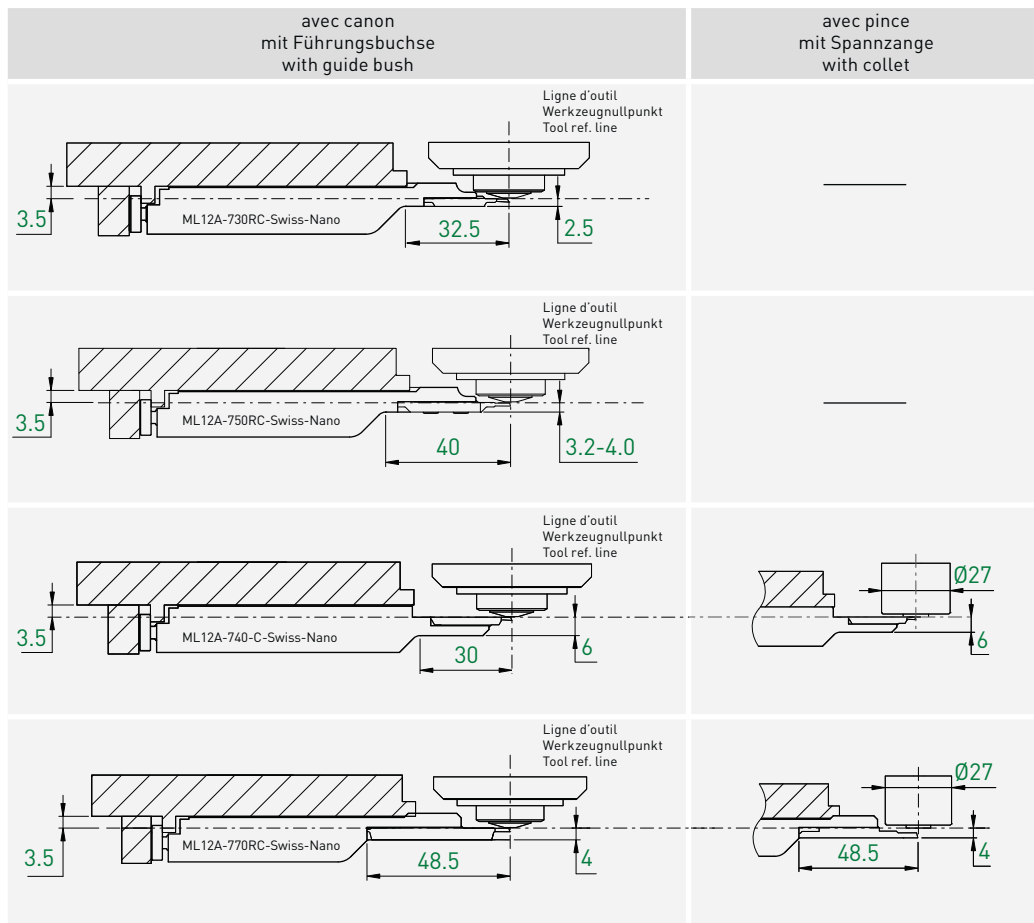

Type de machine Maschinen-Typ Type of machine	Porte-outils Halter Holders	Art. N°	Plaquettes Wendepplatten Inserts	Pages Seiten Pages
SwissNano	ML12	ML12A-730RC-SWISS-NANO	731R... / 731RSF	1.39-45 / 2.20
		ML12A-750RC-SWISS-NANO	751R... / 751RDSF	1.88-97 / 2.20
		ML12A-740-C-SWISS-NANO	741... / 741SF	1.32-38 / 2.12
		ML12A-770RC-SWISS-NANO	771R...	1.137-140

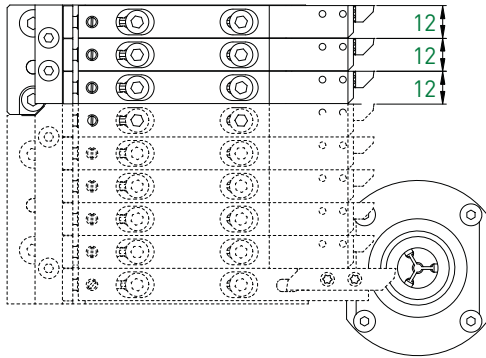
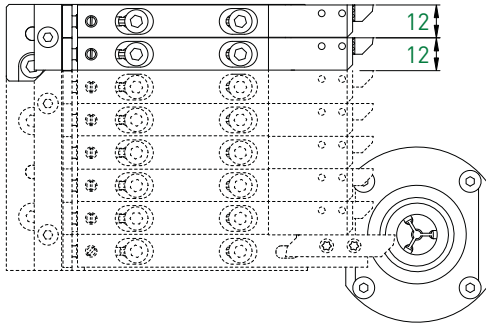

Support de base Grundhalter Base holder		Tornos SwissNano SwissNano 7		Accessoires Zubehöre Accessories		
Type Typ Type	Art. N°	Porte-outils Halter Holders	Pages Seiten Pages	Module de serrage Spannelement Clamping unit	Module d'arrosage Kühlmitelzufuhrelement Coolant supply unit	Page Seite Page
2T	ML12-SWISS-NANO-2T	ML12	> 11.60	-	ML12-JET-5/16	11.78
3T	ML12-SWISS-NANO-3T					

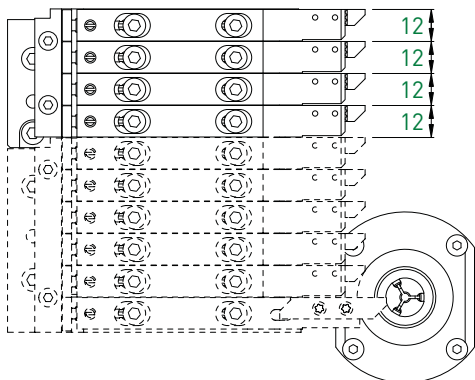

Support de base Grundhalter Base holder		Tornos SwissNano 7		Accessoires Zubehöre Accessories		
Type Typ Type	Art. N°	Porte-outils Halter Holders	Pages Seiten Pages	Module de serrage Spannelement Clamping unit	Module d'arrosage Kühlmittelfuhrlement Coolant supply unit	Page Seite Page
4T	ML12-SWISS-NANO-7-4T	ML12	> 11.60	-	ML12-JET-5/16	11.78

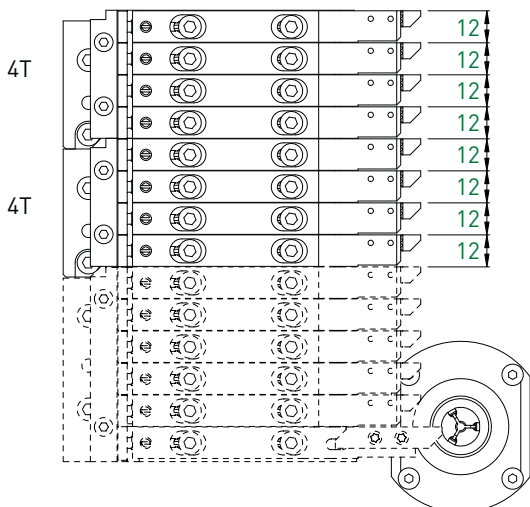

Possibilité de coupler 2 modules 4T
 2 Module 4T können gekoppelt werden
 Possibility to couple 2 modules 4T

Tornos DT 13

+ 3 outils (max 9)
 + 3 Werkzeuge (max 9)
 + 3 tools (max 9)

ML12

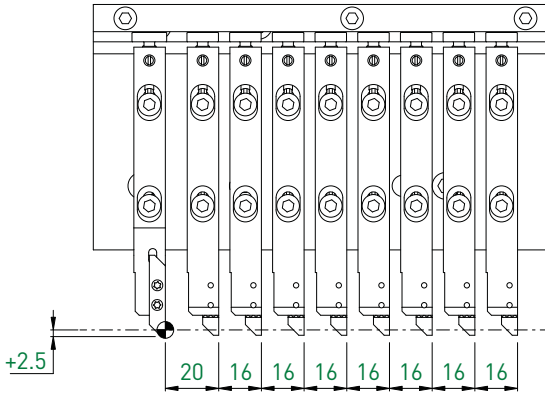

Support de base Grundhalter Base holder		Tornos DT 13		Accessoires Zubehöre Accessories		
Type Typ Type	Art. N°	Porte-outils Halter Holders	Pages Seiten Pages	Module de serrage Spannelement Clamping unit	Module d'arrosage Kühlmitelzufuhrelement Coolant supply unit	Page Seite Page
9T	ML12-DT13-2020206-9T	ML12	> 11.60	-	ML12-JET-5/16	11.78

Tornos CT 20

- + 1 outil (max 7)
- + 1 Werkzeug (max 7)
- + 1 tool (max 7)

ML12

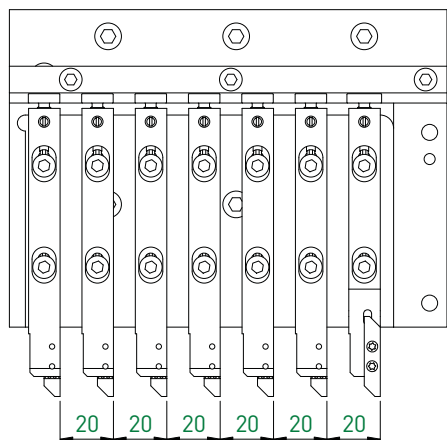

Support de base Grundhalter Base holder		Tornos CT 20		Accessoires Zubehöre Accessories		
Type Typ Type	Art. N°	Porte-outils Halter Holders	Pages Seiten Pages	Module de serrage Spannelement Clamping unit	Module d'arrosage Kühlmitelzufuhrelement Coolant supply unit	Page Seite Page
7T	ML12-CT20-2020019-7T	ML12	> 11.60	-	ML12-JET-5/16	11.78

Tornos GT 13

- + 5 outils (max 12)
- + 5 Werkzeuge (max 12)
- + 5 tools (max 12)

ML12

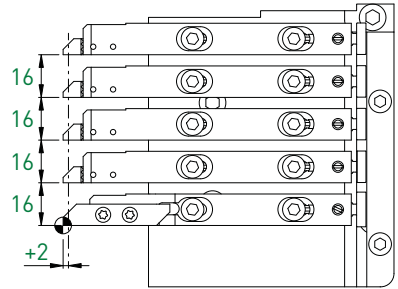
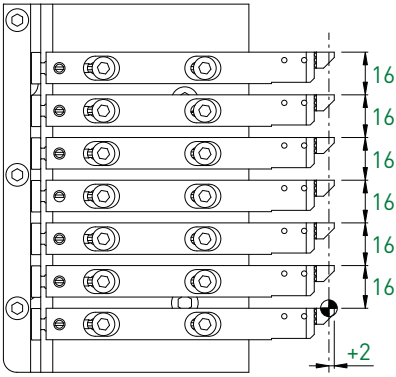



ML12-GT13-390223-7T



ML12-GT13-390224-5T

Support de base Grundhalter Base holder		Tornos GT 13		Accessoires Zubehöre Accessories		
Type Typ Type	Art. N°	Porte-outils Halter Holders	Pages Seiten Pages	Module de serrage Spannelement Clamping unit	Module d'arrosage Kühlmittelzufuhrelement Coolant supply unit	Page Seite Page
5T	ML12-GT13-390224-5T	ML12	> 11.60	-	ML12-JET-5/16	11.78
7T	ML12-GT13-390223-7T					

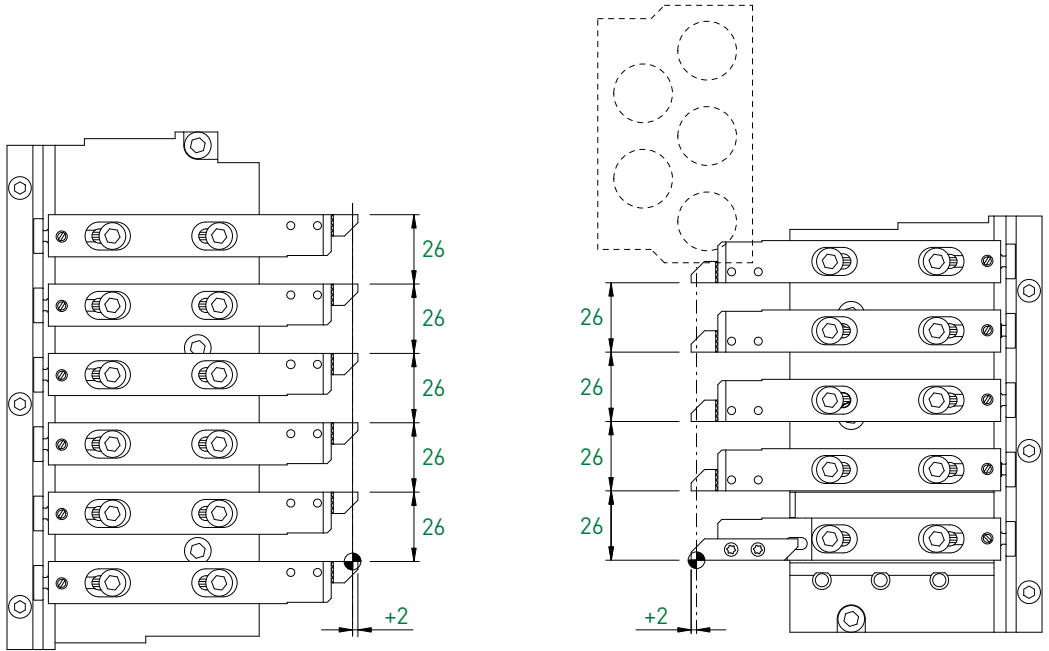

1 serrage ML16-FIX-16 pour outil \square 16 mm inclus
 1 Spannung ML16-FIX-16 für Werkzeug \square 16 mm inbegriffen
 1 clamping ML16-FIX-16 for tool \square 16 mm included



ML16-GT26-386209-6T



ML16-GT26-386210-5T

Support de base Grundhalter Base holder		Tornos GT 26		Accessoires Zubehöre Accessories		
Type Typ Type	Art. N°	Porte-outils Halter Holders	Pages Seiten Pages	Module de serrage Spannelement Clamping unit	Module d'arrosage Kühlmittelezufuhrelement Coolant supply unit	Page Seite Page
5T	ML16-GT26-386210-5T	ML16	> 11.60	-	ML16-JET-7/16	11.78
6T	ML16-GT26-386209-6T					

Tornos GT 32

+ 9 outils
 max + 9 Werkzeuge
 + 9 tools

ML16

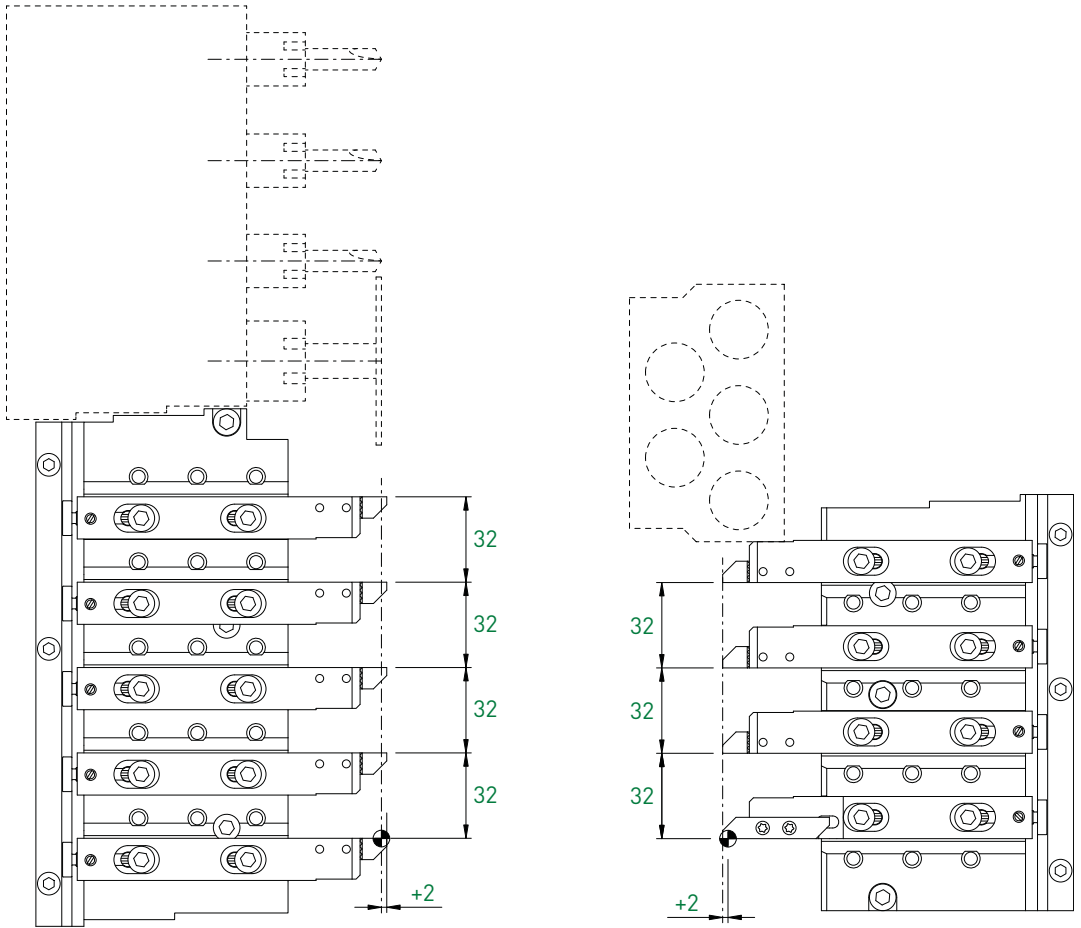

Holder ML16

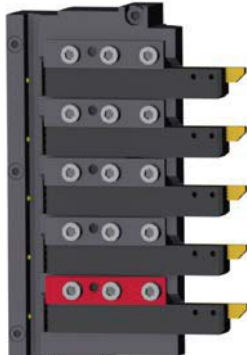

Holder □16



Holder ML16



Holder □16



ML16-GT32-386209-5T



ML16-GT32-386210-4T

Support de base Grundhalter Base holder		Tornos GT 32		Accessoires Zubehöre Accessories			
Type Typ Type	Art. N°	Porte-outils Halter Holders	Pages Seiten Pages	Module de serrage Spannelement Clamping unit		Module d'arrosage Kühlmittelzufuhrelement Coolant supply unit	
4T	ML16-GT32-386210-4T	ML16	> 11.60	1x inclus 1x inbegriffen 1x included		Option ML16-FIX-16	ML16-JET-7/16
5T	ML16-GT32-386209-5T			11.78			

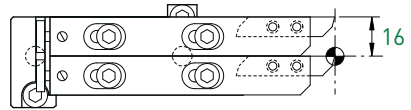
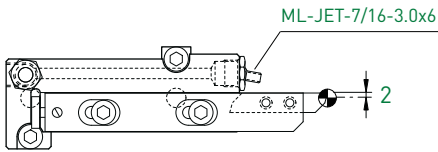

Jet



Duo

Support de base Grundhalter Base holder		Tornos DECO 13 / EvoDECO 16		Accessoires Zubehöre Accessories		
Type Typ Type	Art. N°	Porte-outils Halter Holders	Pages Seiten Pages	Module de serrage Spannelement Clamping unit	Module d'arrosage Kühlmittelzufuhrelement Coolant supply unit	Page Seite Page
Jet	ML16-DECO13-JET	ML16	> 11.60	-	ML-JET-7/16...	11.79
Duo	ML16-DECO13-DUO				ML16-JET-7/16	11.78



Jet



Duo

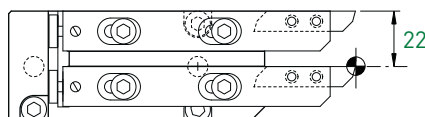
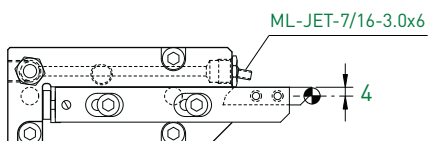

Jet



Duo

Support de base Grundhalter Base holder		Tornos DECO 20 / 26 EvoDECO 20 / 32		Accessoires Zubehöre Accessories		
Type Typ Type	Art. N°	Porte-outils Halter Holders	Pages Seiten Pages	Module de serrage Spannelement Clamping unit	Module d'arrosage Kühlmittelzufuhrelement Coolant supply unit	Page Seite Page
Jet	ML16-DECO20-JET	ML16	> 11.60	-	ML-JET-7/16...	11.79
Duo	ML16-DECO20-DUO				ML16-JET-7/16	11.78



Jet



Duo

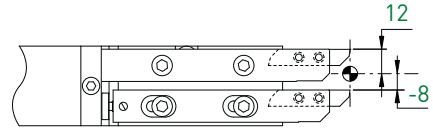
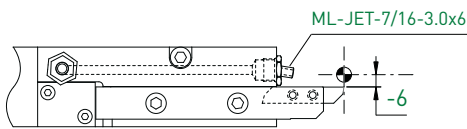

Jet



Duo

Support de base Grundhalter Base holder		Tornos SIGMA 20 / 32		Accessoires Zubehöre Accessories		
Type Typ Type	Art. N°	Porte-outils Halter Holders	Pages Seiten Pages	Module de serrage Spannelement Clamping unit	Module d'arrosage Kühlmittelzufuhrelement Coolant supply unit	Page Seite Page
Jet	ML16-S20-JET	ML16	> 11.60	-	ML-JET-7/16...	11.79
Duo	ML16-S20-DUO				ML16-JET-7/16	11.78

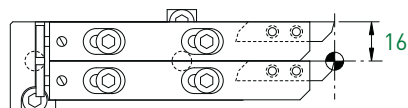
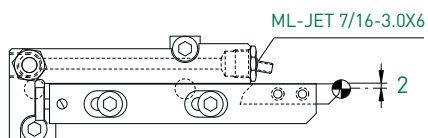

Jet



Duo

Support de base Grundhalter Base holder		Tornos Swiss ST 26		Accessoires Zubehöre Accessories		
Type Typ Type	Art. N°	Porte-outils Halter Holders	Pages Seiten Pages	Module de serrage Spannelement Clamping unit	Module d'arrosage Kühlmittelzufuhrelement Coolant supply unit	Page Seite Page
Jet	ML16-SWISS-ST26-JET	ML16	> 11.60	-	ML-JET-7/16...	11.79
Duo	ML16-SWISS-ST26-DUO				ML16-JET-7/16	11.78

Tornos DT 26

- + 1 outil (max 7)
- + 1 Werkzeug (max 7)
- + 1 tool (max 7)

ML16

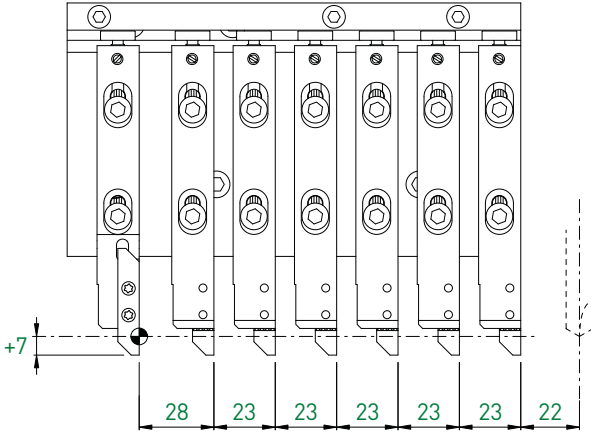

Support de base Grundhalter Base holder		Tornos DT 26		Accessoires Zubehöre Accessories		
Type Typ Type	Art. N°	Porte-outils Halter Holders	Pages Seiten Pages	Module de serrage Spannelement Clamping unit	Module d'arrosage Kühlmitelzufuhrelement Coolant supply unit	Page Seite Page
7T	ML16-DT26-2020206-7T	ML16	> 11.60	-	ML16-JET-7/16	11.78

Tsugami B074

- + 3 outils (max 6)
- + 3 Werkzeuge (max 6)
- + 3 tools (max 6)

ML12

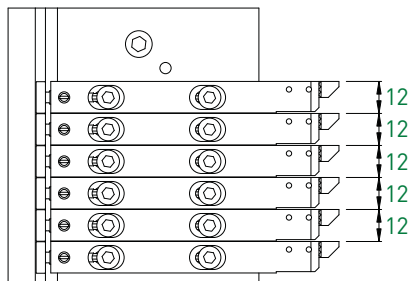

Support de base Grundhalter Base holder		Tsugami B074		Accessoires Zubehöre Accessories		
Type Typ Type	Art. N°	Porte-outils Halter Holders	Pages Seiten Pages	Module de serrage Spannelement Clamping unit	Module d'arrosage Kühlmittelzufuhrelement Coolant supply unit	Page Seite Page
6T	ML12-B074-1-6T	ML12	> 11.60	-	ML12-JET-5/16	11.78

Tsugami B075

- + 5 outils (max 8)
- + 5 Werkzeuge (max 8)
- + 5 tools (max 8)

ML12

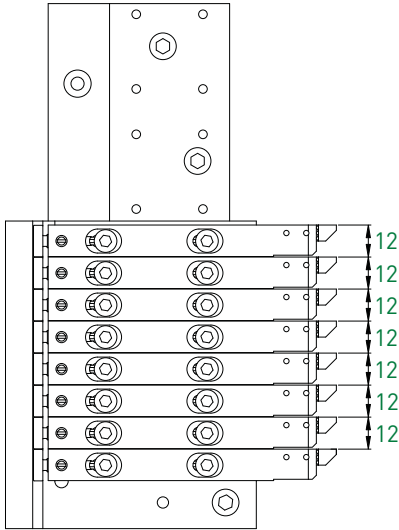

Support de base Grundhalter Base holder		Tsugami B075		Accessoires Zubehöre Accessories		
Type Typ Type	Art. N°	Porte-outils Halter Holders	Pages Seiten Pages	Module de serrage Spannelement Clamping unit	Module d'arrosage Kühlmitelzufuhrelement Coolant supply unit	Page Seite Page
8T	ML12-B075-1-8T	ML12	> 11.60	-	ML12-JET-5/16	11.78

Tsugami P034

- + 3 outils (max 9)
- + 3 Werkzeuge (max 9)
- + 3 tools (max 9)

ML12

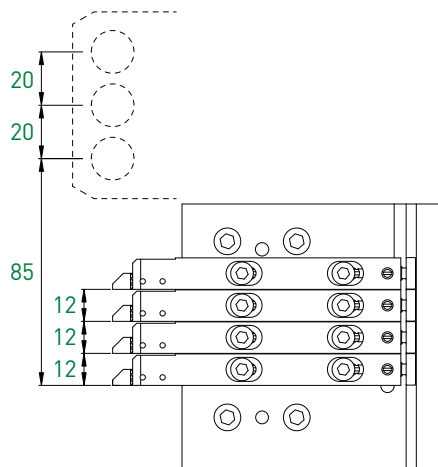
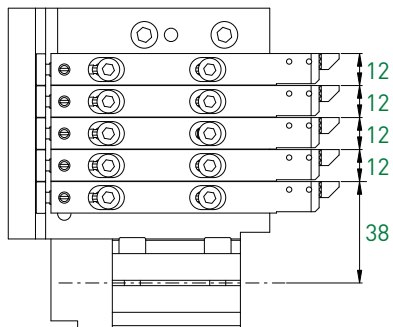

ML12-P034-1-5T

ML12-P034-2-4T

Support de base Grundhalter Base holder		Tsugami P034		Accessoires Zubehöre Accessories		
Type Typ Type	Art. N°	Porte-outils Halter Holders	Pages Seiten Pages	Module de serrage Spannelement Clamping unit	Module d'arrosage Kühlmittelzufuhrelement Coolant supply unit	Page Seite Page
4T	ML12-P034-2-4T	ML12	> 11.60	-	ML12-JET-5/16	11.78
5T	ML12-P034-1-5T					

Tsugami P034

max + 17 outils
+ 17 Werkzeuge
+ 17 tools

ML12

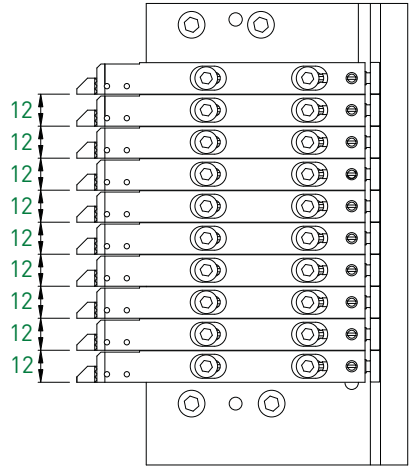
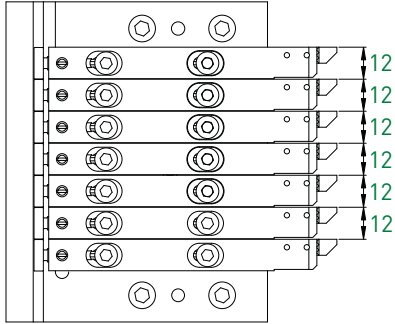

ML12-P034-1-7T

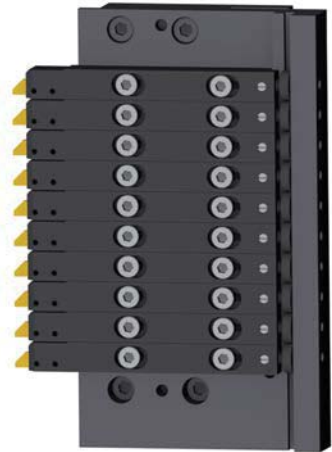

ML12-P034-2-10T



ML12-P034-1-7T



ML12-P034-2-10T

Support de base Grundhalter Base holder		Tsugami P034		Accessoires Zubehöre Accessories		
Type Typ Type	Art. N°	Porte-outils Halter Holders	Pages Seiten Pages	Module de serrage Spannelement Clamping unit	Module d'arrosage Kühlmittelzufuhrelement Coolant supply unit	Page Seite Page
7T	ML12-P034-1-7T	ML12	> 11.60	-	ML12-JET-5/16	11.78
10T	ML12-P034-2-10T					

Les différents types de porte-outils
Die verschiedenen Haltertypen
The various types of holders

Type Standard

ML12A-740



Type -D

ML12A-740-D



Type -JET-D

ML12A-740-JET-D

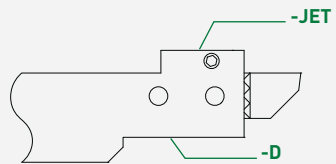
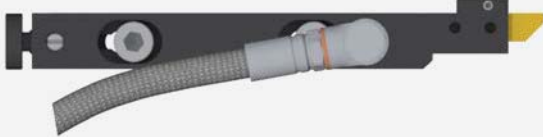

Type -JET

ML12A-740-JET

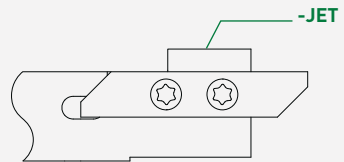

Informations techniques
 Technische Informationen
 Technical information

Porte-outils
 Halter
 Holders

Compatibilité
 Kompatibilität
 Compatibility

OK

KO

-JET-D -D

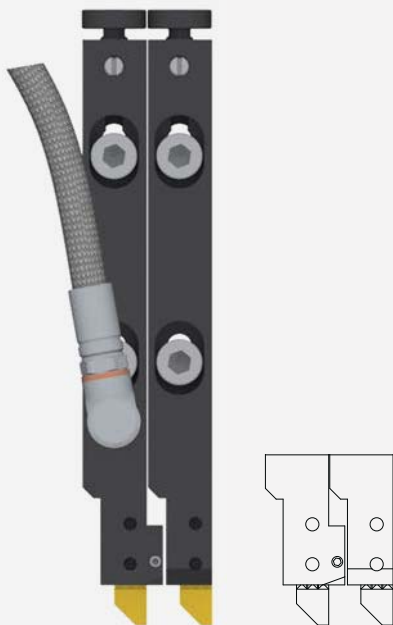

-JET-D -Standard

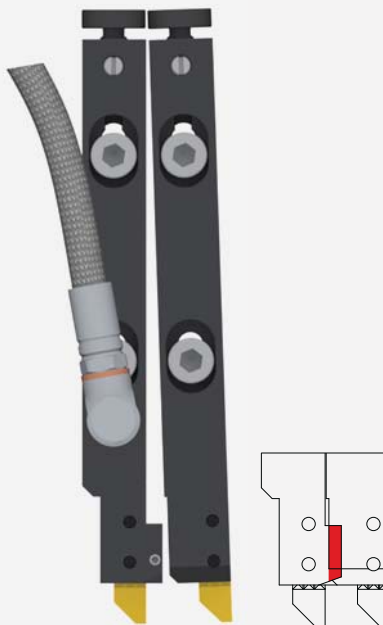

MIX

TYPE D

-Standard -JET-D -D



-JET-D -D -JET-D -D

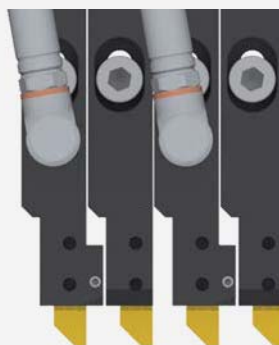

Exceptions
Ausnahmen
Exceptions

Exception ML12



≥ 15 mm = Total compatibility

Exception ML16



≥ 20 mm = Total compatibility

Brochure JET-Line:

Système de distribution du liquide de refroidissement pour haute pression

JET-Line Broschüre:

Kühlmittelverteilungssystem für hohen Druck

JET-Line brochure:

Coolant distribution system for high pressure

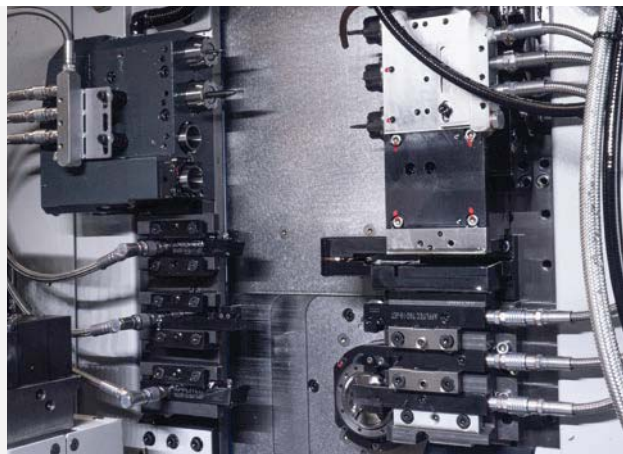

Porte-outils

Halter

Holders

ML12 / ML16

Système de fixation
Befestigungssystem
Clamping system

A = réglable
einstellbar
adjustable

F = longueur fixe
fixlänge
fixed length

ML12A

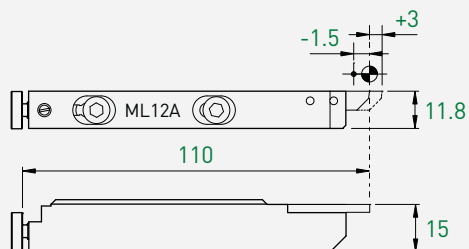

ML12F

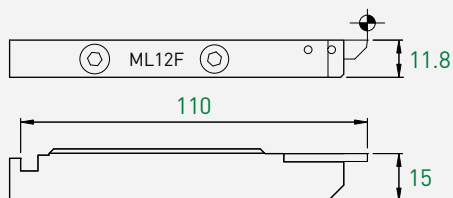

ML16A

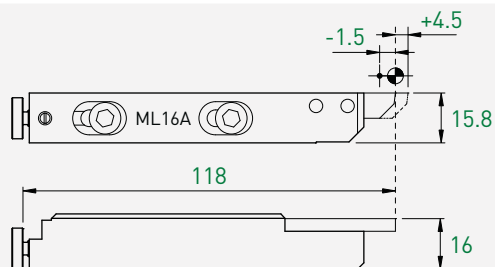

ML16F

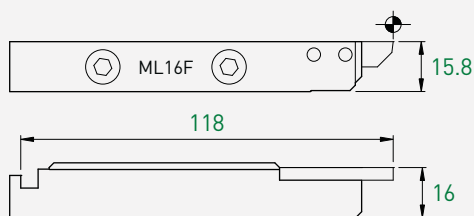

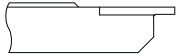

TOP-Line
741-747 > 1.32

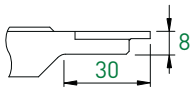

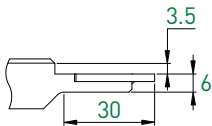

TOP-Line
741-747 > 1.32



TOP-Line
741 > 1.32-1.38

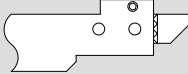

TOP-Line
761-767 > 1.78

Standard	-D	-JET-D
		
Art. N°	Art. N°	Art. N°
ML12	ML12	ML12
ML12A-740	ML12A-740-D	ML12A-740-JET-D
ML12F-740	ML12F-740-D	-
ML16	ML16	ML16
ML16A-740	ML16A-740-D	ML16A-740-JET-D
ML16F-740	-	-

ML12	ML12	ML12
ML12A-740-C	ML12A-740-C-D	ML12A-740-C-JET-D
ML12F-740-C	ML12F-740-C-D	-

ML12	ML12	ML12
ML12A-740-C-R04	-	-
ML12A-740-C-SWISS-NANO	-	-

ML12	ML12	ML12
ML12A-760	ML12A-760-D	ML12A-760-JET-D
ML12F-760	ML12F-760-D	-
ML16	ML16	ML16
ML16A-760	ML16A-760-D	ML16A-760-JET-D
ML16F-760	-	-

Porte-plaquettes

WSP-Halter



Insert holders

TOP-Line



TOP-Line
761-767

> 1.78

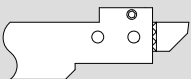
Standard	-D	-JET-D
		
Art. N°	Art. N°	Art. N°
ML16	ML16	ML16
ML16A-760-C	ML16A-760-C-D	-
ML16F-760-C	-	-

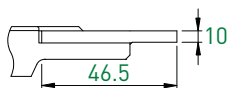

TOP-Line
781

> 1.135

ML16	ML16	ML16
-	ML16A-780-C-D	-

Porte-plaquettes

WSP-Halter



Insert holders

TURN-Line



TURN-Line
347-349

> 6.12

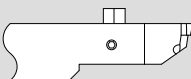
Standard	-D	-JET-D
		
Art. N°	Art. N°	Art. N°
ML12	ML12	ML12
ML12A-340	ML12A-340-D	ML12A-340-JET-D
ML12F-340	ML12F-340-D	-
ML16	ML16	ML16
ML16A-340	ML16A-340-D	ML16A-340-JET-D
ML16F-340	-	-

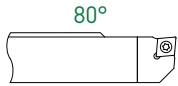

ISO-Line
CC...-0602.. > 7.16

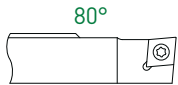

ISO-Line
CC...-09T3.. > 7.16

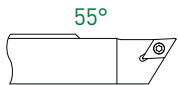

ISO-Line
DC...-0702.. > 7.30



ISO-Line
DC...-11T3.. > 7.30

Standard	-D	-JET-D
Art. N°	Art. N°	Art. N°
ML12	ML12	ML12
ML12A-SCLCR06	ML12A-SCLCR06-D	ML12A-SCLCR06-JET-D
ML12F-SCLCR06	ML12F-SCLCR06-D	-
ML16	ML16	ML16
ML16A-SCLCR06	ML16A-SCLCR06-D	ML16A-SCLCR06-JET-D
ML16F-SCLCR06	ML16F-SCLCR06-D	-

ML12	ML12	ML12
ML12A-SCLCR09	ML12A-SCLCR09-D	ML12A-SCLCR09-JET-D
ML12F-SCLCR09	ML12F-SCLCR09-D	-
ML16	ML16	ML16
ML16A-SCLCR09	ML16A-SCLCR09-D	ML16A-SCLCR09-JET-D
ML16F-SCLCR09	ML16F-SCLCR09-D	-

ML12	ML12	ML12
ML12A-SDJCR07	ML12A-SDJCR07-D	ML12A-SDJCR07-JET-D
ML12F-SDJCR07	ML12F-SDJCR07-D	-
ML16	ML16	ML16
ML16A-SDJCR07	ML16A-SDJCR07-D	ML16A-SDJCR07-JET-D
ML16F-SDJCR07	ML16F-SDJCR07-D	-

ML12	ML12	ML12
ML12A-SDJCR11	ML12A-SDJCR11-D	ML12A-SDJCR11-JET-D
ML12F-SDJCR11	ML12F-SDJCR11-D	-
ML16	ML16	ML16
ML16A-SDJCR11	ML16A-SDJCR11-D	ML16A-SDJCR11-JET-D
ML16F-SDJCR11	ML16F-SDJCR11-D	-

Porte-plaquettes

WSP-Halter

Insert holders

ISO-Line

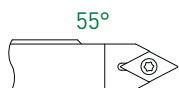

ISO-Line
DC..-11T3.. > 7.30

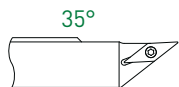

ISO-Line
VC..-1103.. > 7.44

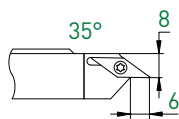

ISO-Line
VC..-1103.. > 7.44

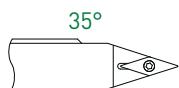

ISO-Line
VC..-1103.. > 7.44

Standard	-D	-JET-D
Art. N°	Art. N°	Art. N°
ML12	ML12	ML12
ML12A-SDNCN11	ML12A-SDNCN11-D	-
ML12F-SDNCN11	ML12F-SDNCN11-D	-
ML16	ML16	ML16
ML16A-SDNCN11	ML16A-SDNCN11-D	-
ML16F-SDNCN11	ML16F-SDNCN11-D	-

ML12	ML12	ML12
ML12A-SVJCR11	ML12A-SVJCR11-D	ML12A-SVJCR11-JET-D
ML12F-SVJCR11	ML12F-SVJCR11-D	-
ML16	ML16	ML16
ML16A-SVJCR11	ML16A-SVJCR11-D	ML16A-SVJCR11-JET-D
ML16F-SVJCR11	ML16F-SVJCR11-D	-

-	ML12	ML12
ML12A-SV-CR11	ML12A-SV-CR11-D	-
ML16	ML16	ML16
ML16A-SV-CR11	ML16A-SV-CR11-D	-

ML12	ML12	ML12
ML12A-SVVCN11	ML12A-SVVCN11-D	-
ML12F-SVVCN11	ML12F-SVVCN11-D	-
ML16	ML16	ML16
ML16A-SVVCN11	ML16A-SVVCN11-D	-
ML16F-SVVCN11	ML16F-SVVCN11-D	-

MODU-LINE

Porte-plaquettes

WSP-Halter

Insert holders

ISO-Line

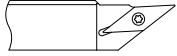

ISO-Line
VC..-1303..

> 7.46

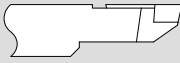
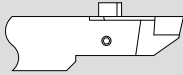
Standard	-D	-JET-D
		
Art. N°	Art. N°	Art. N°
ML12	ML12	ML12
-	ML12A-SVJCR13-D	-
ML16	ML16	ML16
-	ML16A-SVJCR13-D	ML16A-SVJCR13-JET-D

Porte-plaquettes

WSP-Halter

Insert holders

EVOCUT-Line

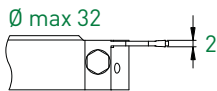

EVOCUT-Line
ET20..

> 8.12

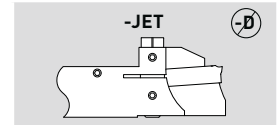

Art. N°	Art. N°	Art. N°
ML16	ML16	ML16
-	-	ML16A-ET20-JET32

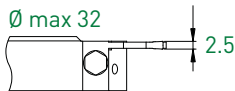

EVOCUT-Line
ET25..

> 8.12

ML16	ML16	ML16
-	-	ML16A-ET25-JET32

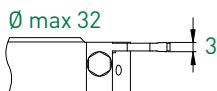

EVOCUT-Line
ET30..

> 8.12

ML16	ML16	ML16
-	-	ML16A-ET30-JET32

Porte-plaquettes

WSP-Halter

Insert holders

CUT-Line

Standard

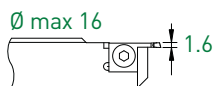
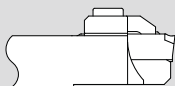

CUT-Line
CUT16..

> 9.14

Art. N°	Art. N°	Art. N°
ML12	ML12	ML12
ML12A-CUT16	-	-
ML12F-CUT16	-	-
ML16	ML16	ML16
ML16A-CUT16	-	-
ML16F-CUT16	-	-

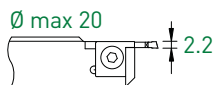

CUT-Line
CUT22..

> 9.14

ML12	ML12	ML12
ML12A-CUT22	-	-
ML12F-CUT22	-	-
ML16	ML16	ML16
ML16A-CUT22	-	-
ML16F-CUT22	-	-

MODU-LINE

Porte-plaquettes
WSP-Halter
Insert holders

PRO-Line

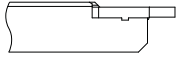

PRO-Line
642-647 > 3.08

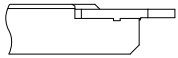

PRO-Line
661 > 3.34

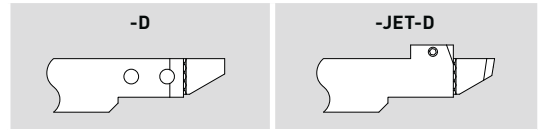

Art. N°	Art. N°	Art. N°
ML12	ML12	ML12
-	ML12A-640-D	ML12A-640-JET-D
ML16	ML16	ML16
-	ML16A-640-D	ML16A-640-JET-D

ML12	ML12	ML12
-	ML12A-660-D	ML12A-660-JET-D
ML16	ML16	ML16
-	ML16A-660-D	ML16A-660-JET-D

Porte-plaquettes
WSP-Halter
Insert holders

ECO-Line

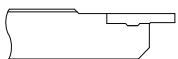

ECO-Line
261-266 > 4.08

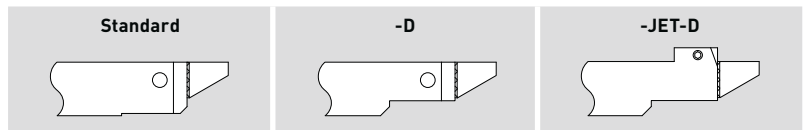

Standard	-D	-JET-D
Art. N°	Art. N°	Art. N°
ML12	ML12	ML12
ML12A-260	ML12A-260-D	ML12A-260-JET-D
ML12F-260	ML12F-260-D	-
ML16	ML16	ML16
ML16A-260	ML16A-260-D	ML16A-260-JET-D
ML16F-260	-	-

Porte-outils

Halter

Holders

IN-Line

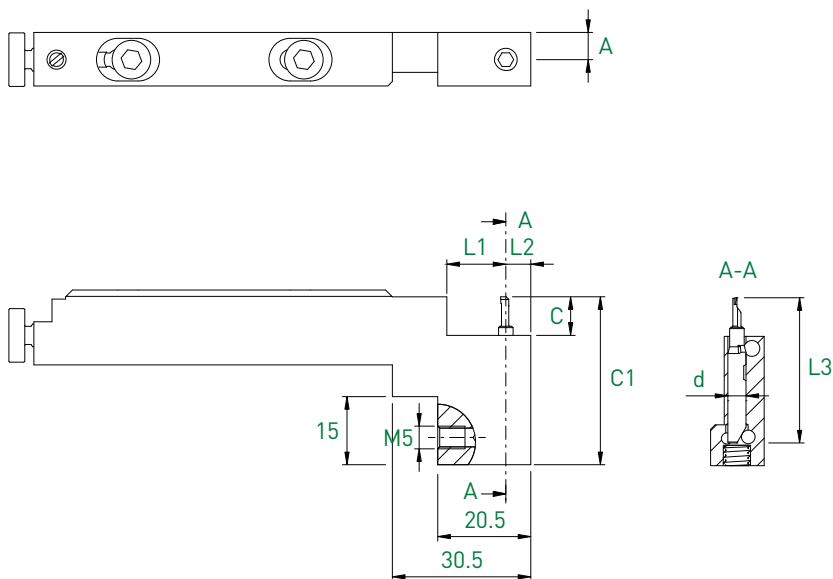

							ML12	
d	Compatible bars L3	C	C1	A	L1	L2	Art. N°	
4	BB4R...	32	8.5	37	6	13	5.5	ML12A-BHK4N-32R-D
	BF4R...	37	13.5	42	6	13	5.5	ML12A-BHK4N-37R-D
		42	18.5	47	6	13	5.5	ML12A-BHK4N-42R-D

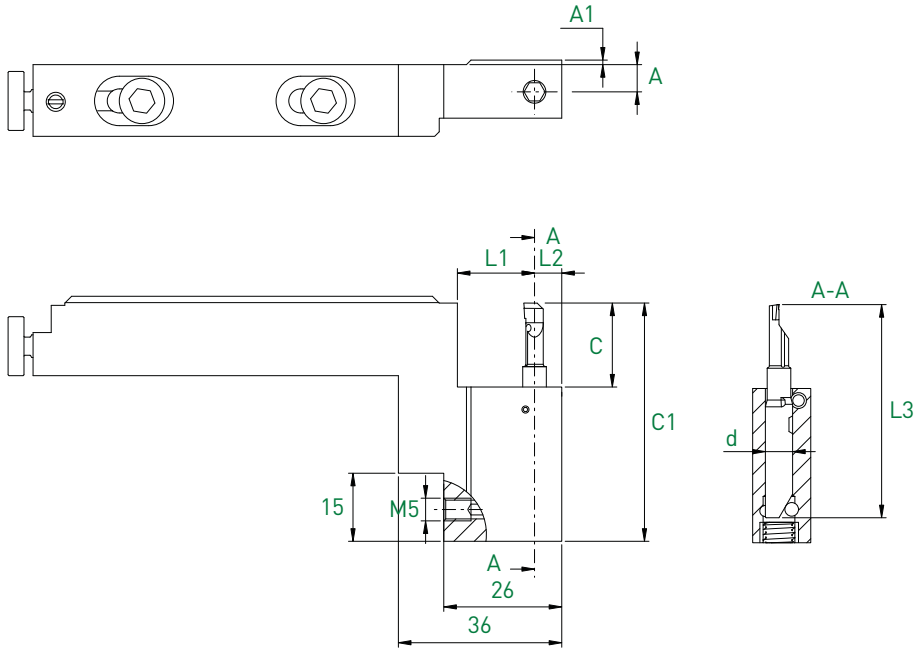

									ML16
d	Compatible bars L3	C	C1	A	A1	L1	L2	Art. N°	
4	BB4R...	32	8.5	37	6	-	17.5	5.5	ML16A-BHK4N-32R-D
	BF4R...	37	13.5	42	6	-	17.5	5.5	ML16A-BHK4N-37R-D
		42	18.5	47	6	-	17.5	5.5	ML16A-BHK4N-42R-D

									ML16
d	Compatible bars L3	C	C1	A	A1	L1	L2	Art. N°	
6	BB4R...	47	18.5	52.5	6	1	17	6	ML16A-BHK6N-47R-D
	BF4R...	57	28.5	62.5	6	1	17	6	ML16A-BHK6N-57R-D

Porte-outils

Halter

Holder

TOOLING-Line

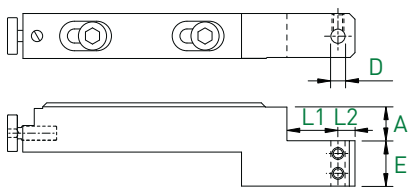

					ML12
A	D	E	L1	L2	Art. N°
8	3	12	13	6	ML12A-2440-8-3
8	4	12	13	6	ML12A-2440-8-4
8	5	12	13	6	ML12A-2440-8-5
12	6	12	13	6	ML12A-2440-12-6

					ML16
A	D	E	L1	L2	Art. N°
12	3	16	18	6	ML16A-2440-12-3
12	4	16	18	6	ML16A-2440-12-4
12	5	16	18	6	ML16A-2440-12-5
12	6	16	18	6	ML16A-2440-12-6
18	8	16	18	6	ML16A-2440-18-8

Porte-molettes

Rändelhalter

Knurl holders

TOOLING-Line

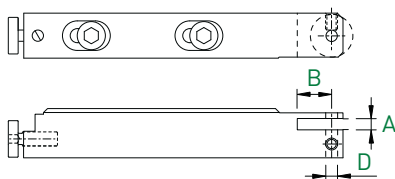

			ML12
A	D	B	Art. N°
4	4	8	ML12A-2402-44

			ML16
A	D	B	Art. N°
4	4	11	ML16A-2402-44

MODU-LINE

Porte-plaquettes – Coupe déportée & contre-opération

WSP-Halter – Versetztes Schneiden & Gegenspindel

Insert holders – Cut off line & cut on subspindle

Coupe à droite déportée ou usinage
à gauche sur contre-broche

Rechtsschneidend versetzt oder
linksschneidend auf Gegenspindel

Right hand cut off line or left hand
cut on subspindle

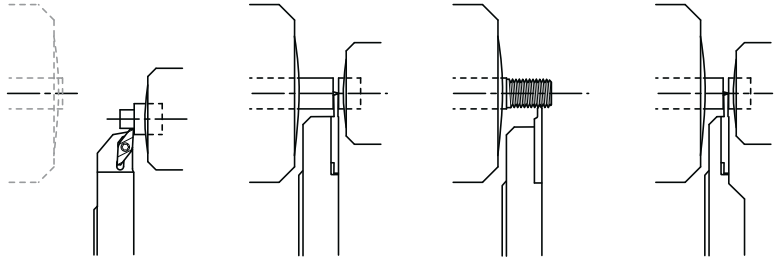

TURN-Line
ISO-Line

TOP-Line
EVOCUT-Line
CUT-Line
PRO-Line
ECO-Line

TOP-Line
EVOCUT-Line
CUT-Line
PRO-Line
ECO-Line

TOP-Line
PRO-Line
ECO-Line

Porte-plaquettes – Coupe déportée & contre-opération

WSP-Halter – Versetztes Schneiden & Gegenspindel

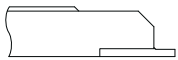

Insert holders – Cut off line & cut on subspindle

TOP-Line



TOP-Line
731-737

> 1.32

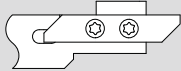



Standard	-D	-JET-D
		
Art. N°	Art. N°	Art. N°
ML12	ML12	ML12
ML12A-730-V	ML12A-730-V-D	ML12A-730-V-JET-D
ML16	ML16	ML16
ML16A-730-V	ML16A-730-V-D	ML16A-730-V-JET-D

Porte-plaquettes – Coupe déportée & contre-opération

WSP-Halter – Versetztes Schneiden & Gegenspindel

Insert holders – Cut off line & cut on subspindle

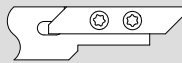
TOP-Line

Standard	-D	-JET 
		
Art. N°	Art. N°	Art. N°
ML12	ML12	ML12
ML12A-730RC	-	ML12A-730RC-JET

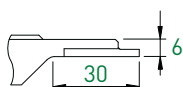

TOP-Line 731R > 1.39

ML16	ML16	ML16
ML16A-730RC	ML16A-730RC-D	ML16A-730RC-JET-D

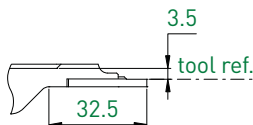

TOP-Line 731R > 1.39

ML12	ML12	ML12
ML12A-730RC-R04	-	-
ML12A-730RC-SWISS-NANO	-	-



TOP-Line 751-757 > 1.78

ML12	ML12	ML12
ML12A-750-V	ML12A-750-V-D	ML12A-750-V-JET-D
ML16	ML16	ML16
ML16A-750-V	ML16A-750-V-D	ML16A-750-V-JET-D

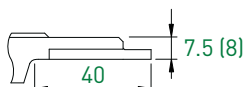

TOP-Line 751R > 1.88

ML12	ML12	ML12
ML12A-750RC	-	-
ML16	ML16	ML16
ML16A-750RC	ML16A-750RC-D	ML16A-750RC-JET-D

MODU-LINE

Porte-plaquettes – Coupe déportée & contre-opération



WSP-Halter – Versetztes Schneiden & Gegenspindel

Insert holders – Cut off line & cut on subspindle

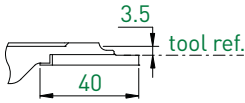
TOP-Line

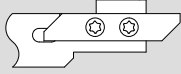

TOP-Line
751R > 1.88

Standard	-D	-JET-D
		
Art. N°	Art. N°	Art. N°
ML12	ML12	ML12
ML12A-750RC-R04	-	-
ML12A-750RC-SWISS-NANO	-	-

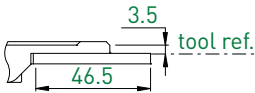

TOP-Line
771R > 1.137

ML12	ML12	ML12
ML12A-770RC-SWISS-NANO	-	-

Porte-plaquettes – Contre-opération



WSP-Halter – Gegenspindel

Insert holders – Cut on subspindle

TURN-Line

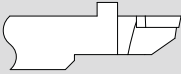

TURN-Line
337-339 > 6.12

Standard	-D	-JET-D
		
Art. N°	Art. N°	Art. N°
ML12	ML12	ML12
ML12A-330-V	ML12A-330-V-D	ML12A-330-V-JET-D
ML16	ML16	ML16
ML16A-330-V	ML16A-330-V-D	ML16A-330-V-JET-D

Porte-plaquettes – Contre-opération

WSP-Halter – Gegenspindel

Insert holders – Cut on subspindle

ISO-Line

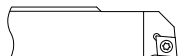

ISO-Line
CC...0602..

> 7.16

Standard	-D	-JET-D
Art. N°	Art. N°	Art. N°
ML12	ML12	ML12
-	ML12A-SCLCL06-V-D	ML12A-SCLCL06-V-JET-D
ML16	ML16	ML16
-	ML16A-SCLCL06-V-D	ML16A-SCLCL06-V-JET-D

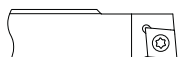

ISO-Line
CC...9T3..

> 7.16

ML12	ML12	ML12
-	ML12A-SCLCL09-V-D	ML12A-SCLCL09-V-JET-D
ML16	ML16	ML16
-	ML16A-SCLCL09-V-D	ML16A-SCLCL09-V-JET-D



ISO-Line
CC...0702..

> 7.16

ML12	ML12	ML12
-	ML12A-SDJCL07-V-D	ML12A-SDJCL07-V-JET-D
ML16	ML16	ML16
-	ML16A-SDJCL07-V-D	ML16A-SDJCL07-V-JET-D



ISO-Line
DC...11T3..

> 7.30

ML12	ML12	ML12
ML12A-SDJCL11-V	ML12A-SDJCL11-V-D	ML12A-SDJCL11-V-JET-D
ML16	ML16	ML16
ML16A-SDJCL11-V	ML16A-SDJCL11-V-D	ML16A-SDJCL11-V-JET-D

MODU-LINE

Porte-plaquettes – Contre-opération

WSP-Halter – Gegenspindel

Insert holders – Cut on subspindle

ISO-Line

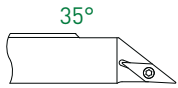

ISO-Line
VC...1103.. > 7.44

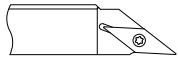

ISO-Line
VC...1303.. > 7.46

Standard	-D	-JET-D
Art. N°	Art. N°	Art. N°
ML12	ML12	ML12
ML12A-SVJCL11-V	ML12A-SVJCL11-V-D	ML12A-SVJCL11-V-JET-D
ML16	ML16	ML16
ML16A-SVJCL11-V	ML16A-SVJCL11-V-D	ML16A-SVJCL11-V-JET-D

ML12	ML12	ML12
-	ML12A-SVJCL13-V-D	-
ML16	ML16	ML16
-	ML16A-SVJCL13-V-D	ML16A-SVJCL13-V-JET-D

Porte-plaquettes – Coupe déportée

WSP-Halter – Versetztes Schneiden

Insert holders – Cut off line

EVO CUT-Line

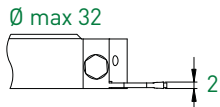

EVO CUT-Line
ET20 > 8.12

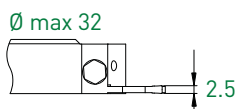

EVO CUT-Line
ET25 > 8.12

-JET		
Art. N°	Art. N°	Art. N°
ML16	ML16	ML16
-	-	ML16A-ET20-V-JET-32

ML16	ML16	ML16
-	-	ML16A-ET25-V-JET-32

Porte-plaquettes – Coupe déportée

WSP-Halter – Versetztes Schneiden

Insert holders – Cut off line

EVOCUT-Line

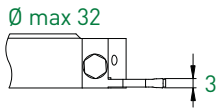

EVOCUT-Line
ET30 > 8.12

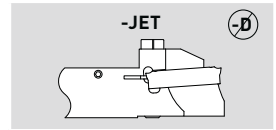

ML16	ML16	ML16
-	-	ML16A-ET30-V-JET-32

Porte-plaquettes – Coupe déportée

WSP-Halter – Versetztes Schneiden

Insert holders – Cut off line

CUT-Line

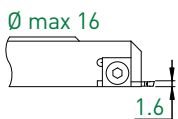

CUT-Line
CUT16 > 9.14

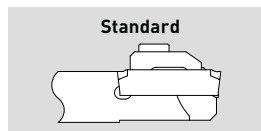

Art. N°	Art. N°	Art. N°
ML12	ML12	ML12
ML12A-CUT16-V	-	-
ML12F-CUT16-V	-	-
ML16	ML16	ML16
ML16A-CUT16-V	-	-
ML16F-CUT16-V	-	-

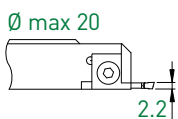

CUT-Line
CUT22 > 9.14

ML12	ML12	ML12
ML12A-CUT22-V	-	-
ML12F-CUT22-V	-	-
ML16	ML16	ML16
ML16A-CUT22-V	-	-
ML16F-CUT22-V	-	-

Porte-plaquettes – Coupe déportée & contre-opération

WSP-Halter – Versetztes Schneiden & Gegenspindel



Insert holders – Cut off line & cut on subspindle

PRO-Line

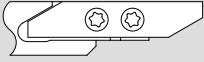

PRO-Line
632-636

> 3.08

Standard	-D	-JET-D
		
Art. N°	Art. N°	Art. N°
ML12	ML12	ML12
-	ML12A-630-V-D	ML12A-630-V-JET-D
ML16	ML16	ML16
-	ML16A-630-V-D	ML16A-630-V-JET-D

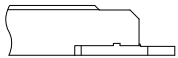

PRO-Line
651R

> 3.39

ML12	ML12	ML12
-	ML12A-650-V-D	ML12A-650-V-JET-D
ML16	ML16	ML16
-	ML16A-650-V-D	ML16A-650-V-JET-D

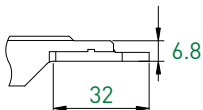

PRO-Line
651R

> 3.39

ML12	ML12	ML12
ML12A-650RC	ML12A-650RC-D	-
ML16	ML16	ML16
-	ML16A-650RC-D	ML16A-650RC-JET-D

Porte-plaquettes – Coupe déportée & contre-opération

WSP-Halter – Versetztes Schneiden & Gegenspindel



Insert holders – Cut off line & cut on subspindle

ECO-Line



ECO-Line
251-261

> 4.08

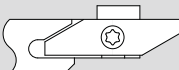
Standard	-D	-JET-D
		
Art. N°	Art. N°	Art. N°
ML12	ML12	ML12
ML12A-250-V	ML12A-250-V-D	ML12A-250-V-JET-D
ML16	ML16	ML16
ML16A-250-V	ML16A-250-V-D	ML16A-250-V-JET-D

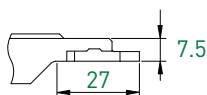

ECO-Line
251R

> 4.08

ML12	ML12	ML12
-	ML12A-250RC-D	-
ML16	ML16	ML16
-	ML16A-250RC-D	-

MODU-LINE

Modules d'arrosage
Kühlmittelzufuhrelemente
Coolant supply units

ML12 / ML16

ML12

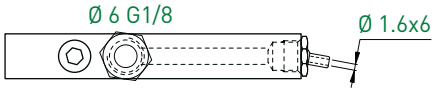

Raccord Anschluss Connection	Buses d'arrosage Kühlmitteldüse Coolant nozzles	ML12 Art. N°
Ø 6 G 1/8	5/16"	ML12-JET-5/16

ML16

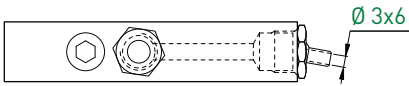

Raccord Anschluss Connection	Buses d'arrosage Kühlmitteldüse Coolant nozzles	ML16 Art. N°
Ø 6 G 1/8	7/16"	ML16-JET-7/16

buses optionnelles voir page 11.79
zusätzliche Düsen siehe Seite 11.79
optional nozzles see page 11.79

Modules de serrage
Spannelemente
Clamping units

ML12 / ML16

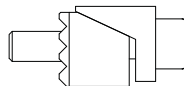
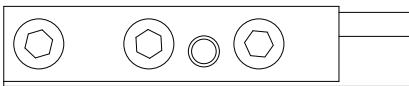

ML12 Art. N°	ML16 Art. N°
ML12-FIX-12/14	ML16-FIX-16/16
-	ML16-FIX-16/16.5
-	ML16-FIX-16/17
-	ML16-FIX-16/20
-	ML16-FIX-16/22
-	ML16-FIX-16/24

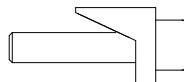
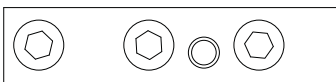

ML12 Art. N°	ML16 Art. N°
ML12-FIX-12	ML16-FIX-16

Buses d'arrosage
Kühlmitteldüsen
Coolant nozzles

5/16" / 7/16"

JET

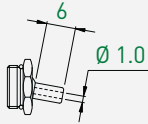
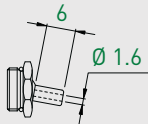
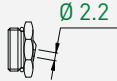
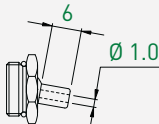
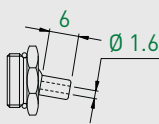
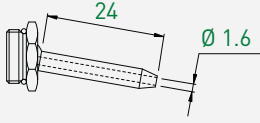
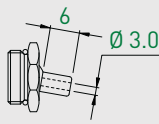
5/16"	Art. N°	Références compatibles Kompatible Artikeln Compatible items
	ML-JET 5/16-1.0x6	ML12-JET-5/1
	ML-JET 5/16-1.6x6	une buse ML-JET-5/16-1.6x6 est comprise eine Düse ML-JET-5/16-1.6x6 ist inbegriffen a nozzle ML-JET-5/16-1.6 x6 is included
	ML-JET 5/16-2.2x0	
7/16"	Art. N°	Références compatibles Kompatible Artikeln Compatible items
	ML-JET 7/16-1.0x6	
	ML-JET 7/16-1.6x6	ML16-KMX26-JET ML16-JET-7/16 ML12-DEC010-JET ML16-DEC013-JET ML16-DEC020-JET ML16-S20-JET ML16-SWISS-ST26-JET
	ML-JET-7/16-1.6x24	une buse ML-JET-7/16-3.0x6 est comprise avec chaque article ci-dessus eine Düse ML-JET 7/16-3.0x6 ist mit jedem vorstehenden Artikel inbegriffen
	ML-JET-7/16-3.0x6	a nozzle ML-JET 7/16-3.0x6 is included with each above item

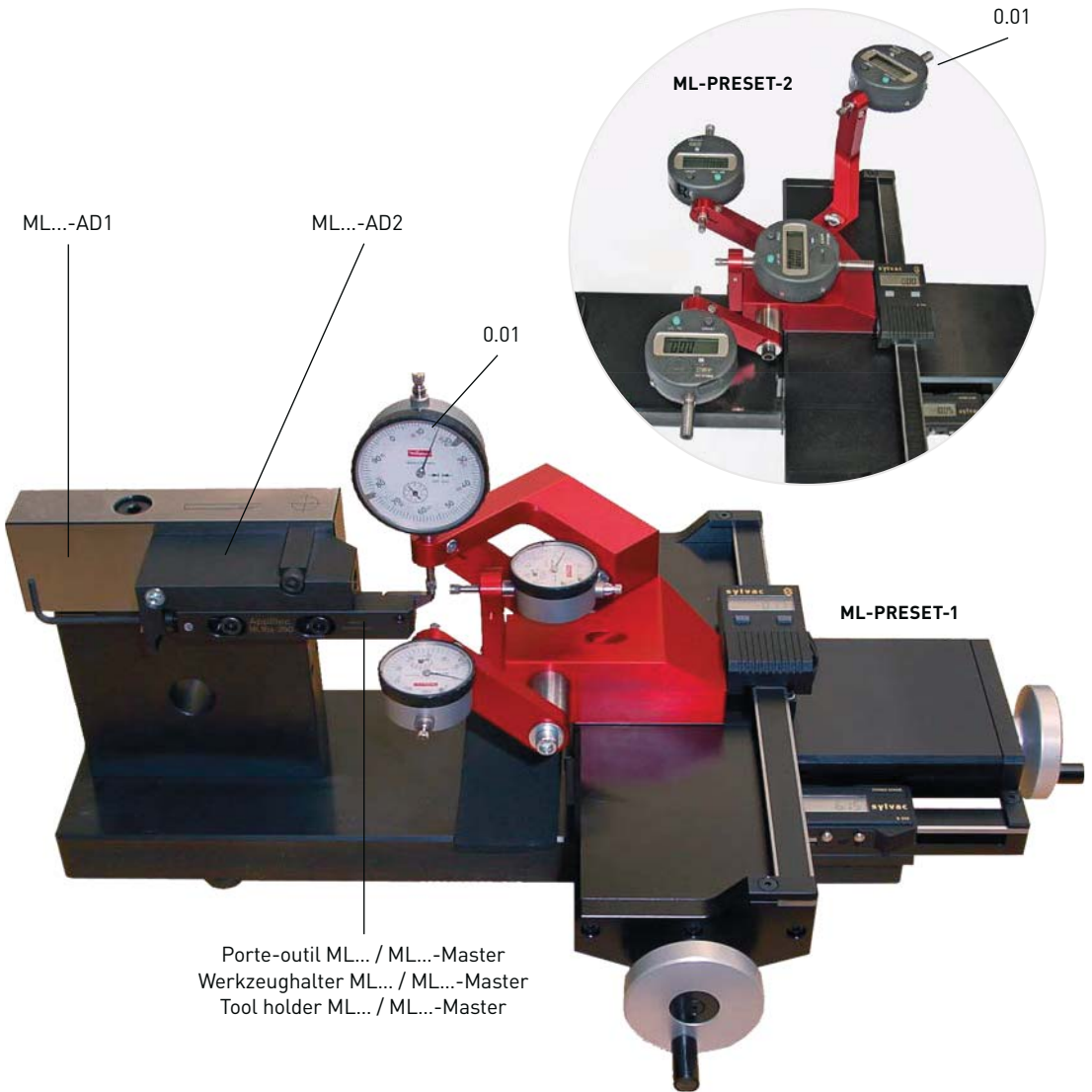

Art. N°

ML-PRESET-1

ML-PRESET-2

Banc de pré réglage

Voreinstellgerät

Presetting device

ML12 / ML16

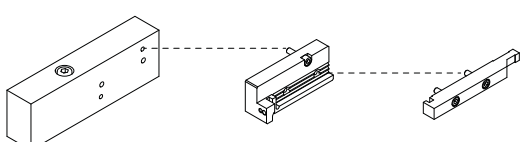
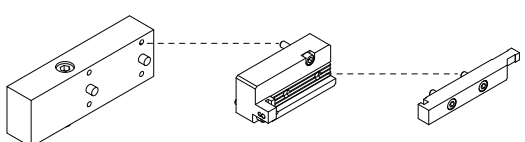
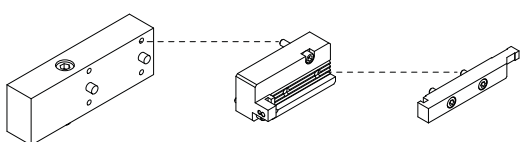
Type Typ Type	Machines Maschinen Machines	Adaptation Anpassungen Adapter	Adaptateurs et jauges d'étalonnage Adapter und Einstellehre Adaptators and master gauges
ML12	CITIZEN	C12/C16	 <p>ML12-AD1 ML12-AD2 ML12-MASTER</p>
		L12	
		R04	
		R07	
	HANWHA	XD20M	
	METAFIL	D10	
	STAR	SB12RG	
		SR10-J	
		SW12R11	
	TORNOS	DECO7/10 - EvoDECO 10	
		SWISS-NANO	
		SWISS-NANO 7	
		DT13	
		CT20	
TSUGAMI	GT13		
	B074		
	B075		
	P034		
ML16	CITIZEN	K16	 <p>ML16/20-AD1 ML16-AD2 ML16-MASTER</p>
		L20	
		L20E	
	HANWHA	SL12/16	
	MANUHRIN	KMX 426/526/626	
		SA-12/SA16/SA16R	
	STAR	SB16	
		SB16/20RG	
		SB20	
		SR20J	
		SR20R	
		SR20R111	
		SR20R1V	
		SR32J	
		SV12/20	
		SW20R	
	TORNOS	DECO20/26 - EvoDECO20/32	
		SIGMA20/32	
DT26			
GT26			
GT32			
ML16	TORNOS	DECO13- EvoDECO16	 <p>ML16-DECO13-AD1 ML16-DECO13-AD2 ML16-MASTER</p>
ST26			

ML12

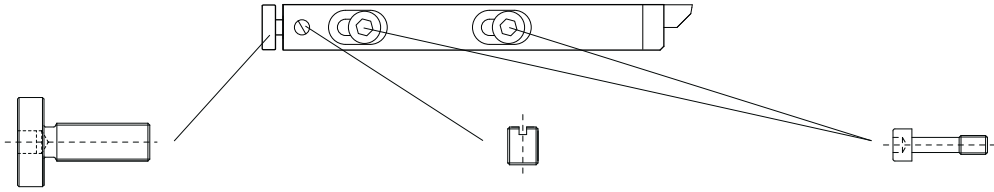

Vis de réglage
 Einstellungsschraube
 Setting screw

Art. N°

ML12A-M5X0.5

Vis de blocage
 Blockierschraube
 Locking screw

Art. N°

ML-M4X4-T

Vis de fixation
 Befestigungsschraube
 Fixing screw

Art. N°

ML12-M5XL20

ML16

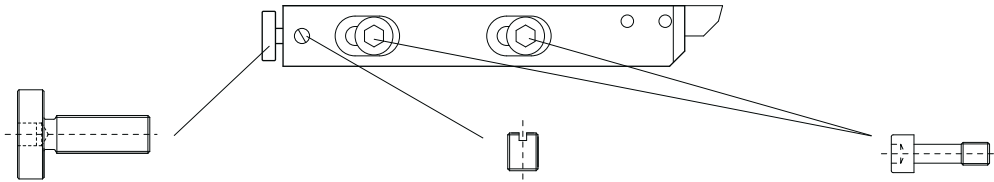

Vis de réglage
 Einstellungsschraube
 Setting screw

Art. N°

ML16A-M5X0.5

Vis de blocage
 Blockierschraube
 Locking screw

Art. N°

ML-M4X4-T

Vis de fixation
 Befestigungsschraube
 Fixing screw

Art. N°

ML16/20-M6XL20

Art. N°

ML-205004



Butée à ressort
 Federnde Schraube
 Spring bumper

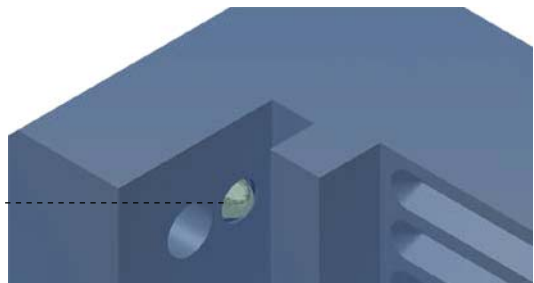



Pièces de rechange

Ersatzteile

Spare parts

ML12 / ML16

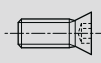
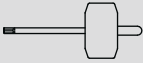
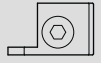
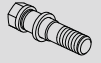
Vis et clés pour le serrage des plaquettes
Schrauben und Schlüssel für WSP-Befestigung
Screws and keys for insert clamping

Porte-outils Halter Holders					
ML...250	V-M4X9-T15	C-T15	-	-	-
ML...260	V-M2.5X7.8-T8	C-T8	-	-	-
ML...330	V-M2.5X7.8-T8	C-T8	-	-	-
ML...340	V-M2.5X7.8-T8	C-T8	-	-	-
ML...630	V-M4X9-T15	C-T15	-	-	-
ML...640	V-M4X9-T15	C-T15	-	-	-
ML...650	V-M4X9-T15	C-T15	-	-	-
ML...650RC	V-M4X6.5-T15	C-T15	-	-	-
ML...660	V-M4X9-T15	C-T15	-	-	-
ML...730	V-M3X7-T8	C-T8	-	-	-
ML...730RC	V-M3X5.5-T8	C-T8	-	-	-
ML...730RC-R04	V-M3X4.5-T8 V-M3X7-T8	C-T8	-	-	-
ML...730RC-SWISS-NANO	V-M3X4.5-T8 V-M3X7-T8	C-T8	-	-	-
ML...740	V-M3X7-T8	C-T8	-	-	-
ML...750	V-M4X9-T15	C-T15	-	-	-
ML...750RC	V-M4X7.3-T15	C-T15	-	-	-
ML...750RC-R04	V-M4X5.6-T15 V-M4X7.3-T15	C-T15	-	-	-
ML...750RC-SWISS-NANO	V-M4X5.6-T15 V-M4X7.3-T15	C-T15	-	-	-
ML...760	V-M4X9-T15	C-T15	-	-	-
ML...770RC-SWISS-NANO	V-M4X7.3-T15	C-T15	-	-	-
ML...780	V-M4X9-T15	C-T15	-	-	-
ML...SC...06	V-M2.5X5.8-T8	C-T8	-	-	-
ML...SC...09	V-M4X7-T15-ISO	C-T15	-	-	-
ML...-SD...07	V-M2.5X7.8-T8	C-T8	-	-	-
ML...-SD...07-D	V-M2.5X5.8-T8	C-T8	-	-	-
ML12...-SDJ...11	V-M4X7-T15-ISO	C-T15	-	-	-
ML12...-SDN...11	V-M4X9-T15-ISO	C-T15	-	-	-
ML16...-SD...11	V-M4X9-T15-ISO	C-T15	-	-	-
ML...-SV...11	V-M2.5X7.8-T8	C-T8	-	-	-
ML...-SV...13	V-M3X7.3-T8-ISO	C-T8	-	-	-
ML...-CUT16	-	-	CUT16RS-SET	-	-
ML...-CUT16-V	-	-	CUT16LS-SET	-	-
ML...-CUT22	-	-	CUT22RS-SET	-	-
ML...-CUT16-V	-	-	CUT22LS-SET	-	-
ML16...-ET... JET32	-	-	-	V-M5X21-6P7-J	C-6PEX-7.0
ML16...-ET... V-JET32	-	-	-	V-M5X21-6P7-J	C-6PEX-7.0

Outils et porte-outils traditionnels pour le décolletage et la mécanique de précision

- Porte-outils
- Forets à centrer
- Burins intérieurs
- Porte-molettes
- Molettes MD

Übliche Werkzeuge und Halter für Decolletage und Präzisionsmechanik

- Werkzeughalter
- Zentrierbohrer
- Innendrehwerkzeuge
- Rändelhalter
- Rändelrädchen

Usual tools and tool holders for automatic lathes and precision mechanics

- Tool holders
- Centring drills
- Internal turning tools
- Knurl holders
- Knurling wheels



Index

Porte-outils
Werkzeughalter
Tool holders

Type 14xx / 24xx



> 12.02

Porte-outils monoblocs pour machines Tornos
Monoblockwerkzeughalter für Tornos Maschinen
Monobloc tool holders for Tornos machines

Type 2435 / 2436

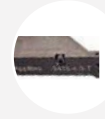

> 12.12

Forets à centrer plats
Zentrierflachbohrer
Centering flat drills

Type 1200 / 2200



> 12.14

Forets à centrer hélicoïdaux
Zentrierspiralbohrer
Centering twist drills

Type 15xx / 25xx



> 12.15

Burins intérieurs en métal dur
Vollhartmetall Innendrehwerkzeuge
Solid carbide internal turning tools

Type 16xx / 26xx

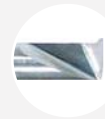

> 12.16

Porte-molettes
Rändelhalter
Knurl holders

Type 1402 / 2402



> 12.18

Molettes en métal dur
Vollhartmetall Rändelrädchen
Solid carbide knurling wheels

Type 1107



> 12.19

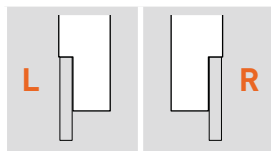
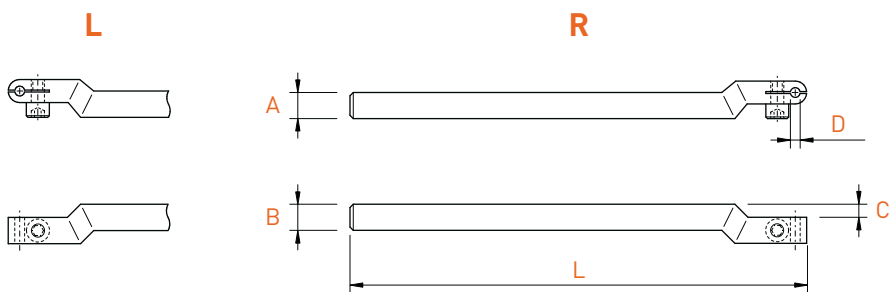

A x B	L	C	D	Art. N°	Art. N°
6 x 6	132	3	1.5	1400-J-615	2400-J-615
6 x 6	132	3	2.0	1400-J-620	2400-J-620
6 x 6	132	3	3.0	1400-J-630	2400-J-630
7 x 7	140	3	1.5	1400-J-715	2400-J-715
7 x 7	140	3	2.0	1400-J-720	2400-J-720
7 x 7	140	3	3.0	1400-J-730	2400-J-730
8 x 8	140	4	1.5	1400-J-815	2400-J-815
8 x 8	140	4	2.0	1400-J-820	2400-J-820
8 x 8	140	4	3.0	1400-J-830	2400-J-830

Porte-outils
 Werkzeughalter
 Tool holders

1401-K / 2401-K

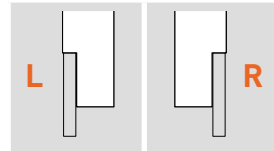
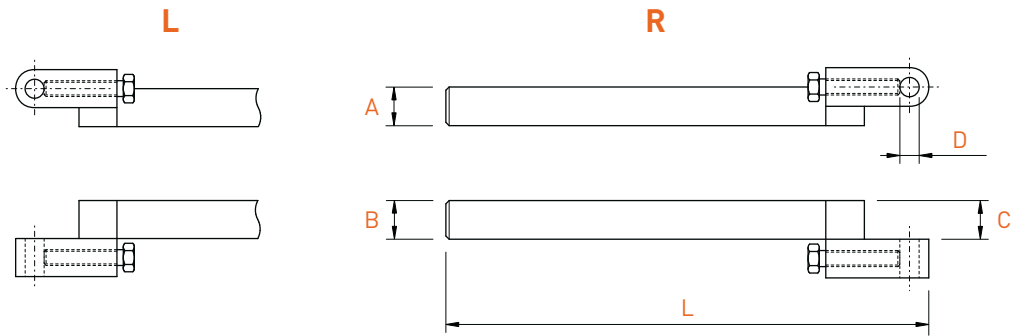

A x B	L	C	D	Art. N°	Art. N°
7 x 7	146	7	2.0	1401-K-720	-
7 x 7	146	7	3.0	1401-K-730	2401-K-730
7 x 7	146	7	4.0	1401-K-740	2401-K-740
8 x 8	146	8	2.0	1401-K-820	-
8 x 8	146	8	3.0	1401-K-830	2401-K-830
8 x 8	146	8	4.0	1401-K-840	2401-K-840
8 x 8	146	8	5.0	1401-K-850	2401-K-850
8 x 8	146	8	6.0	1401-K-860	2401-K-860
10 x 10	150	10	3.0	-	2401-K-1030
10 x 10	150	10	4.0	1401-K-1040	2401-K-1040
10 x 10	150	10	5.0	1401-K-1050	2401-K-1050
10 x 10	150	10	6.0	1401-K-1060	2401-K-1060
10 x 10	150	10	7.0	1401-K-1070	2401-K-1070
12 x 12	150	12	3.0	-	2401-K-1230
12 x 12	150	12	4.0	1401-K-1240	2401-K-1240
12 x 12	150	12	5.0	1401-K-1250	2401-K-1250
12 x 12	150	12	6.0	1401-K-1260	2401-K-1260
12 x 12	150	12	8.0	1401-K-1280	2401-K-1280
14 x 14	150	14	4.0	1401-K-1440	2401-K-1440
14 x 14	150	14	6.0	1401-K-1460	2401-K-1460
14 x 14	150	14	8.0	1401-K-1480	2401-K-1480

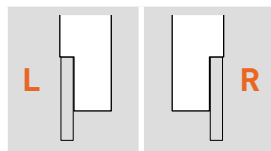
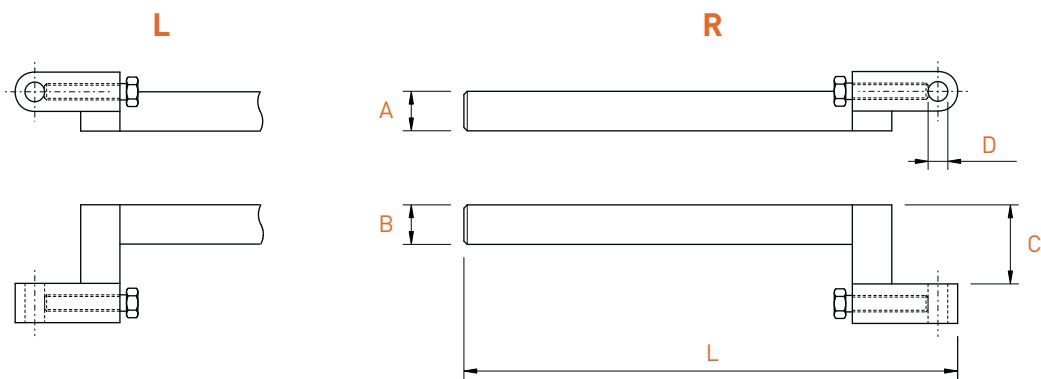

A x B	L	C	D	Art. N°	Art. N°
7 x 7	146	12	4.0	1420-7124	2420-7124
8 x 8	146	12	4.0	1420-8124	2420-8124
8 x 8	146	14	3.0	1420-8143	2420-8143
8 x 8	146	15	5.0	1420-8155	2420-8155
8 x 8	146	20	5.0	1420-8205	2420-8205
10 x 10	150	20	6.0	1420-10206	2420-10206
12 x 12	150	18	6.0	1420-12186	2420-12186
12 x 12	150	18	8.0	1420-12188	-
12 x 12	150	24	8.0	1420-12248	2420-12248
14 x 14	150	20	8.0	1420-14208	2420-14208
14 x 14	150	24	8.0	1420-14248	2420-14248

Porte-outils

Werkzeughalter

Tool holders

∅ 12 x 12

1460

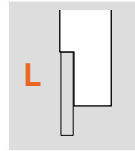
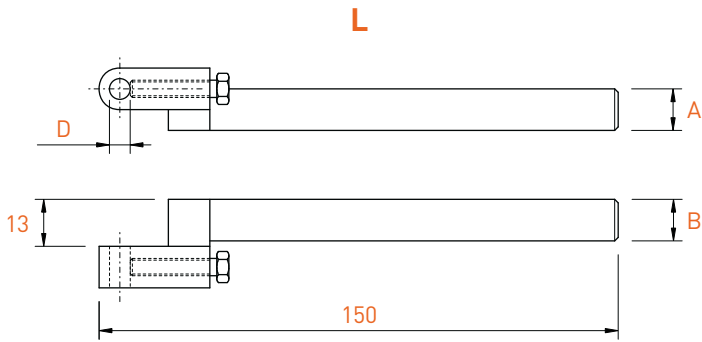

A x B	D	Art. N°
12 x 12	4.0	1460-4
12 x 12	5.0	1460-5
12 x 12	6.0	1460-6
12 x 12	8.0	1460-8

TOOLING-LINE

Porte-outils
Werkzeughalter
Tool holders

∅ 10 x 10

2450-SP

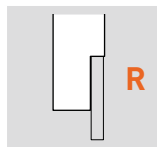
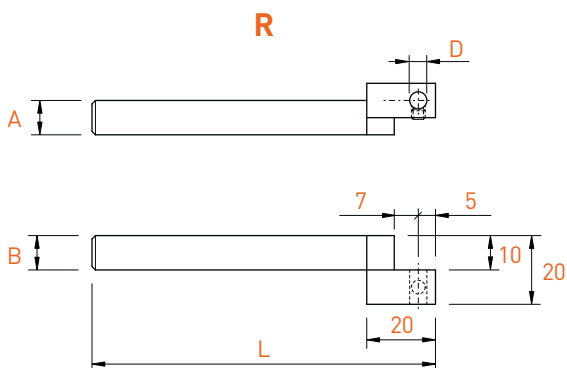

A x B	L	D	Art. N°
10 x 10	100	3.0	2450-SP-3
10 x 10	100	4.0	2450-SP-4
10 x 10	100	5.0	2450-SP-5
10 x 10	100	6.0	2450-SP-6
10 x 10	120	3.0	2450-SP-3-120
10 x 10	120	4.0	2450-SP-4-120
10 x 10	120	5.0	2450-SP-5-120
10 x 10	120	6.0	2450-SP-6-120

Porte-outils
Werkzeughalter
Tool holders

∅ 10 x 10

2470

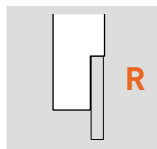
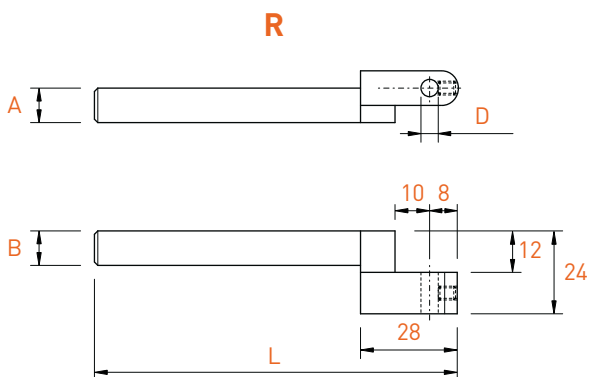

A x B	L	D	Art. N°
10 x 10	105	3.0	2470-3
10 x 10	105	4.0	2470-4
10 x 10	105	5.0	2470-5
10 x 10	105	6.0	2470-6
10 x 10	105	7.0	2470-7

Porte-outils
Werkzeughalter
Tool holders

∅ 12 x 12

2450

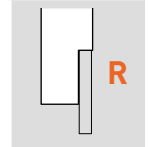
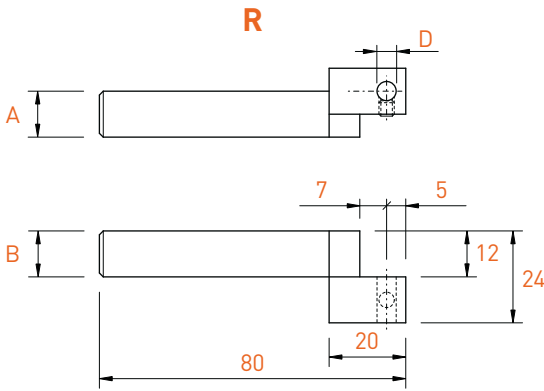

A x B	D	Art. N°
12 x 12	3.0	2450-3
12 x 12	4.0	2450-4
12 x 12	5.0	2450-5
12 x 12	6.0	2450-6
12 x 12	8.0	2450-8

Porte-outils
Werkzeughalter
Tool holders

∅ 12 x 12

2460

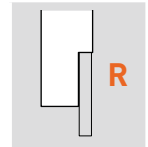
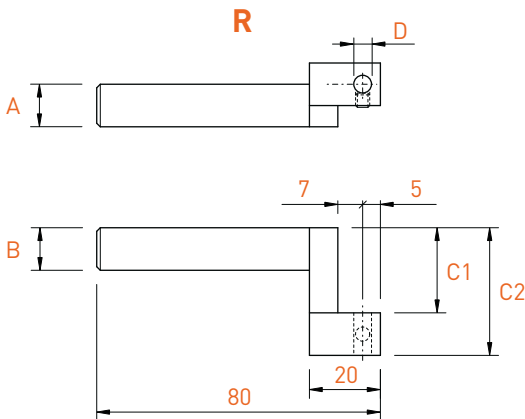

A x B	C1	C2	D	Art. N°
12 x 12	16	28	4.0	2460-284
12 x 12	16	28	6.0	2460-286
12 x 12	16	28	8.0	2460-288
12 x 12	20	32	4.0	2460-324
12 x 12	20	32	6.0	2460-326
12 x 12	20	32	8.0	2460-328
12 x 12	24	36	4.0	2460-364
12 x 12	24	36	6.0	2460-366
12 x 12	24	36	8.0	2460-368

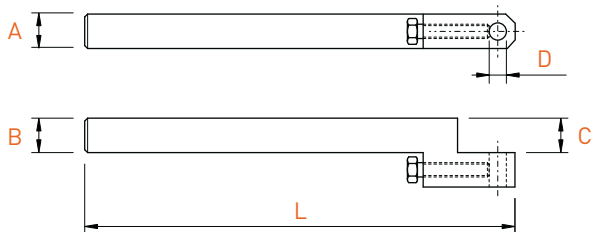

A x B	L	C	D	Art. N°
8 x 8	120	8	3.0	2405-K-830
8 x 8	120	8	4.0	2405-K-840
8 x 8	120	8	5.0	2405-K-850
8 x 8	120	8	6.0	2405-K-860
10 x 10	100	10	4.0	2405-K-1040
10 x 10	100	10	5.0	2405-K-1050
10 x 10	100	10	6.0	2405-K-1060
12 x 12	150	12	4.0	2405-K-1240
12 x 12	150	12	6.0	2405-K-1260
12 x 12	150	12	8.0	2405-K-1280

Porte-outils

Werkzeughalter

Tool holders

2425

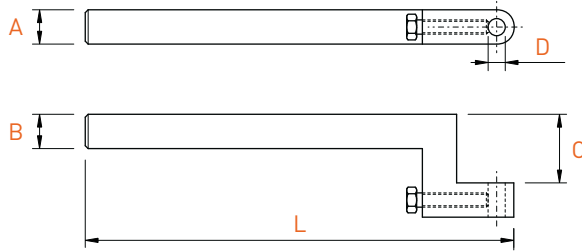

A x B	L	C	D	Art. N°
8 x 8	120	12	4.0	2425-8124
8 x 8	120	15	5.0	2425-8155
8 x 8	120	20	5.0	2425-8205
10 x 10	100	15	6.0	2425-10156
10 x 10	100	20	6.0	2425-10206
12 x 12	150	18	6.0	2425-12186
12 x 12	150	24	8.0	2425-12248

TOOLING-LINE

Porte-outils
Werkzeughalter
Tool holders

□ 12 x 16

2441

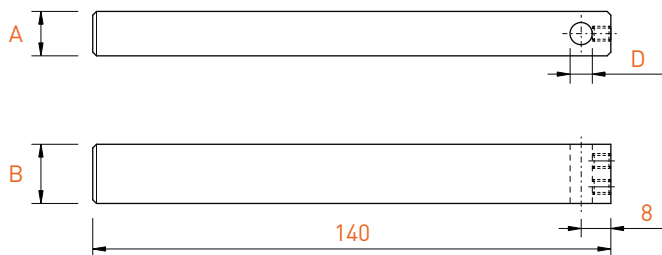

A x B	D	Art. N°
12 x 16	3.0	2441-0-3
12 x 16	4.0	2441-0-4
12 x 16	5.0	2441-0-5
12 x 16	6.0	2441-0-6

Porte-outils
Werkzeughalter
Tool holders

□ 16 x 16

2440-0

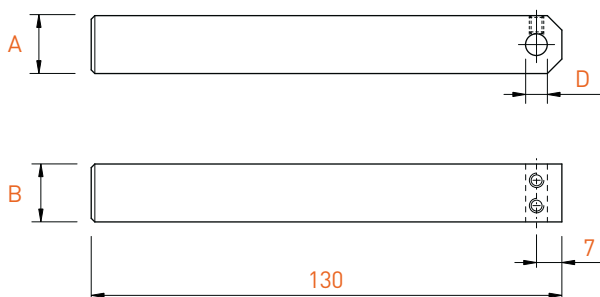

A x B	D	Art. N°
16 x 16	3.0	2440-0-3
16 x 16	4.0	2440-0-4
16 x 16	5.0	2440-0-5
16 x 16	6.0	2440-0-6

Porte-outils
Werkzeughalter
Tool holders

∅ 16 x 16

2440-8 / 2440-12

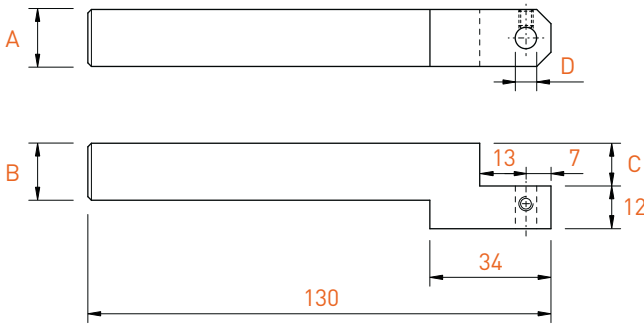

A x B	C	D	Art. N°
16 x 16	8	3.0	2440-8-3
16 x 16	8	4.0	2440-8-4
16 x 16	8	5.0	2440-8-5
16 x 16	8	6.0	2440-8-6
16 x 16	8	8.0	2440-8-8
16 x 16	12	3.0	2440-12-3
16 x 16	12	4.0	2440-12-4
16 x 16	12	5.0	2440-12-5
16 x 16	12	6.0	2440-12-6
16 x 16	12	8.0	2440-12-8

Porte-outils
Werkzeughalter
Tool holders

∅ 16 x 16

2440-18 / 2440-26

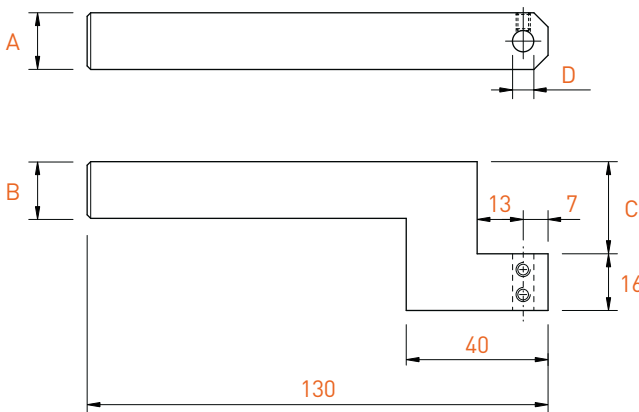

A x B	C	D	Art. N°
16 x 16	18	4.0	2440-18-4
16 x 16	18	5.0	2440-18-5
16 x 16	18	6.0	2440-18-6
16 x 16	18	8.0	2440-18-8
16 x 16	26	4.0	2440-26-4
16 x 16	26	5.0	2440-26-5
16 x 16	26	6.0	2440-26-6
16 x 16	26	8.0	2440-26-8

TOOLING-LINE

Porte-outils pour machines Tornos DECO 7/10 / EvoDECO 10
 Werkzeughalter für Tornos DECO 7/10 / EvoDECO 10 Maschinen
 Tool holders for Tornos DECO 7/10 / EvoDECO 10 machines

2435 / 2435-T

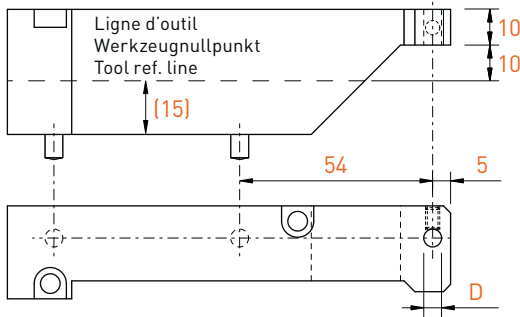

D	Art. N°
3.0	2435-3
4.0	2435-4
5.0	2435-5
6.0	2435-6

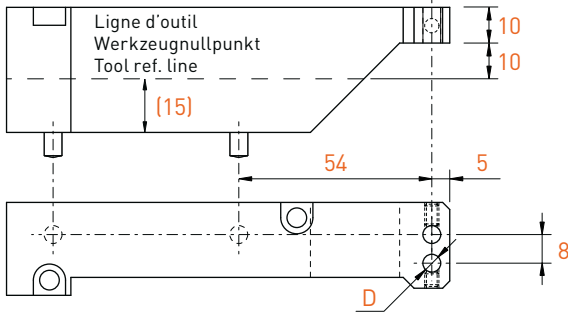

D (2x)	Art. N°
3.0	2435-3-T
4.0	2435-4-T
5.0	2435-5-T
6.0	2435-6-T

Porte-outils pour machines Tornos DECO 13 / EvoDECO 16

Werkzeughalter für Tornos DECO 13 / EvoDECO 16 Maschinen

Tool holders for Tornos DECO 13 / EvoDECO 16 machines

2436 / 2436T

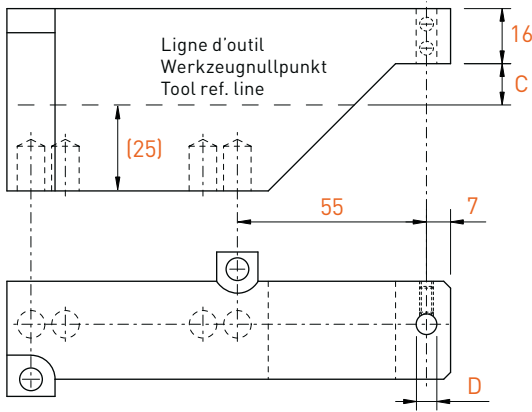

C	D	Art. N°
12	3.0	2436-12-3
12	4.0	2436-12-4
12	5.0	2436-12-5
12	6.0	2436-12-6
12	8.0	2436-12-8
18	3.0	2436-18-3
18	4.0	2436-18-4
18	5.0	2436-18-5
18	6.0	2436-18-6
18	8.0	2436-18-8

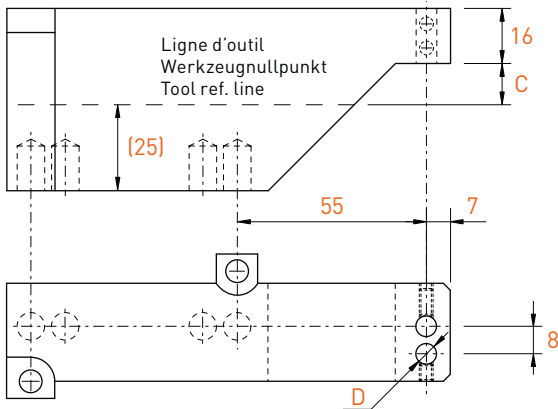

C	D (2x)	Art. N°
12	3.0	2436T-12-3
12	4.0	2436T-12-4
12	5.0	2436T-12-5
12	6.0	2436T-12-6
18	3.0	2436T-18-3
18	4.0	2436T-18-4
18	5.0	2436T-18-5
18	6.0	2436T-18-6

Entretroise

Erhöhungplatte

Spacer

2436-S12

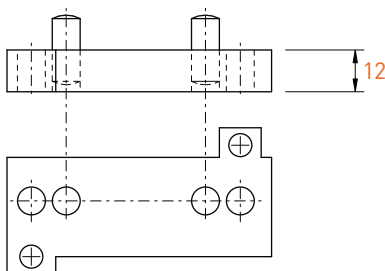

Art. N°

2436-S12

TOOLING-LINE

Forets à centrer plats

Zentrierflachbohrer

Centering flat drills

90°

1200 / 2200

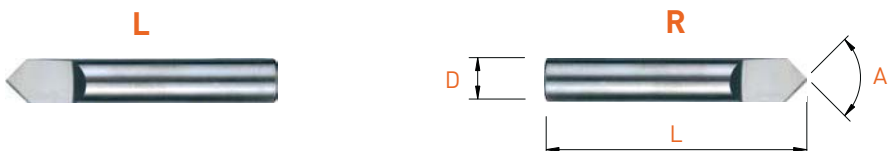

MD VHM HM			L	R
A	D	L	Art. N°	Art. N°
90°	3	17	1200-317	2200-317
90°	3	38	1200-338	2200-338
90°	4	40	1200-440	2200-440
90°	5	50	1200-550	2200-550
90°	6	50	1200-650	2200-650
90°	8	58	1200-858	2200-858
90°	10	66	1200-1066	2200-1066
90°	12	73	1200-1273	2200-1273

Forets à centrer hélicoïdaux

Zentrierspiralbohrer

Centering twist drills

90°

1500 / 2520

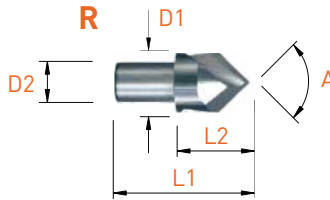

A	D1	D2	L1	L2	HSS		MD / VHM / HM	
					L	R	L	R
90°	5	4	17	8	Art. N°	Art. N°	Art. N°	Art. N°
90°	5	4	17	8	1500-5-HSS	2520-5-HSS	1500-5	2520-5
90°	7	5	17	8	1500-7-HSS	2520-7-HSS	1500-7	2520-7
90°	10	6	22	10	1500-10-HSS	2520-10-HSS	1500-10	2520-10
90°	12	8	26	12	1500-12-HSS	2520-12-HSS	1500-12	2520-12

Forets à centrer hélicoïdaux

Zentrierspiralbohrer

Centering twist drills

120°

1510 / 2530

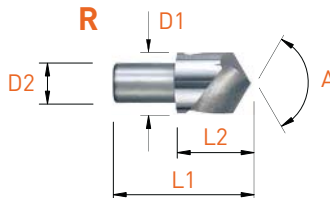

A	D1	D2	L1	L2	MD VHM HM	
					L	R
120°	5	4	17	8	Art. N°	Art. N°
120°	5	4	17	8	1510-5	2530-5
120°	7	5	17	8	1510-7	2530-7
120°	10	6	22	10	1510-10	2530-10
120°	12	8	26	12	1510-12	2530-12

TOOLING-LINE

Burins intérieurs en métal dur
 Vollhartmetall Innendrehwerkzeuge
 Solid carbide internal turning tools

1600 / 2620

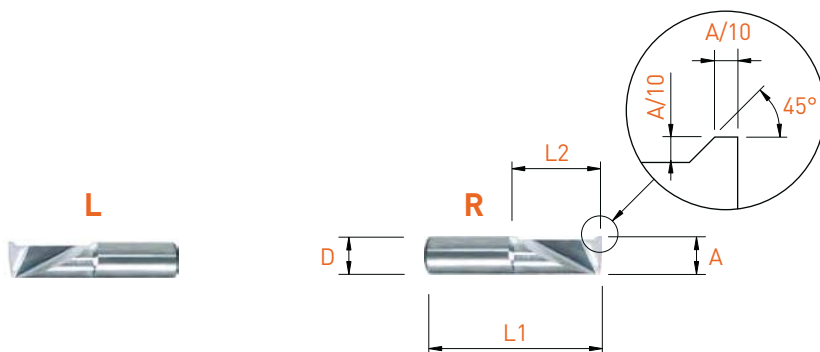

				L	R
MD VHM HM				Art. N°	Art. N°
A -0.05	D	L1	L2	Art. N°	Art. N°
2	3	13	4	1600-2-4	2620-2-4
3	3	15	6	1600-3-6	2620-3-6
4	4	17	8	1600-4-8	2620-4-8
4	4	21	12	1600-4-12	2620-4-12
5	5	21	10	1600-5-10	2620-5-10
5	5	26	15	1600-5-15	2620-5-15
6	6	25	12	1600-6-12	2620-6-12
6	6	31	18	1600-6-18	2620-6-18
8	8	32	16	1600-8-16	2620-8-16
8	8	40	24	1600-8-24	2620-8-24

Burins intérieurs en métal dur
 Vollhartmetall Innendrehwerkzeuge
 Solid carbide internal turning tools

1610 / 2630

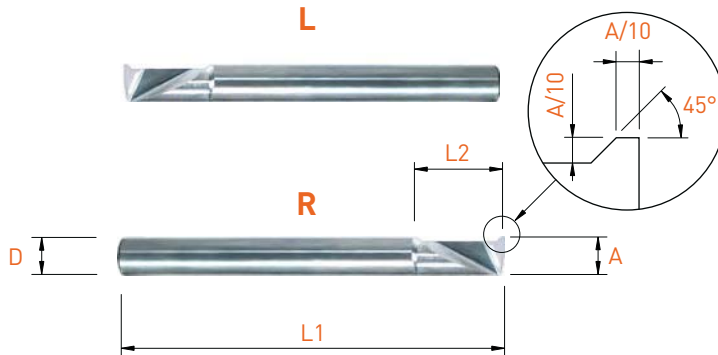

MD VHM HM				L	R
A -0.05	D	L1	L2	Art. N°	Art. N°
2	3	38	4	1610-2-4	2630-2-4
3	3	38	6	1610-3-6	2630-3-6
4	4	40	8	1610-4-8	2630-4-8
4	4	40	12	1610-4-12	2630-4-12
5	5	50	10	1610-5-10	2630-5-10
5	5	54	15	1610-5-15	2630-5-15
6	6	50	12	1610-6-12	2630-6-12
6	6	57	18	1610-6-18	2630-6-18
8	8	58	16	1610-8-16	2630-8-16
8	8	63	24	1610-8-24	2630-8-24
10	10	72	30	-	2630-10-30
12	12	83	36	-	2630-12-36

Porte-molettes

Rändelhalter

Knurl holders

1402 / 2402

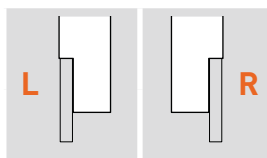
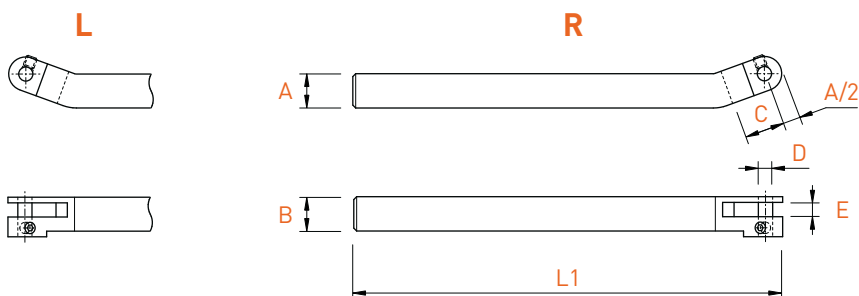

Pièces de rechange
Ersatzteile
Spare parts



A x B	L	E	D	C	A/2	Art. N°	Art. N°	Art. N°
6 x 6	132	2	3	10	3	1402-623	2402-623	GP-Ø3X10-A6H2.5
6 x 6	132	3	3	10	3	1402-633	2402-633	GP-Ø3X10-A6H2.5
7 x 7	140	2	3	10	3.5	1402-723	2402-723	GP-Ø3X12-A6H2.5
7 x 7	140	3	3	10	3.5	1402-733	2402-733	GP-Ø3X12-A6H2.5
7 x 7	140	4	3	10	3.5	1402-743	2402-743	GP-Ø3X12-A6H2.5
7 x 7	140	2	4	10	3.5	1402-724	2402-724	GP-Ø4X12-A6H3.5
7 x 7	140	3	4	10	3.5	1402-734	2402-734	GP-Ø4X12-A6H3.5
7 x 7	140	4	4	10	3.5	1402-744	2402-744	GP-Ø4X12-A6H3.5
8 x 8	140	2	3	10	4	1402-823	2402-823	GP-Ø3X12-A6H2.5
8 x 8	140	3	3	10	4	1402-833	2402-833	GP-Ø3X12-A6H2.5
8 x 8	140	4	3	10	4	1402-843	2402-843	GP-Ø3X12-A6H2.5
8 x 8	140	2	4	10	4	1402-824	2402-824	GP-Ø4X12-A6H3.5
8 x 8	140	3	4	10	4	1402-834	2402-834	GP-Ø4X12-A6H3.5
8 x 8	140	4	4	10	4	1402-844	2402-844	GP-Ø4X12-A6H3.5
10 x 10	150	3	3	10	5	1402-1033	2402-1033	GP-Ø3X14-A8H2.5
10 x 10	150	4	3	10	5	1402-1043	2402-1043	GP-Ø3X14-A8H2.5
10 x 10	150	3	4	10	5	1402-1034	2402-1034	GP-Ø4X14-A8H3.5
10 x 10	150	4	4	10	5	1402-1044	2402-1044	GP-Ø4X14-A8H3.5
10 x 10	150	5	4	10	5	1402-1054	-	GP-Ø4X14-A8H3.5
12 x 12	150	4	4	12	6	1402-1244	2402-1244	GP-Ø4X14-A8H3.5
12 x 12	150	5	4	12	6	1402-1254	2402-1254	GP-Ø4X14-A8H3.5
12 x 12	150	4	5	12	6	1402-1245	2402-1245	GP-Ø5X14-A8H4.5
12 x 12	150	5	5	12	6	1402-1255	2402-1255	GP-Ø5X14-A8H4.5
16 x 16	150	4	4	12	8	1402-1644	2402-1644	GP-Ø4X16-A8H3.5
16 x 16	150	4	5	12	8	-	2402-1645	GP-Ø5X16-A9H4.5
16 x 16	150	5	5	12	8	-	2402-1655	GP-Ø5X16-A9H4.5
16 x 16	150	6	4	12	8	-	2402-1664	GP-Ø4X16-A8H3.5
16 x 16	150	6	6	12	8	-	2402-1666	GP-Ø6X16-A9H5.5
16 x 16	150	8	6	12	8	-	2402-1686	GP-Ø6X16-A9H5.5

* livré avec chaque porte-outil / mit jedem Halter geliefert / delivered with each holder

Molettes en métal dur

Vollhartmetall Rändelrädchen

Solid carbide knurling wheels

1107

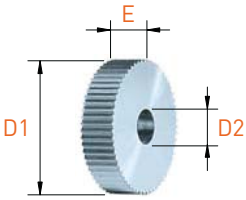

AA



BL

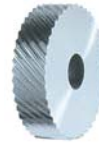

BR



GE

Molettes standards Standard Rändelrädchen Standard knurls	D1	E	D2	Pas (tous les 0.1 mm) Teilung (alle 0.1 mm) Pitch (every 0.1 mm)	
AA (0°)	8	2	3	0.2 - 0.6	
	8	2	4	0.2 - 0.6	
	8	3	3	0.2 - 0.6	
	8	3	4	0.2 - 0.6	
	8	4	3	0.2 - 0.6	
	8	4	4	0.2 - 0.6	
	10	2	3	0.2 - 0.8	
	10	2	4	0.2 - 0.8	
	10	3	3	0.2 - 0.8	
	BL 15° / BR 15° BL 30° / BR 30° BL 45° / BR 45°	10	3	4	0.2 - 0.8
		10	4	3	0.2 - 0.8
		10	4	4	0.2 - 0.8
		10	4	4	0.2 - 0.8
	GE 30° GE 45°	12	4	4	0.3 - 1.0
		15	4	4	0.4 - 1.0
		15	4	5	0.4 - 1.0
15		5	4	0.4 - 1.0	
15		5	5	0.4 - 1.0	
20		4	5	0.5 - 1.2	
20		5	5	0.5 - 1.2	
20		6	6	0.5 - 1.2	
20	8	6	0.5 - 1.2		

Molettes "Quick" "Quick"-Rändelrädchen "Quick"-knurling wheels	D1	E	D2	Pas (tous les 0.1 mm) Teilung (alle 0.1 mm) Pitch (every 0.1 mm)
AA (0°)	8.9	2.5	4	0.2 - 0.8
BL 15° / BR 15°	14.5	3	5	0.4 - 1.0
BL 30° / BR 30°	21.5	5	8	0.5 - 1.2

Exécutions spéciales sur demande
Sonderausführungen auf Anfrage
Special executions on request

Nouveautés présentées dans ce catalogue
 Neuheiten dieses Kataloges
 New products introduced in this catalogue



APPLITEC

Outil Werkzeug Tool	Type Typ Type	Page Seite Page
Micro-fraises Mikropräzisionsfräser Micro end mills	3271-1	13.10
	3278-1	13.31
Fraises ébauches Schruppfräser Roughing mills	E-DHP3300	13.35
	E-DHP3400	
Fraises en bout de finition Schlicht Schafftfräser Finishing end mills	701S3371	13.56

Dimensions supplémentaires Zusätzliche Abmessungen Additional dimensions		
Outil Werkzeug Tool	∅	Page Seite Page
3170-2	2.10	13.05
	2.20	
	2.30	
	2.40	
	2.60	
	2.70	
	2.80	
3170R-3	0.20	13.07
	0.35	
3271-3	0.65	13.13
	0.95	
	1.05	
	1.15	
	1.35	
	1.45	
	1.55	
	1.65	
	1.75	
	1.85	
	1.95	
3271-5	0.35	13.14
	0.55	
	0.65	
	0.75	
	0.85	
3371-1.3	0.35	13.16
	2.05	
3371-2	0.35	13.17
	0.45	
	0.95	

3371-3	0.45	13.18
	0.55	
	0.65	
	0.85	
	0.95	
	1.05	
	1.15	
	1.25	
	1.35	
	1.45	
3371-8	1.65	13.21
	1.85	
3471-3	1.95	13.26
	1.30	
	0.55	
3278-0.75	0.75	13.30
	0.85	
	0.95	
	0.70	
	0.90	
3278-1.50	1.50	13.32
	2.00	
	2.50	
	0.85	
	1.15	
	1.70	
	1.90	
	2.10	
	2.20	
	2.30	
	2.40	
2.60		
3278-3	2.70	13.33
	1.30	
	1.55	
	2.60	
	2.70	

Outil Werkzeug Tool	Type Typ Type	Page Seite Page
E300-P	E320P	13.61
E300-R	E320R	13.62
E900-P	E920-P	13.63

Index

Micro-fraises de précision
Mikropräzisionsfräser
Precision micro end mills

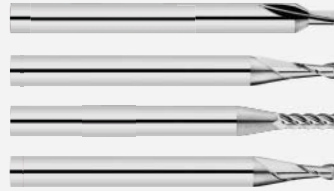

> 13.03

Fraises ébauches
Schruppfräser
Roughing mills



> 13.34

Fraises en bout de finition
Schlicht Schaftfräser
Finishing end mills



> 13.36

Fraises à graver
Gravierfräser
Engraving mills



> 13.60

Micro-forets et centreurs
Mikrobohrer und Zentrierbohrer
Micro drills and centering drills



> 13.64

N

Non revêtu
Unbeschichtet
Uncoated

- acuité d'arête maximale grâce à une finition super polie de l'outil
- premier choix pour les outils de très petits diamètres (< Ø 0.5 mm)
- premier choix pour l'usinage du laiton et de l'aluminium faiblement allié

- maximale Schärfe der Schneidkante durch hochpolierte Fertigung
- für Werkzeuge mit sehr kleiner Durchmesser (< Ø 0.5 mm) bestens geeignet
- für die Bearbeitung von Messing und niedrig legiertes Aluminium bestens geeignet

- highest sharpness of the cutting edge through high polished finishing
- first choice for tools with very small diameter (< Ø 0.5 mm)
- first choice for brass and low alloyed aluminium machining

TiAlN

Revêtement PVD à couche mince
Dünnschicht PVD Beschichtung
Thin PVD coating

- excellente nuance universelle
- très bonne résistance à la température
- premier choix pour l'usinage des aciers, aciers inoxydables et titane fortement allié

- beste Universalsorte
- sehr gute Warmfestigkeit
- für die Bearbeitung von Stahl, rostfreiem Stahl und hochlegiertem Titan bestens geeignet

- best universal grade
- very good heat resistance
- first choice for steel, stainless steel and high alloyed titanium machining

TiCN

Revêtement PVD à couche mince
Dünnschicht PVD Beschichtung
Thin PVD coating

- excellente nuance pour les outils de petits diamètres
- très faible coefficient de frottement
- premier choix pour l'usinage des matières qui créent des arêtes rapportées

- sehr gute Sorte für Werkzeuge mit sehr kleiner Durchmesser
- sehr geringer Reibwert
- beste Sorte für die Bearbeitung von Werkstoffen mit Tendenz zur Bildung von Aufbauschneide

- very good grade for tools with very small diameter
- very low friction ratio
- first choice for the machining of materials which causes edge build-up

DLC53

Revêtement DLC à couche mince
Dünnschicht DLC Beschichtung
Thin DLC coating

- excellente nuance pour l'usinage des métaux non ferreux tels que des alliages d'aluminium et de cuivre, laiton sans plomb, des métaux précieux, ainsi que des graphites et polymères
- très faible coefficient de frottement
- très haute résistance à l'usure grâce à une dureté de revêtement très élevée

- sehr gute Sorte für die Bearbeitung von Nichteisenmetalle wie Aluminium und Kupfer Legierungen, bleifreies Messing, sowie für Graphit und Polymer
- sehr geringer Reibwert
- sehr Verschleissfest durch sehr hohe Beschichtungshärte

- very good grade for the machining of non-ferrous materials like aluminium and copper alloys, lead-free brass, precious metals, as well as graphite and polymer
- very low friction ratio through extremely hard coating

Micro-fraises de précision

Mikropräzisionsfräser



Precision micro end mills

Paramètres de coupe indicatifs

Empfohlene Schnittwerte

Standard machining data

Matière Werkstoff Material	Lubrifiant Kühlung Coolant	VC (m/min)	fz									Non revêtu Unbeschichtet Uncoated	Revêtu Beschichtet Coated
			Ø1.0	Ø2.0	Ø3.0	Ø4.0	Ø5.0	Ø6.0	Ø8.0	Ø10.0			
Acier Stahl Steel < 700 N/mm ² P	O/E	120	0.015	0.02	0.02	0.03	0.03	0.04	0.04	0.045	-	++	
Acier Stahl Steel > 700 N/mm ² P	O/E	100	0.01	0.015	0.015	0.02	0.025	0.03	0.035	0.04	-	++	
Fonte Gusseisen Cast iron K	O/E	130	0.015	0.02	0.025	0.035	0.035	0.045	0.05	0.06	-	++	
Acier inoxydable Rostfreistahl Stainless steel M	O/E	100	0.004	0.008	0.01	0.015	0.02	0.025	0.03	0.04	-	++	
Aluminium N	O/E	300	0.02	0.03	0.03	0.045	0.05	0.06	0.075	0.09	+	++	
Cuivre, laiton, bronze Kupfer, Messing, Bronze Copper, brass, bronze N	O/E	160	0.008	0.015	0.025	0.03	0.03	0.04	0.06	0.07	+	++	
Métaux précieux Edelmetalle Precious metals N	O/E	180	0.008	0.015	0.025	0.03	0.03	0.04	0.06	0.07	+	++	
Titane Titan Titanium S	O/E	60	0.007	0.01	0.015	0.015	0.02	0.025	0.03	0.04	++	+	

Sharp Corner	Micro-fraises avec angles vifs Mikropräzisionsfräser mit scharfkantigen Ecken Micro end mills with sharp corners						
	Z	Helix	L2	Range	Shank	Type	page
	Z = 1	0°	2 x D1	Ø 0.20 - 3.00	Ø 3h4 (Ø4)	3170-2	13.05
			2 x D1	Ø 0.20 - 3.00	Ø 3h4 (Ø4)	3170R-2	13.06
			3 x D1	Ø 0.20 - 3.00	Ø 3h4 (Ø4)	3170R-3	13.07
			4 x D1	Ø 0.20 - 3.00	Ø 3h4 (Ø4)	3170R-4	13.08
	Z = 2	30°	0.75 x D1	Ø 0.20 - 2.00	Ø 3h4	3271-0.75	13.09
			1 x D1	Ø 0.10 - 2.00	Ø 3h4	3271-1	13.10
			1.5 x D1	Ø 0.10 - 2.00	Ø 3h4	3271-1.5	13.11
			2 x D1	Ø 0.10 - 2.00	Ø 3h4	3271-2	13.12
			3 x D1	Ø 0.10 - 2.90	Ø 3h4	3271-3	13.13
			5 x D1	Ø 0.30 - 2.50	Ø 3h4	3271-5	13.14
			8 x D1	Ø 0.40 - 2.50	Ø 3h4 (Ø4)	3271-8	13.15
	Z = 3	30°	1.3 x D1	Ø 0.30 - 2.90	Ø 3h4	3371-1.3	13.16
			2 x D1	Ø 0.30 - 2.90	Ø 3h4	3371-2	13.17
			3 x D1	Ø 0.30 - 2.90	Ø 3h4	3371-3	13.18
			4 x D1	Ø 0.30 - 2.90	Ø 3h4	3371-4	13.19
		36°/38°/40°	5 x D1	Ø 0.50 - 2.50	Ø 3h4	3371-5	13.20
			8 x D1	Ø 0.50 - 2.50	Ø 3h4 (Ø4)	3371-8	13.21
			1.5 x D1	Ø 0.30 - 2.50	Ø 3h4	DHD3371-1.5	13.22
			3 x D1	Ø 0.30 - 2.50	Ø 3h4	DHD3371-3	13.23
45°	2.5 x D1	Ø 0.30 - 2.90	Ø 3h4	3375-2.5	13.24		
	1.5 x D1	Ø 0.30 - 2.90	Ø 3h4	3471-1.5	13.25		
Z = 4	30°	3 x D1	Ø 0.30 - 2.90	Ø 3h4	3471-3	13.26	
		35° - 38°	3 x D1	Ø 0.50 - 2.50	Ø 3h4	DHP3471-3	13.27
	40°	2 x D1	Ø 0.30 - 2.90	Ø 3h4	3472-2	13.28	
		4 x D1	Ø 0.40 - 2.90	Ø 3h4	3472-4	13.29	

U	Micro-fraises hémisphériques Vollradius Mikropräzisionsfräser Ball nose micro end mills						
	Z	Helix	L2	Range	Shank	Type	page
	Z = 2	30°	0.75 x D1	Ø 0.20 - 1.00	Ø 3h4	3278-0.75	13.30
			1 x D1	Ø 0.20 - 2.50	Ø 3h4	3278-1	13.31
			1.5 x D1	Ø 0.20 - 2.50	Ø 3h4	3278-1.5	13.32
			3 x D1	Ø 0.20 - 2.90	Ø 3h4	3278-3	13.33

Micro-fraises de précision

Mikropräzisionsfräser

Precision micro end mills

3170-2

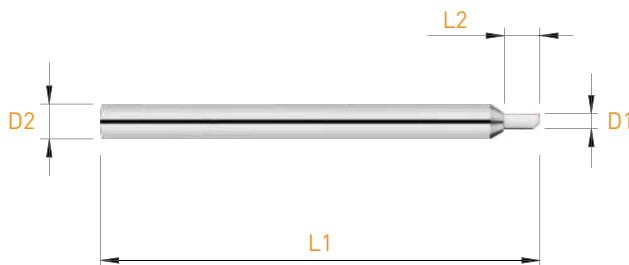

D1 +0.005 / -0.010	L2	D2 h4	L1	Art. N°	Z	TiAIN	TiCN	DLC53
0.20	0.40	3.00	39	3170-2-0.20	■			
0.30	0.60	3.00	39	3170-2-0.30	■	□	□	■
0.40	0.80	3.00	39	3170-2-0.40	■	□	□	■
0.50	1.00	3.00	39	3170-2-0.50	■	□	□	■
0.60	1.20	3.00	39	3170-2-0.60	■	□	□	■
0.70	1.40	3.00	39	3170-2-0.70	■	□	□	■
0.80	1.60	3.00	39	3170-2-0.80	■	□	□	■
0.90	1.80	3.00	39	3170-2-0.90	■	□	□	■
1.00	2.00	3.00	39	3170-2-1.00	■	□	□	■
1.10	2.20	3.00	39	3170-2-1.10	■	□	□	■
1.20	2.40	3.00	39	3170-2-1.20	■	□	□	■
1.30	2.60	3.00	39	3170-2-1.30	■	□	□	■
1.40	2.80	3.00	39	3170-2-1.40	■	□	□	■
1.50	3.00	3.00	39	3170-2-1.50	■	□	□	■
1.60	3.20	3.00	39	3170-2-1.60	■	□	□	■
1.70	3.40	3.00	39	3170-2-1.70	■	□	□	■
1.80	3.60	3.00	39	3170-2-1.80	■	□	□	■
1.90	3.80	3.00	39	3170-2-1.90	■	□	□	■
2.00	4.00	3.00	39	3170-2-2.00	■	□	□	■
2.10	4.20	3.00	39	3170-2-2.10	■	□	□	■
2.20	4.40	3.00	39	3170-2-2.20	■	□	□	■
2.30	4.60	3.00	39	3170-2-2.30	■	□	□	■
2.40	4.80	3.00	39	3170-2-2.40	■	□	□	■
2.50	5.00	3.00	39	3170-2-2.50	■	□	□	■
2.60	5.20	3.00	39	3170-2-2.60	■	□	□	■
2.70	5.40	3.00	39	3170-2-2.70	■	□	□	■
2.80	5.60	3.00	39	3170-2-2.80	■	□	□	■
2.90	5.80	3.00	39	3170-2-2.90	■	□	□	■
3.00	6.00	4.00*	40	3170-2-3.00	■	□	□	■

* = h6

■ = disponible / verfügbar / available

□ = selon disponibilité du stock / jenach Lagerverfügbarkeit / depending on stock availability

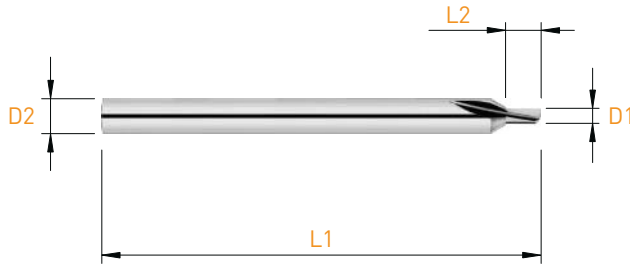

D1 +0.005 / -0.010	L2	D2 h4	L1	Art. N°	Z	TiAIN	TiCN	DLC53
0.20	0.40	3.00	39	3170R-2-0.20	■			
0.30	0.60	3.00	39	3170R-2-0.30	■	□	□	■
0.40	0.80	3.00	39	3170R-2-0.40	■	□	□	■
0.50	1.00	3.00	39	3170R-2-0.50	■	□	□	■
0.60	1.20	3.00	39	3170R-2-0.60	■	□	□	■
0.70	1.40	3.00	39	3170R-2-0.70	■	□	□	■
0.80	1.60	3.00	39	3170R-2-0.80	■	□	□	■
0.90	1.80	3.00	39	3170R-2-0.90	■	□	□	■
1.00	2.00	3.00	39	3170R-2-1.00	■	□	□	■
1.10	2.20	3.00	39	3170R-2-1.10	■	□	□	■
1.20	2.40	3.00	39	3170R-2-1.20	■	□	□	■
1.30	2.60	3.00	39	3170R-2-1.30	■	□	□	■
1.40	2.80	3.00	39	3170R-2-1.40	■	□	□	■
1.50	3.00	3.00	39	3170R-2-1.50	■	□	□	■
1.60	3.20	3.00	39	3170R-2-1.60	■	□	□	■
1.70	3.40	3.00	39	3170R-2-1.70	■	□	□	■
1.80	3.60	3.00	39	3170R-2-1.80	■	□	□	■
1.90	3.80	3.00	39	3170R-2-1.90	■	□	□	■
2.00	4.00	3.00	39	3170R-2-2.00	■	□	□	■
2.10	4.10	3.00	39	3170R-2-2.10	■	□	□	■
2.20	4.40	3.00	39	3170R-2-2.20	■	□	□	■
2.30	4.60	3.00	39	3170R-2-2.30	■	□	□	■
2.40	4.80	3.00	39	3170R-2-2.40	■	□	□	■
2.50	5.00	3.00	39	3170R-2-2.50	■	□	□	■
2.60	5.20	3.00	39	3170R-2-2.60	■	□	□	■
2.70	5.40	3.00	39	3170R-2-2.70	■	□	□	■
2.80	5.60	3.00	39	3170R-2-2.80	■	□	□	■
2.90	5.80	3.00	39	3170R-2-2.90	■	□	□	■
3.00	6.00	4.00*	40	3170R-2-3.00	■	□	□	■

* = h6

Micro-fraises de précision

Mikropräzisionsfräser

Precision micro end mills

3170R-3

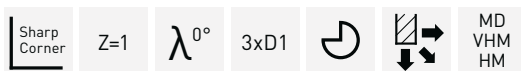
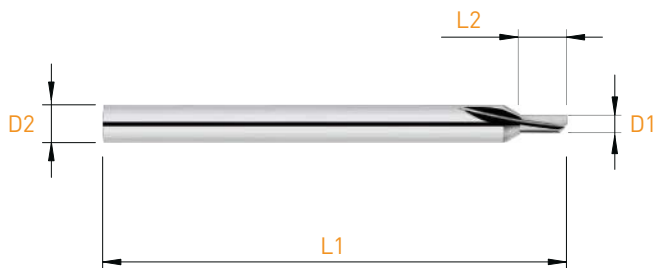

D1 +0.005 / -0.010	L2	D2 h4	L1	Art. N°	Z	TiAIN	TiCN	DLC53
0.20	0.60	3.00	39	3170R-3-0.20	■			
0.30	0.90	3.00	39	3170R-3-0.30	■	□	□	■
0.40	1.20	3.00	39	3170R-3-0.40	■	□	□	■
0.50	1.50	3.00	39	3170R-3-0.50	■	□	□	■
0.60	1.80	3.00	39	3170R-3-0.60	■	□	□	■
0.70	2.10	3.00	39	3170R-3-0.70	■	□	□	■
0.80	2.40	3.00	39	3170R-3-0.80	■	□	□	■
0.90	2.70	3.00	39	3170R-3-0.90	■	□	□	■
1.00	3.00	3.00	39	3170R-3-1.00	■	□	□	■
1.10	3.30	3.00	39	3170R-3-1.10	■	□	□	■
1.20	3.60	3.00	39	3170R-3-1.20	■	□	□	■
1.30	3.90	3.00	39	3170R-3-1.30	■	□	□	■
1.40	4.20	3.00	39	3170R-3-1.40	■	□	□	■
1.50	4.50	3.00	39	3170R-3-1.50	■	□	□	■
2.00	6.00	3.00	39	3170R-3-2.00	■	□	□	■
2.50	7.50	3.00	39	3170R-3-2.50	■	□	□	■
3.00	9.00	4.00*	40	3170R-3-3.00	■	□	□	■

* = h6

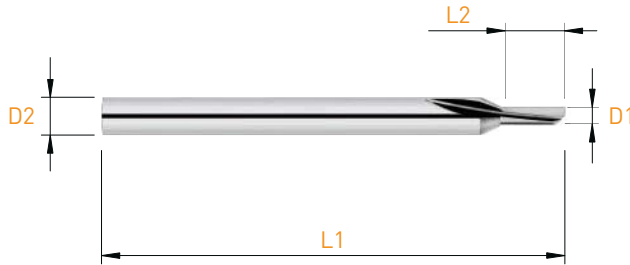

D1 +0.005 / -0.010	L2	D2 h4	L1	Art. N°	Z	TiAIN	TiCN	DLC53
0.30	1.20	3.00	39	3170R-4-0.30	■	□	□	■
0.40	1.60	3.00	39	3170R-4-0.40	■	□	□	■
0.50	2.00	3.00	39	3170R-4-0.50	■	□	□	■
0.60	2.40	3.00	39	3170R-4-0.60	■	□	□	■
0.70	2.80	3.00	39	3170R-4-0.70	■	□	□	■
0.80	3.20	3.00	39	3170R-4-0.80	■	□	□	■
0.90	3.60	3.00	39	3170R-4-0.90	■	□	□	■
1.00	4.00	3.00	39	3170R-4-1.00	■	□	□	■
1.10	4.40	3.00	39	3170R-4-1.10	■	□	□	■
1.20	4.80	3.00	39	3170R-4-1.20	■	□	□	■
1.30	5.20	3.00	39	3170R-4-1.30	■	□	□	■
1.40	5.60	3.00	39	3170R-4-1.40	■	□	□	■
1.50	6.00	3.00	39	3170R-4-1.50	■	□	□	■
2.00	8.00	3.00	39	3170R-4-2.00	■	□	□	■
2.50	10.00	3.00	39	3170R-4-2.50	■	□	□	■
3.00	12.00	4.00*	40	3170R-4-3.00	■	□	□	■

* = h6

Micro-fraises de précision

Mikropräzisionsfräser

Precision micro end mills

3271-0.75

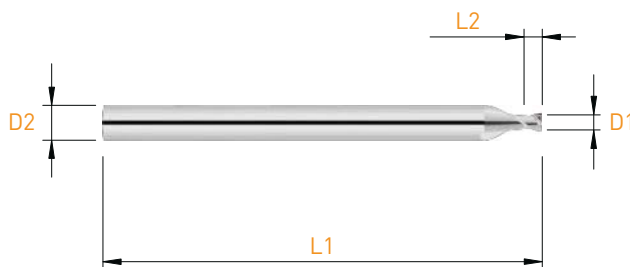

D1 +0.005 / -0.010	L2	D2 h4	L1	Art. N°	Z	TiAIN	TiCN	DLC53
0.20	0.15	3.00	39	3271-0.75-0.20	■			
0.30	0.25	3.00	39	3271-0.75-0.30	■	■	■	■
0.40	0.30	3.00	39	3271-0.75-0.40	■	■	■	■
0.50	0.37	3.00	39	3271-0.75-0.50	■	■	■	■
0.60	0.45	3.00	39	3271-0.75-0.60	■	■	■	■
0.70	0.53	3.00	39	3271-0.75-0.70	■	■	■	■
0.80	0.60	3.00	39	3271-0.75-0.80	■	■	■	■
0.90	0.70	3.00	39	3271-0.75-0.90	■	■	■	■
1.00	0.75	3.00	39	3271-0.75-1.00	■	■	■	■
1.10	0.90	3.00	39	3271-0.75-1.10	■	■	■	■
1.20	0.90	3.00	39	3271-0.75-1.20	■	■	■	■
1.30	1.00	3.00	39	3271-0.75-1.30	■	■	■	■
1.40	1.10	3.00	39	3271-0.75-1.40	■	■	■	■
1.50	1.15	3.00	39	3271-0.75-1.50	■	■	■	■
1.60	1.20	3.00	39	3271-0.75-1.60	■	■	■	■
1.70	1.30	3.00	39	3271-0.75-1.70	■	■	■	■
1.80	1.40	3.00	39	3271-0.75-1.80	■	■	■	■
1.90	1.45	3.00	39	3271-0.75-1.90	■	■	■	■
2.00	1.50	3.00	39	3271-0.75-2.00	■	■	■	■

MICRO-LINE

Micro-fraises de précision

Mikropräzisionsfräser

Precision micro end mills

3271-1

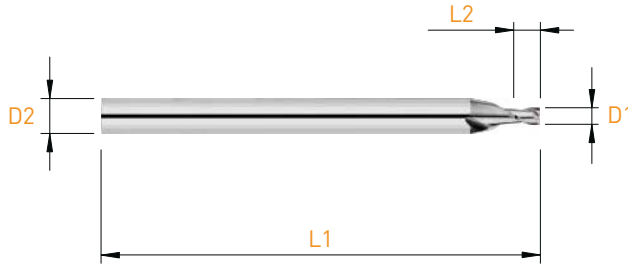

D1 +0.005 / -0.010	L2	D2 h4	L1	Art. N°	Z	TiAIN	TiCN	DLC53
0.30	0.30	3.00	39	3271-1-0.30	■	■	■	■
0.40	0.40	3.00	39	3271-1-0.40	■	■	■	■
0.50	0.50	3.00	39	3271-1-0.50	■	■	■	■
0.60	0.60	3.00	39	3271-1-0.60	■	■	■	■
0.70	0.70	3.00	39	3271-1-0.70	■	■	■	■
0.80	0.80	3.00	39	3271-1-0.80	■	■	■	■
0.90	0.90	3.00	39	3271-1-0.90	■	■	■	■
1.00	1.00	3.00	39	3271-1-1.00	■	■	■	■
1.10	1.10	3.00	39	3271-1-1.10	■	■	■	■
1.20	1.20	3.00	39	3271-1-1.20	■	■	■	■
1.30	1.30	3.00	39	3271-1-1.30	■	■	■	■
1.40	1.40	3.00	39	3271-1-1.40	■	■	■	■
1.50	1.50	3.00	39	3271-1-1.50	■	■	■	■
1.60	1.60	3.00	39	3271-1-1.60	■	■	■	■
1.70	1.70	3.00	39	3271-1-1.70	■	■	■	■
1.80	1.80	3.00	39	3271-1-1.80	■	■	■	■
1.90	1.90	3.00	39	3271-1-1.90	■	■	■	■
2.00	2.00	3.00	39	3271-1-2.00	■	■	■	■
2.50	2.50	3.00	39	3271-1-2.50	■	■	■	■

Micro-fraises de précision

Mikropräzisionsfräser

Precision micro end mills

3271-1.5

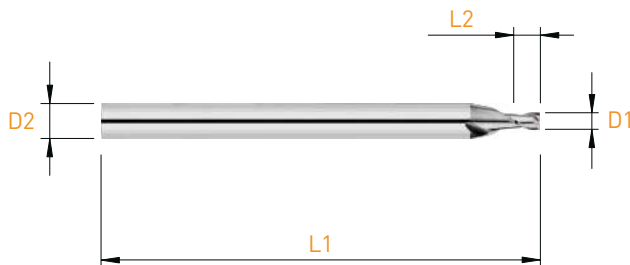

Sharp Corner Z=2 $\lambda 30^\circ$ 1.5xD1 MD VHM HM

D1 +0.005 / -0.010	L2	D2 h4	L1	Art. N°	Z	TiAIN	TiCN	DLC53
0.10	0.15	3.00	39	3271-1.5-0.10	■			
0.15	0.20	3.00	39	3271-1.5-0.15	■			
0.20	0.30	3.00	39	3271-1.5-0.20	■			
0.25	0.35	3.00	39	3271-1.5-0.25	■			
0.30	0.45	3.00	39	3271-1.5-0.30	■	■	■	■
0.40	0.60	3.00	39	3271-1.5-0.40	■	■	■	■
0.45	0.70	3.00	39	3271-1.5-0.45	■	■	■	■
0.50	0.75	3.00	39	3271-1.5-0.50	■	■	■	■
0.60	0.90	3.00	39	3271-1.5-0.60	■	■	■	■
0.70	1.05	3.00	39	3271-1.5-0.70	■	■	■	■
0.80	1.20	3.00	39	3271-1.5-0.80	■	■	■	■
0.90	1.35	3.00	39	3271-1.5-0.90	■	■	■	■
1.00	1.50	3.00	39	3271-1.5-1.00	■	■	■	■
1.10	1.65	3.00	39	3271-1.5-1.10	■	■	■	■
1.20	1.80	3.00	39	3271-1.5-1.20	■	■	■	■
1.30	1.95	3.00	39	3271-1.5-1.30	■	■	■	■
1.40	2.10	3.00	39	3271-1.5-1.40	■	■	■	■
1.50	2.25	3.00	39	3271-1.5-1.50	■	■	■	■
1.60	2.40	3.00	39	3271-1.5-1.60	■	■	■	■
1.70	2.55	3.00	39	3271-1.5-1.70	■	■	■	■
1.80	2.70	3.00	39	3271-1.5-1.80	■	■	■	■
1.90	2.85	3.00	39	3271-1.5-1.90	■	■	■	■
2.00	3.00	3.00	39	3271-1.5-2.00	■	■	■	■

MICRO-LINE

Micro-fraises de précision

Mikropräzisionsfräser

Precision micro end mills

3271-2

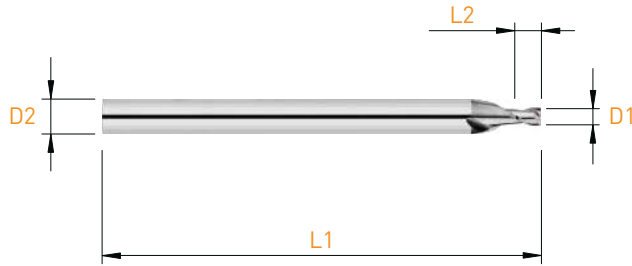

D1 +0.005 / -0.010	L2	D2 h4	L1	Art. N°	Z	TiAIN	TiCN	DLC53
0.10	0.20	3.00	39	3271-2-0.10	■			
0.15	0.30	3.00	39	3271-2-0.15	■			
0.20	0.40	3.00	39	3271-2-0.20	■			
0.25	0.50	3.00	39	3271-2-0.25	■			
0.30	0.60	3.00	39	3271-2-0.30	■	■	■	■
0.40	0.80	3.00	39	3271-2-0.40	■	■	■	■
0.50	1.00	3.00	39	3271-2-0.50	■	■	■	■
0.60	1.20	3.00	39	3271-2-0.60	■	■	■	■
0.70	1.40	3.00	39	3271-2-0.70	■	■	■	■
0.80	1.60	3.00	39	3271-2-0.80	■	■	■	■
0.90	1.80	3.00	39	3271-2-0.90	■	■	■	■
1.00	2.00	3.00	39	3271-2-1.00	■	■	■	■
1.10	2.20	3.00	39	3271-2-1.10	■	■	■	■
1.20	2.40	3.00	39	3271-2-1.20	■	■	■	■
1.30	2.60	3.00	39	3271-2-1.30	■	■	■	■
1.40	2.80	3.00	39	3271-2-1.40	■	■	■	■
1.50	3.00	3.00	39	3271-2-1.50	■	■	■	■
1.60	3.20	3.00	39	3271-2-1.60	■	■	■	■
1.70	3.40	3.00	39	3271-2-1.70	■	■	■	■
1.80	3.60	3.00	39	3271-2-1.80	■	■	■	■
1.90	3.80	3.00	39	3271-2-1.90	■	■	■	■
2.00	4.00	3.00	39	3271-2-2.00	■	■	■	■

Micro-fraises de précision

Mikropräzisionsfräser

Precision micro end mills

3271-3

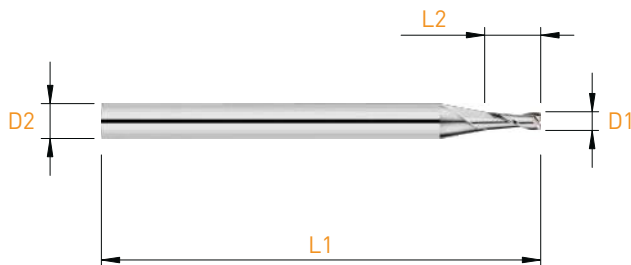

Sharp Corner Z=2 λ 30° 3xD1 MD VHM HM

D1 +0.005 / -0.010	L2	D2 h4	L1	Art. N°	Z	TiAlN TiCN DLC53
0.10	0.25	3.00	39	3271-3-0.10	■	
0.15	0.45	3.00	39	3271-3-0.15	■	
0.20	0.50	3.00	39	3271-3-0.20	■	
0.25	0.75	3.00	39	3271-3-0.25	■	
0.30	1.00	3.00	39	3271-3-0.30	■ ■ ■ ■	
0.35	1.10	3.00	39	3271-3-0.35	■ ■ ■ ■	
0.40	1.20	3.00	39	3271-3-0.40	■ ■ ■ ■	
0.50	1.50	3.00	39	3271-3-0.50	■ ■ ■ ■	
0.60	2.00	3.00	39	3271-3-0.60	■ ■ ■ ■	
0.65	2.00	3.00	39	3271-3-0.65	■ ■ ■ ■	
0.70	2.00	3.00	39	3271-3-0.70	■ ■ ■ ■	
0.75	2.00	3.00	39	3271-3-0.75	■ ■ ■ ■	
0.80	2.50	3.00	39	3271-3-0.80	■ ■ ■ ■	
0.90	2.50	3.00	39	3271-3-0.90	■ ■ ■ ■	
0.95	3.00	3.00	39	3271-3-0.95	■ ■ ■ ■	
1.00	3.00	3.00	39	3271-3-1.00	■ ■ ■ ■	
1.05	3.00	3.00	39	3271-3-1.05	■ ■ ■ ■	
1.10	3.00	3.00	39	3271-3-1.10	■ ■ ■ ■	
1.15	3.50	3.00	39	3271-3-1.15	■ ■ ■ ■	
1.20	4.00	3.00	39	3271-3-1.20	■ ■ ■ ■	
1.30	4.00	3.00	39	3271-3-1.30	■ ■ ■ ■	
1.35	4.00	3.00	39	3271-3-1.35	■ ■ ■ ■	
1.40	4.00	3.00	39	3271-3-1.40	■ ■ ■ ■	
1.45	4.40	3.00	39	3271-3-1.45	■ ■ ■ ■	
1.50	4.50	3.00	39	3271-3-1.50	■ ■ ■ ■	
1.55	4.50	3.00	39	3271-3-1.55	■ ■ ■ ■	
1.60	4.50	3.00	39	3271-3-1.60	■ ■ ■ ■	
1.65	5.00	3.00	39	3271-3-1.65	■ ■ ■ ■	
1.70	5.00	3.00	39	3271-3-1.70	■ ■ ■ ■	
1.75	5.30	3.00	39	3271-3-1.75	■ ■ ■ ■	

D1 +0.005 / -0.010	L2	D2 h4	L1	Art. N°	Z	TiAlN TiCN DLC53
1.80	6.00	3.00	39	3271-3-1.80	■ ■ ■ ■	
1.85	6.00	3.00	39	3271-3-1.85	■ ■ ■ ■	
1.90	6.00	3.00	39	3271-3-1.90	■ ■ ■ ■	
1.95	6.00	3.00	39	3271-3-1.95	■ ■ ■ ■	
2.00	6.00	3.00	39	3271-3-2.00	■ ■ ■ ■	
2.10	6.00	3.00	39	3271-3-2.10	■ ■ ■ ■	
2.20	6.50	3.00	39	3271-3-2.20	■ ■ ■ ■	
2.30	7.00	3.00	39	3271-3-2.30	■ ■ ■ ■	
2.40	7.00	3.00	39	3271-3-2.40	■ ■ ■ ■	
2.50	7.50	3.00	39	3271-3-2.50	■ ■ ■ ■	
2.60	7.50	3.00	39	3271-3-2.60	■ ■ ■ ■	
2.70	8.00	3.00	39	3271-3-2.70	■ ■ ■ ■	
2.80	8.00	3.00	39	3271-3-2.80	■ ■ ■ ■	
2.90	8.00	3.00	39	3271-3-2.90	■ ■ ■ ■	

MICRO-LINE

Micro-fraises de précision

Mikropräzisionsfräser

Precision micro end mills

3271-5

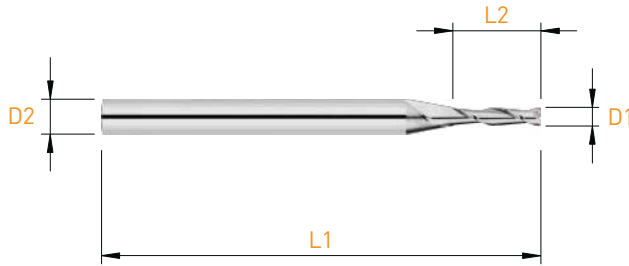

D1 +0.005 / -0.010	L2	D2 h4	L1	Art. N°	Z	TiAIN	TiCN	DLC53
0.30	1.50	3.00	39	3271-5-0.30	■	■	■	■
0.35	1.80	3.00	39	3271-5-0.35	■	■	■	■
0.40	2.00	3.00	39	3271-5-0.40	■	■	■	■
0.50	2.50	3.00	39	3271-5-0.50	■	■	■	■
0.55	2.80	3.00	39	3271-5-0.55	■	■	■	■
0.60	3.00	3.00	39	3271-5-0.60	■	■	■	■
0.65	3.30	3.00	39	3271-5-0.65	■	■	■	■
0.70	3.50	3.00	39	3271-5-0.70	■	■	■	■
0.75	3.80	3.00	39	3271-5-0.75	■	■	■	■
0.80	4.00	3.00	39	3271-5-0.80	■	■	■	■
0.85	4.30	3.00	39	3271-5-0.85	■	■	■	■
0.90	4.50	3.00	39	3271-5-0.90	■	■	■	■
0.95	4.80	3.00	39	3271-5-0.95	■	■	■	■
1.00	5.00	3.00	39	3271-5-1.00	■	■	■	■
1.10	5.50	3.00	39	3271-5-1.10	■	■	■	■
1.20	6.00	3.00	39	3271-5-1.20	■	■	■	■
1.50	7.50	3.00	39	3271-5-1.50	■	■	■	■
2.00	10.00	3.00	39	3271-5-2.00	■	■	■	■
2.50	12.50	3.00	39	3271-5-2.50	■	■	■	■

Micro-fraises de précision

Mikropräzisionsfräser

Precision micro end mills

3271-8

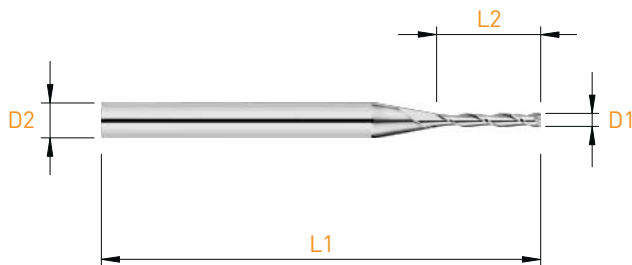

Sharp Corner Z=2 $\lambda 30^\circ$ 8xD1 MD VHM HM

D1 +0.005 / -0.010	L2	D2 h4	L1	Art. N°	Z	TiAIN	TiCN	DLC53
0.40	3.20	3.00	39	3271-8-0.40	■	■	■	■
0.50	4.00	3.00	39	3271-8-0.50	■	■	■	■
0.60	5.00	3.00	39	3271-8-0.60	■	■	■	■
0.70	5.60	3.00	39	3271-8-0.70	■	■	■	■
0.80	6.00	3.00	39	3271-8-0.80	■	■	■	■
0.90	7.20	3.00	39	3271-8-0.90	■	■	■	■
1.00	8.00	3.00	39	3271-8-1.00	■	■	■	■
1.20	9.00	3.00	39	3271-8-1.20	■	■	■	■
1.50	12.00	4.00*	50	3271-8-1.50	■	■	■	■
2.00	16.00	4.00*	50	3271-8-2.00	■	■	■	■
2.50	20.00	4.00*	50	3271-8-2.50	■	■	■	■

* = h6

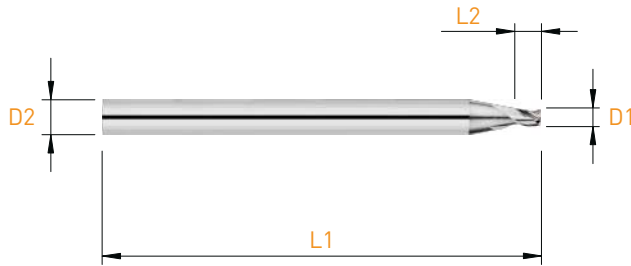

D1 +0.005 / -0.010	L2	D2 h4	L1	Art. N°	Z	TiAlN	TiCN	DLC53
0.30	0.40	3.00	39	3371-1.3-0.30	■	■	■	■
0.35	0.50	3.00	39	3371-1.3-0.35	■	■	■	■
0.40	0.50	3.00	39	3371-1.3-0.40	■	■	■	■
0.45	0.60	3.00	39	3371-1.3-0.45	■	■	■	■
0.50	0.70	3.00	39	3371-1.3-0.50	■	■	■	■
0.60	0.80	3.00	39	3371-1.3-0.60	■	■	■	■
0.70	0.90	3.00	39	3371-1.3-0.70	■	■	■	■
0.80	1.00	3.00	39	3371-1.3-0.80	■	■	■	■
0.90	1.30	3.00	39	3371-1.3-0.90	■	■	■	■
1.00	1.30	3.00	39	3371-1.3-1.00	■	■	■	■
1.10	1.50	3.00	39	3371-1.3-1.10	■	■	■	■
1.20	1.60	3.00	39	3371-1.3-1.20	■	■	■	■
1.30	1.80	3.00	39	3371-1.3-1.30	■	■	■	■
1.40	1.80	3.00	39	3371-1.3-1.40	■	■	■	■
1.50	2.00	3.00	39	3371-1.3-1.50	■	■	■	■
1.55	2.00	3.00	39	3371-1.3-1.55	■	■	■	■
1.60	2.00	3.00	39	3371-1.3-1.60	■	■	■	■
1.65	2.00	3.00	39	3371-1.3-1.65	■	■	■	■
1.70	2.00	3.00	39	3371-1.3-1.70	■	■	■	■
1.80	2.40	3.00	39	3371-1.3-1.80	■	■	■	■
1.90	2.40	3.00	39	3371-1.3-1.90	■	■	■	■
2.00	2.60	3.00	39	3371-1.3-2.00	■	■	■	■
2.05	2.70	3.00	39	3371-1.3-2.05	■	■	■	■
2.20	3.00	3.00	39	3371-1.3-2.20	■	■	■	■
2.50	3.30	3.00	39	3371-1.3-2.50	■	■	■	■
2.80	3.50	3.00	39	3371-1.3-2.80	■	■	■	■
2.90	3.50	3.00	39	3371-1.3-2.90	■	■	■	■

Micro-fraises de précision

Mikropräzisionsfräser

Precision micro end mills

3371-2

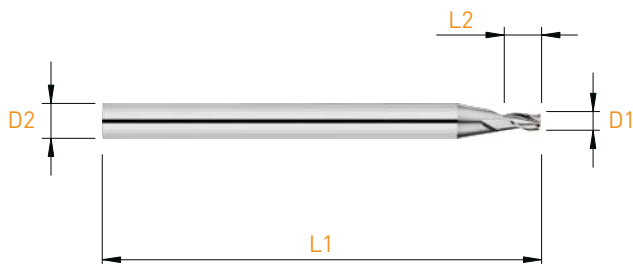

D1 +0.005 / -0.010	L2	D2 h4	L1	Art. N°	Z	TiAlN	TiCN	DLC53
0.30	0.60	3.00	39	3371-2-0.30	■	■	■	■
0.35	0.70	3.00	39	3371-2-0.35	■	■	■	■
0.40	0.80	3.00	39	3371-2-0.40	■	■	■	■
0.45	0.90	3.00	39	3371-2-0.45	■	■	■	■
0.50	1.00	3.00	39	3371-2-0.50	■	■	■	■
0.60	1.20	3.00	39	3371-2-0.60	■	■	■	■
0.70	1.40	3.00	39	3371-2-0.70	■	■	■	■
0.75	1.50	3.00	39	3371-2-0.75	■	■	■	■
0.80	1.60	3.00	39	3371-2-0.80	■	■	■	■
0.90	1.80	3.00	39	3371-2-0.90	■	■	■	■
0.95	1.90	3.00	39	3371-2-0.95	■	■	■	■
1.00	2.00	3.00	39	3371-2-1.00	■	■	■	■
1.10	2.20	3.00	39	3371-2-1.10	■	■	■	■
1.20	2.40	3.00	39	3371-2-1.20	■	■	■	■
1.30	2.60	3.00	39	3371-2-1.30	■	■	■	■
1.40	2.80	3.00	39	3371-2-1.40	■	■	■	■
1.50	3.00	3.00	39	3371-2-1.50	■	■	■	■
1.60	3.20	3.00	39	3371-2-1.60	■	■	■	■
1.70	3.40	3.00	39	3371-2-1.70	■	■	■	■
1.80	3.60	3.00	39	3371-2-1.80	■	■	■	■
1.90	3.80	3.00	39	3371-2-1.90	■	■	■	■
2.00	4.00	3.00	39	3371-2-2.00	■	■	■	■
2.10	4.20	3.00	39	3371-2-2.10	■	■	■	■
2.20	4.40	3.00	39	3371-2-2.20	■	■	■	■
2.30	4.60	3.00	39	3371-2-2.30	■	■	■	■
2.40	4.80	3.00	39	3371-2-2.40	■	■	■	■
2.50	5.00	3.00	39	3371-2-2.50	■	■	■	■
2.60	5.20	3.00	39	3371-2-2.60	■	■	■	■
2.70	5.40	3.00	39	3371-2-2.70	■	■	■	■
2.80	5.60	3.00	39	3371-2-2.80	■	■	■	■
2.90	5.80	3.00	39	3371-2-2.90	■	■	■	■

MICRO-LINE

Micro-fraises de précision

Mikropräzisionsfräser

Precision micro end mills

3371-3

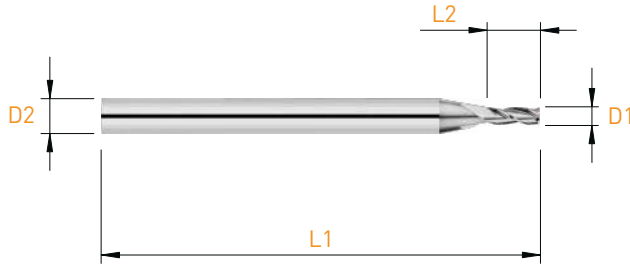

D1 +0.005 / -0.010	L2	D2 h4	L1	Art. N°	N	TiAlN	TiCN	DLC53
0.30	0.90	3.00	39	3371-3-0.30	■	■	■	■
0.40	1.20	3.00	39	3371-3-0.40	■	■	■	■
0.45	1.40	3.00	39	3371-3-0.45	■	■	■	■
0.50	1.50	3.00	39	3371-3-0.50	■	■	■	■
0.55	1.80	3.00	39	3371-3-0.55	■	■	■	■
0.60	2.00	3.00	39	3371-3-0.60	■	■	■	■
0.65	2.00	3.00	39	3371-3-0.65	■	■	■	■
0.70	2.00	3.00	39	3371-3-0.70	■	■	■	■
0.75	2.00	3.00	39	3371-3-0.75	■	■	■	■
0.80	2.50	3.00	39	3371-3-0.80	■	■	■	■
0.85	2.50	3.00	39	3371-3-0.85	■	■	■	■
0.90	2.50	3.00	39	3371-3-0.90	■	■	■	■
0.95	2.90	3.00	39	3371-3-0.95	■	■	■	■
1.00	3.00	3.00	39	3371-3-1.00	■	■	■	■
1.05	3.20	3.00	39	3371-3-1.05	■	■	■	■
1.10	3.30	3.00	39	3371-3-1.10	■	■	■	■
1.15	3.50	3.00	39	3371-3-1.15	■	■	■	■
1.20	4.00	3.00	39	3371-3-1.20	■	■	■	■
1.25	4.00	3.00	39	3371-3-1.25	■	■	■	■
1.30	4.00	3.00	39	3371-3-1.30	■	■	■	■
1.35	4.00	3.00	39	3371-3-1.35	■	■	■	■
1.40	4.00	3.00	39	3371-3-1.40	■	■	■	■
1.45	4.50	3.00	39	3371-3-1.45	■	■	■	■
1.50	4.50	3.00	39	3371-3-1.50	■	■	■	■
1.60	4.50	3.00	39	3371-3-1.60	■	■	■	■
1.65	5.00	3.00	39	3371-3-1.65	■	■	■	■
1.70	5.00	3.00	39	3371-3-1.70	■	■	■	■
1.80	6.00	3.00	39	3371-3-1.80	■	■	■	■
1.85	6.00	3.00	39	3371-3-1.85	■	■	■	■
1.90	6.00	3.00	39	3371-3-1.90	■	■	■	■
1.95	6.00	3.00	39	3371-3-1.95	■	■	■	■

D1 +0.005 / -0.010	L2	D2 h4	L1	Art. N°	N	TiAlN	TiCN	DLC53
2.00	6.00	3.00	39	3371-3-2.00	■	■	■	■
2.10	6.00	3.00	39	3371-3-2.10	■	■	■	■
2.20	6.50	3.00	39	3371-3-2.20	■	■	■	■
2.30	7.00	3.00	39	3371-3-2.30	■	■	■	■
2.40	7.00	3.00	39	3371-3-2.40	■	■	■	■
2.50	7.50	3.00	39	3371-3-2.50	■	■	■	■
2.60	7.50	3.00	39	3371-3-2.60	■	■	■	■
2.70	8.00	3.00	39	3371-3-2.70	■	■	■	■
2.80	8.00	3.00	39	3371-3-2.80	■	■	■	■
2.90	8.50	3.00	39	3371-3-2.90	■	■	■	■

Micro-fraises de précision

Mikropräzisionsfräser

Precision micro end mills

3371-4

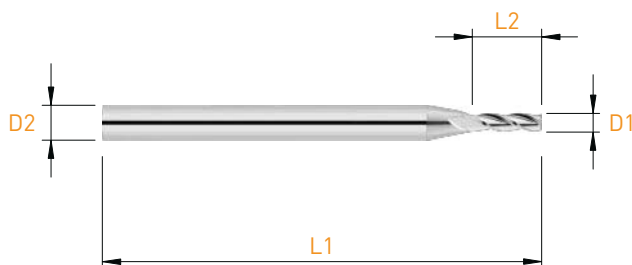

D1 +0.005 / -0.010	L2	D2 h4	L1	Art. N°	Z	TiAlN	TiCN	DLC53
0.30	1.20	3.00	39	3371-4-0.30	■	■	■	■
0.40	1.60	3.00	39	3371-4-0.40	■	■	■	■
0.50	2.00	3.00	39	3371-4-0.50	■	■	■	■
0.60	2.40	3.00	39	3371-4-0.60	■	■	■	■
0.70	2.80	3.00	39	3371-4-0.70	■	■	■	■
0.80	3.20	3.00	39	3371-4-0.80	■	■	■	■
0.90	3.60	3.00	39	3371-4-0.90	■	■	■	■
1.00	4.00	3.00	39	3371-4-1.00	■	■	■	■
1.10	4.40	3.00	39	3371-4-1.10	■	■	■	■
1.20	4.80	3.00	39	3371-4-1.20	■	■	■	■
1.30	5.20	3.00	39	3371-4-1.30	■	■	■	■
1.40	5.60	3.00	39	3371-4-1.40	■	■	■	■
1.50	6.00	3.00	39	3371-4-1.50	■	■	■	■
1.60	6.40	3.00	39	3371-4-1.60	■	■	■	■
1.70	6.80	3.00	39	3371-4-1.70	■	■	■	■
1.80	7.20	3.00	39	3371-4-1.80	■	■	■	■
1.90	7.60	3.00	39	3371-4-1.90	■	■	■	■
2.00	8.00	3.00	39	3371-4-2.00	■	■	■	■
2.10	8.40	3.00	39	3371-4-2.10	■	■	■	■
2.20	8.80	3.00	39	3371-4-2.20	■	■	■	■
2.30	9.20	3.00	39	3371-4-2.30	■	■	■	■
2.40	9.60	3.00	39	3371-4-2.40	■	■	■	■
2.50	10.00	3.00	39	3371-4-2.50	■	■	■	■
2.60	10.40	3.00	39	3371-4-2.60	■	■	■	■
2.70	10.80	3.00	39	3371-4-2.70	■	■	■	■
2.80	11.20	3.00	39	3371-4-2.80	■	■	■	■
2.90	11.60	3.00	39	3371-4-2.90	■	■	■	■

MICRO-LINE

Micro-fraises de précision

Mikropräzisionsfräser

Precision micro end mills

3371-5

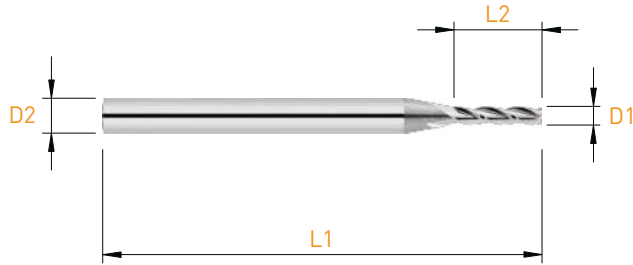

D1 +0.005 / -0.010	L2	D2 h4	L1	Art. N°	Z	TiAlN	TiCN	DLC53
0.50	2.50	3.00	39	3371-5-0.50	■	■	■	■
0.60	3.00	3.00	39	3371-5-0.60	■	■	■	■
0.70	3.50	3.00	39	3371-5-0.70	■	■	■	■
0.80	4.00	3.00	39	3371-5-0.80	■	■	■	■
0.90	4.50	3.00	39	3371-5-0.90	■	■	■	■
1.00	5.00	3.00	39	3371-5-1.00	■	■	■	■
1.10	5.50	3.00	39	3371-5-1.10	■	■	■	■
1.20	6.00	3.00	39	3371-5-1.20	■	■	■	■
1.50	7.50	3.00	39	3371-5-1.50	■	■	■	■
2.00	10.00	3.00	39	3371-5-2.00	■	■	■	■
2.50	12.50	3.00	39	3371-5-2.50	■	■	■	■

Micro-fraises de précision

Mikropräzisionsfräser

Precision micro end mills

3371-8

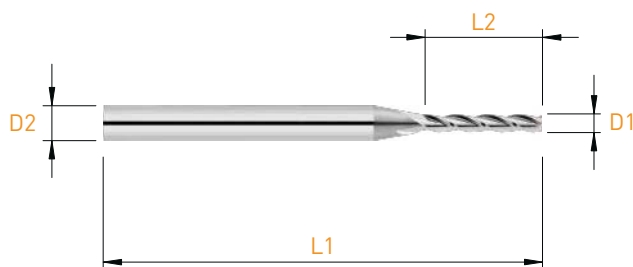

D1 +0.005 / -0.010	L2	D2 h4	L1	Art. N°	Z	TiAlN	TiCN	DLC53
0.50	4.00	3.00	39	3371-8-0.50	■	■	■	■
0.60	5.00	3.00	39	3371-8-0.60	■	■	■	■
0.70	5.60	3.00	39	3371-8-0.70	■	■	■	■
0.80	6.00	3.00	39	3371-8-0.80	■	■	■	■
0.90	7.20	3.00	39	3371-8-0.90	■	■	■	■
1.00	8.00	3.00	39	3371-8-1.00	■	■	■	■
1.20	9.00	3.00	39	3371-8-1.20	■	■	■	■
1.30	11.00	3.00	39	3371-8-1.30	■	■	■	■
1.50	12.00	4.00*	50	3371-8-1.50	■	■	■	■
2.00	16.00	4.00*	50	3371-8-2.00	■	■	■	■
2.50	20.00	4.00*	50	3371-8-2.50	■	■	■	■

* = h6

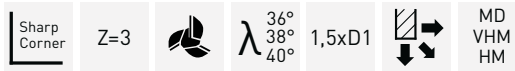
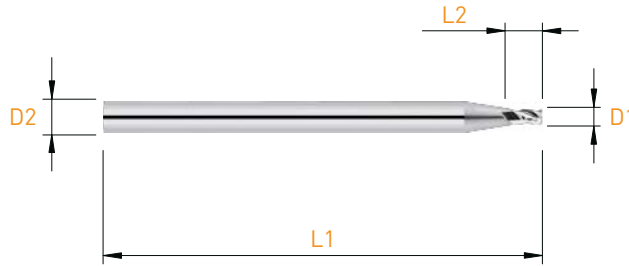

DHD Denture à pas irrégulier, angle d'hélice différent pour chaque dent
 Ungleiche Teilung, unterschiedlicher Drallwinkel
 Uneven tooth pitch, different helix angle per tooth

D1 +0.005 / -0.010	L2	D2 h4	L1	Art. N°	Z	TiAlN	TiCN	DLC53
0.30	0.45	3.00	39	DHD3371-1.5-0.30	■	■	■	■
0.40	0.60	3.00	39	DHD3371-1.5-0.40	■	■	■	■
0.50	0.75	3.00	39	DHD3371-1.5-0.50	■	■	■	■
0.60	0.90	3.00	39	DHD3371-1.5-0.60	■	■	■	■
0.70	1.05	3.00	39	DHD3371-1.5-0.70	■	■	■	■
0.80	1.20	3.00	39	DHD3371-1.5-0.80	■	■	■	■
0.90	1.35	3.00	39	DHD3371-1.5-0.90	■	■	■	■
1.00	1.50	3.00	39	DHD3371-1.5-1.00	■	■	■	■
1.10	1.65	3.00	39	DHD3371-1.5-1.10	■	■	■	■
1.20	1.80	3.00	39	DHD3371-1.5-1.20	■	■	■	■
1.30	1.95	3.00	39	DHD3371-1.5-1.30	■	■	■	■
1.40	2.10	3.00	39	DHD3371-1.5-1.40	■	■	■	■
1.50	2.25	3.00	39	DHD3371-1.5-1.50	■	■	■	■
1.60	2.40	3.00	39	DHD3371-1.5-1.60	■	■	■	■
1.70	2.55	3.00	39	DHD3371-1.5-1.70	■	■	■	■
1.80	2.70	3.00	39	DHD3371-1.5-1.80	■	■	■	■
1.90	2.85	3.00	39	DHD3371-1.5-1.90	■	■	■	■
2.00	3.00	3.00	39	DHD3371-1.5-2.00	■	■	■	■
2.50	3.75	3.00	39	DHD3371-1.5-2.50	■	■	■	■

Micro-fraises de précision

Mikropräzisionsfräser

Precision micro end mills

DHD3371-3

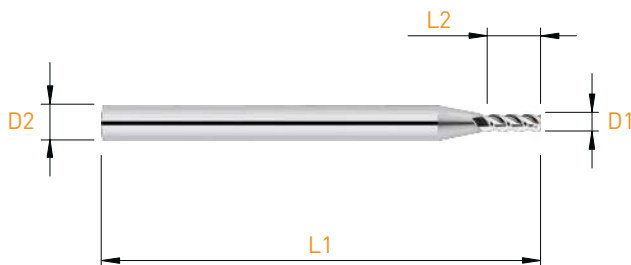

Sharp Corner	Z=3		λ 36° 38° 40°	3xD1		MD VHM HM
--------------	-----	--	-----------------------------	------	--	-----------------

DHD

Denture à pas irrégulier, angle d'hélice différent pour chaque dent
 Ungleiche Teilung, unterschiedlicher Drallwinkel
 Uneven tooth pitch, different helix angle per tooth

D1 +0.005 / -0.010	L2	D2 h4	L1	Art. N°	Z	TiAlN	TiCN	DLC53
0.30	0.90	3.00	39	DHD3371-3-0.30	■	■	■	■
0.40	1.20	3.00	39	DHD3371-3-0.40	■	■	■	■
0.50	1.50	3.00	39	DHD3371-3-0.50	■	■	■	■
0.60	1.80	3.00	39	DHD3371-3-0.60	■	■	■	■
0.70	2.10	3.00	39	DHD3371-3-0.70	■	■	■	■
0.80	2.40	3.00	39	DHD3371-3-0.80	■	■	■	■
0.90	2.70	3.00	39	DHD3371-3-0.90	■	■	■	■
1.00	3.00	3.00	39	DHD3371-3-1.00	■	■	■	■
1.10	3.30	3.00	39	DHD3371-3-1.10	■	■	■	■
1.20	3.60	3.00	39	DHD3371-3-1.20	■	■	■	■
1.30	3.90	3.00	39	DHD3371-3-1.30	■	■	■	■
1.40	4.20	3.00	39	DHD3371-3-1.40	■	■	■	■
1.50	4.50	3.00	39	DHD3371-3-1.50	■	■	■	■
1.60	4.80	3.00	39	DHD3371-3-1.60	■	■	■	■
1.70	5.10	3.00	39	DHD3371-3-1.70	■	■	■	■
1.80	5.40	3.00	39	DHD3371-3-1.80	■	■	■	■
1.90	5.70	3.00	39	DHD3371-3-1.90	■	■	■	■
2.00	6.00	3.00	39	DHD3371-3-2.00	■	■	■	■
2.50	7.50	3.00	39	DHD3371-3-2.50	■	■	■	■

MICRO-LINE

Micro-fraises de précision

Mikropräzisionsfräser

Precision micro end mills

3375-2.5

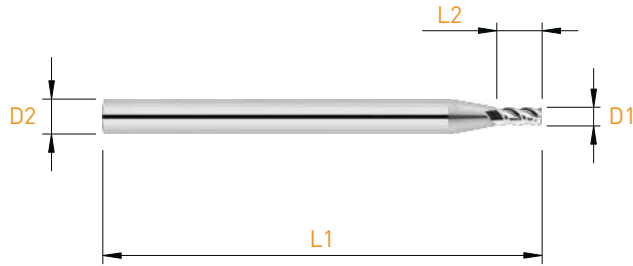

D1 +0.005 / -0.010	L2	D2 h4	L1	Art. N°	Z	TiAlN	TiCN	DLC53
0.30	0.80	3.00	39	3375-2.5-0.30	■	■	■	■
0.40	1.00	3.00	39	3375-2.5-0.40	■	■	■	■
0.50	1.30	3.00	39	3375-2.5-0.50	■	■	■	■
0.60	1.50	3.00	39	3375-2.5-0.60	■	■	■	■
0.70	1.70	3.00	39	3375-2.5-0.70	■	■	■	■
0.80	2.00	3.00	39	3375-2.5-0.80	■	■	■	■
0.90	2.30	3.00	39	3375-2.5-0.90	■	■	■	■
1.00	2.50	3.00	39	3375-2.5-1.00	■	■	■	■
1.10	2.80	3.00	39	3375-2.5-1.10	■	■	■	■
1.20	3.00	3.00	39	3375-2.5-1.20	■	■	■	■
1.30	3.30	3.00	39	3375-2.5-1.30	■	■	■	■
1.40	3.50	3.00	39	3375-2.5-1.40	■	■	■	■
1.50	3.80	3.00	39	3375-2.5-1.50	■	■	■	■
1.60	4.00	3.00	39	3375-2.5-1.60	■	■	■	■
1.70	4.30	3.00	39	3375-2.5-1.70	■	■	■	■
1.80	4.50	3.00	39	3375-2.5-1.80	■	■	■	■
1.90	4.80	3.00	39	3375-2.5-1.90	■	■	■	■
2.00	5.00	3.00	39	3375-2.5-2.00	■	■	■	■
2.10	5.30	3.00	39	3375-2.5-2.10	■	■	■	■
2.20	5.50	3.00	39	3375-2.5-2.20	■	■	■	■
2.30	5.80	3.00	39	3375-2.5-2.30	■	■	■	■
2.40	6.00	3.00	39	3375-2.5-2.40	■	■	■	■
2.50	6.30	3.00	39	3375-2.5-2.50	■	■	■	■
2.60	6.50	3.00	39	3375-2.5-2.60	■	■	■	■
2.70	6.80	3.00	39	3375-2.5-2.70	■	■	■	■
2.80	7.00	3.00	39	3375-2.5-2.80	■	■	■	■
2.90	7.30	3.00	39	3375-2.5-2.90	■	■	■	■

Micro-fraises de précision

Mikropräzisionsfräser

Precision micro end mills

3471-1.5

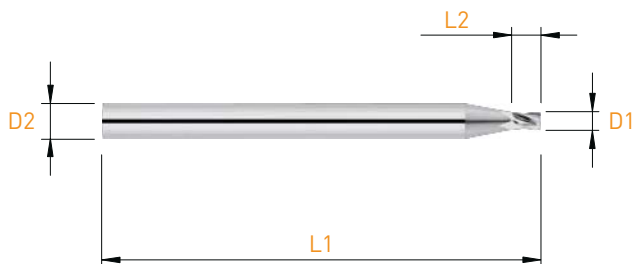

D1 +0.005 / -0.010	L2	D2 h4	L1	Art. N°	Z	TiAlN	TiCN	DLC53
0.30	0.45	3.00	39	3471-1.5-0.30	■	■	■	■
0.40	0.60	3.00	39	3471-1.5-0.40	■	■	■	■
0.50	0.75	3.00	39	3471-1.5-0.50	■	■	■	■
0.60	0.90	3.00	39	3471-1.5-0.60	■	■	■	■
0.70	1.05	3.00	39	3471-1.5-0.70	■	■	■	■
0.80	1.20	3.00	39	3471-1.5-0.80	■	■	■	■
0.90	1.35	3.00	39	3471-1.5-0.90	■	■	■	■
1.00	1.50	3.00	39	3471-1.5-1.00	■	■	■	■
1.10	1.65	3.00	39	3471-1.5-1.10	■	■	■	■
1.20	1.80	3.00	39	3471-1.5-1.20	■	■	■	■
1.30	1.95	3.00	39	3471-1.5-1.30	■	■	■	■
1.40	2.10	3.00	39	3471-1.5-1.40	■	■	■	■
1.50	2.25	3.00	39	3471-1.5-1.50	■	■	■	■
1.60	2.40	3.00	39	3471-1.5-1.60	■	■	■	■
1.70	2.55	3.00	39	3471-1.5-1.70	■	■	■	■
1.80	2.70	3.00	39	3471-1.5-1.80	■	■	■	■
1.90	2.85	3.00	39	3471-1.5-1.90	■	■	■	■
2.00	3.00	3.00	39	3471-1.5-2.00	■	■	■	■
2.10	3.15	3.00	39	3471-1.5-2.10	■	■	■	■
2.20	3.30	3.00	39	3471-1.5-2.20	■	■	■	■
2.30	3.45	3.00	39	3471-1.5-2.30	■	■	■	■
2.40	3.60	3.00	39	3471-1.5-2.40	■	■	■	■
2.50	3.75	3.00	39	3471-1.5-2.50	■	■	■	■
2.60	3.90	3.00	39	3471-1.5-2.60	■	■	■	■
2.70	4.05	3.00	39	3471-1.5-2.70	■	■	■	■
2.80	4.20	3.00	39	3471-1.5-2.80	■	■	■	■
2.90	4.35	3.00	39	3471-1.5-2.90	■	■	■	■

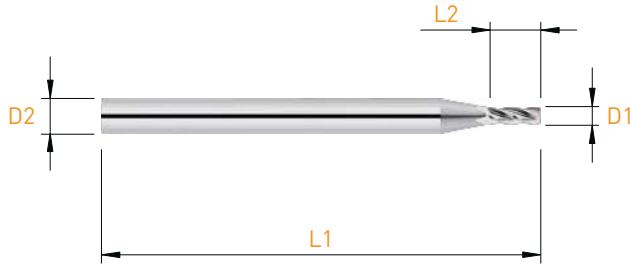

D1 +0.005 / -0.010	L2	D2 h4	L1	Art. N°	Z	TiAlN	TiCN	DLC53
0.30	0.90	3.00	39	3471-3-0.30	■	■	■	■
0.40	1.20	3.00	39	3471-3-0.40	■	■	■	■
0.50	1.50	3.00	39	3471-3-0.50	■	■	■	■
0.55	1.70	3.00	39	3471-3-0.55	■	■	■	■
0.60	1.80	3.00	39	3471-3-0.60	■	■	■	■
0.70	2.10	3.00	39	3471-3-0.70	■	■	■	■
0.75	2.30	3.00	39	3471-3-0.75	■	■	■	■
0.80	2.40	3.00	39	3471-3-0.80	■	■	■	■
0.85	2.60	3.00	39	3471-3-0.85	■	■	■	■
0.90	2.70	3.00	39	3471-3-0.90	■	■	■	■
0.95	2.90	3.00	39	3471-3-0.95	■	■	■	■
1.00	3.00	3.00	39	3471-3-1.00	■	■	■	■
1.10	3.30	3.00	39	3471-3-1.10	■	■	■	■
1.20	3.60	3.00	39	3471-3-1.20	■	■	■	■
1.30	3.90	3.00	39	3471-3-1.30	■	■	■	■
1.40	4.20	3.00	39	3471-3-1.40	■	■	■	■
1.50	4.50	3.00	39	3471-3-1.50	■	■	■	■
1.60	4.80	3.00	39	3471-3-1.60	■	■	■	■
1.70	5.10	3.00	39	3471-3-1.70	■	■	■	■
1.80	5.40	3.00	39	3471-3-1.80	■	■	■	■
1.90	5.70	3.00	39	3471-3-1.90	■	■	■	■
2.00	6.00	3.00	39	3471-3-2.00	■	■	■	■
2.10	6.30	3.00	39	3471-3-2.10	■	■	■	■
2.20	6.60	3.00	39	3471-3-2.20	■	■	■	■
2.30	6.90	3.00	39	3471-3-2.30	■	■	■	■
2.40	7.20	3.00	39	3471-3-2.40	■	■	■	■
2.50	7.50	3.00	39	3471-3-2.50	■	■	■	■
2.60	7.80	3.00	39	3471-3-2.60	■	■	■	■
2.70	8.10	3.00	39	3471-3-2.70	■	■	■	■
2.80	8.40	3.00	39	3471-3-2.80	■	■	■	■
2.90	8.70	3.00	39	3471-3-2.90	■	■	■	■

Micro-fraises de précision

Mikropräzisionsfräser

Precision micro end mills

DHP3471-3

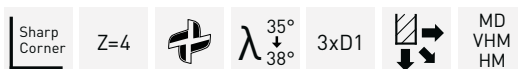
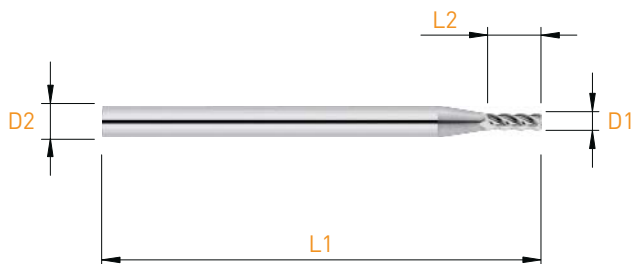

DHP Denture à pas irrégulier, angle d'hélice progressive
 Ungleiche Teilung, progressive Drallwinkel
 Uneven tooth pitch, progressive helix angle

D1 +0.005 / -0.010	L2	D2 h4	L1	Art. N°	Z	TiAlN	TiCN	DLC53
0.50	1.50	3.00	39	DHP3471-3-0.50	■	■	■	■
0.60	1.80	3.00	39	DHP3471-3-0.60	■	■	■	■
0.70	2.10	3.00	39	DHP3471-3-0.70	■	■	■	■
0.80	2.40	3.00	39	DHP3471-3-0.80	■	■	■	■
0.90	2.70	3.00	39	DHP3471-3-0.90	■	■	■	■
1.00	3.00	3.00	39	DHP3471-3-1.00	■	■	■	■
1.10	3.30	3.00	39	DHP3471-3-1.10	■	■	■	■
1.20	3.60	3.00	39	DHP3471-3-1.20	■	■	■	■
1.30	3.90	3.00	39	DHP3471-3-1.30	■	■	■	■
1.40	4.20	3.00	39	DHP3471-3-1.40	■	■	■	■
1.50	4.50	3.00	39	DHP3471-3-1.50	■	■	■	■
1.60	4.80	3.00	39	DHP3471-3-1.60	■	■	■	■
1.70	5.10	3.00	39	DHP3471-3-1.70	■	■	■	■
1.80	5.40	3.00	39	DHP3471-3-1.80	■	■	■	■
1.90	5.70	3.00	39	DHP3471-3-1.90	■	■	■	■
2.00	6.00	3.00	39	DHP3471-3-2.00	■	■	■	■
2.50	7.50	3.00	39	DHP3471-3-2.50	■	■	■	■

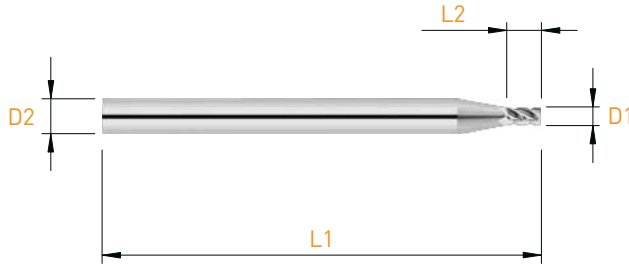

D1 +0.005 / -0.010	L2	D2 h4	L1	Art. N°	Z	TiAlN	TiCN	DLC53
0.30	0.60	3.00	39	3472-2-0.30	■	■	■	■
0.40	0.80	3.00	39	3472-2-0.40	■	■	■	■
0.50	1.00	3.00	39	3472-2-0.50	■	■	■	■
0.60	1.20	3.00	39	3472-2-0.60	■	■	■	■
0.70	1.40	3.00	39	3472-2-0.70	■	■	■	■
0.80	1.60	3.00	39	3472-2-0.80	■	■	■	■
0.90	1.80	3.00	39	3472-2-0.90	■	■	■	■
1.00	2.00	3.00	39	3472-2-1.00	■	■	■	■
1.10	2.20	3.00	39	3472-2-1.10	■	■	■	■
1.20	2.40	3.00	39	3472-2-1.20	■	■	■	■
1.30	2.60	3.00	39	3472-2-1.30	■	■	■	■
1.40	2.80	3.00	39	3472-2-1.40	■	■	■	■
1.50	3.00	3.00	39	3472-2-1.50	■	■	■	■
1.60	3.20	3.00	39	3472-2-1.60	■	■	■	■
1.70	3.40	3.00	39	3472-2-1.70	■	■	■	■
1.80	3.60	3.00	39	3472-2-1.80	■	■	■	■
1.90	3.80	3.00	39	3472-2-1.90	■	■	■	■
2.00	4.00	3.00	39	3472-2-2.00	■	■	■	■
2.10	4.20	3.00	39	3472-2-2.10	■	■	■	■
2.20	4.40	3.00	39	3472-2-2.20	■	■	■	■
2.30	4.60	3.00	39	3472-2-2.30	■	■	■	■
2.40	4.80	3.00	39	3472-2-2.40	■	■	■	■
2.50	5.00	3.00	39	3472-2-2.50	■	■	■	■
2.60	5.20	3.00	39	3472-2-2.60	■	■	■	■
2.70	5.40	3.00	39	3472-2-2.70	■	■	■	■
2.80	5.60	3.00	39	3472-2-2.80	■	■	■	■
2.90	5.80	3.00	39	3472-2-2.90	■	■	■	■

Micro-fraises de précision

Mikropräzisionsfräser

Precision micro end mills

3472-4

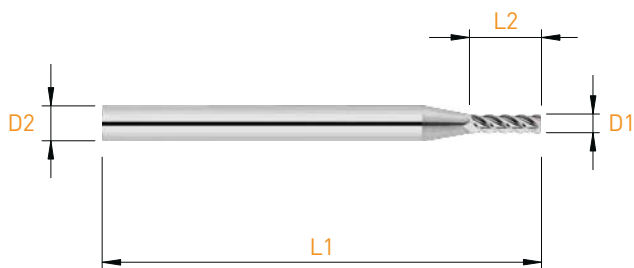

D1 +0.005 / -0.010	L2	D2 h4	L1	Art. N°	Z	TiAIN	TiCN	DLC53
0.40	1.60	3.00	39	3472-4-0.40	■	■	■	■
0.50	2.00	3.00	39	3472-4-0.50	■	■	■	■
0.60	2.40	3.00	39	3472-4-0.60	■	■	■	■
0.70	2.80	3.00	39	3472-4-0.70	■	■	■	■
0.80	3.20	3.00	39	3472-4-0.80	■	■	■	■
0.90	3.60	3.00	39	3472-4-0.90	■	■	■	■
1.00	4.00	3.00	39	3472-4-1.00	■	■	■	■
1.10	4.40	3.00	39	3472-4-1.10	■	■	■	■
1.20	4.80	3.00	39	3472-4-1.20	■	■	■	■
1.30	5.20	3.00	39	3472-4-1.30	■	■	■	■
1.40	5.60	3.00	39	3472-4-1.40	■	■	■	■
1.50	6.00	3.00	39	3472-4-1.50	■	■	■	■
1.60	6.40	3.00	39	3472-4-1.60	■	■	■	■
1.70	6.80	3.00	39	3472-4-1.70	■	■	■	■
1.80	7.20	3.00	39	3472-4-1.80	■	■	■	■
1.90	7.60	3.00	39	3472-4-1.90	■	■	■	■
2.00	8.00	3.00	39	3472-4-2.00	■	■	■	■
2.10	8.40	3.00	39	3472-4-2.10	■	■	■	■
2.20	8.80	3.00	39	3472-4-2.20	■	■	■	■
2.30	9.20	3.00	39	3472-4-2.30	■	■	■	■
2.40	9.60	3.00	39	3472-4-2.40	■	■	■	■
2.50	10.00	3.00	39	3472-4-2.50	■	■	■	■
2.60	10.40	3.00	39	3472-4-2.60	■	■	■	■
2.70	10.80	3.00	39	3472-4-2.70	■	■	■	■
2.80	11.20	3.00	39	3472-4-2.80	■	■	■	■
2.90	11.60	3.00	39	3472-4-2.90	■	■	■	■

MICRO-LINE

Micro-fraises de précision

Mikropräzisionsfräser

Precision micro end mills

3278-0.75

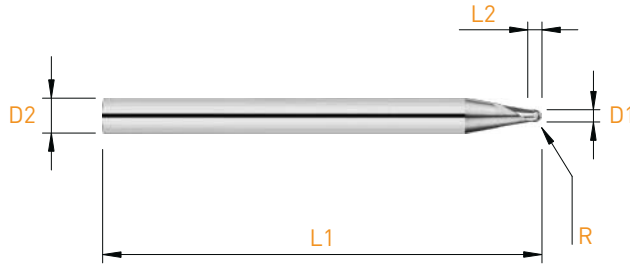

Z=2



λ^{30°

0.75xD1



MD
VHM
HM

D1 +0.005 / -0.010	R	L2	D2 h4	L1	Art. N°	Z	TiAIN	TiCN	DLC53
0.20	0.10	0.15	3.00	39	3278-0.75-0.20	■			
0.30	0.15	0.20	3.00	39	3278-0.75-0.30	■	■	■	■
0.40	0.20	0.30	3.00	39	3278-0.75-0.40	■	■	■	■
0.50	0.25	0.35	3.00	39	3278-0.75-0.50	■	■	■	■
0.60	0.30	0.45	3.00	39	3278-0.75-0.60	■	■	■	■
0.70	0.35	0.55	3.00	39	3278-0.75-0.70	■	■	■	■
0.80	0.40	0.60	3.00	39	3278-0.75-0.80	■	■	■	■
0.90	0.45	0.70	3.00	39	3278-0.75-0.90	■	■	■	■
1.00	0.50	0.75	3.00	39	3278-0.75-1.00	■	■	■	■
1.50	0.75	1.15	3.00	39	3278-0.75-1.50	■	■	■	■
2.00	1.00	1.50	3.00	39	3278-0.75-2.00	■	■	■	■
2.50	1.25	1.90	3.00	39	3278-0.75-2.50	■	■	■	■

Micro-fraises de précision

Mikropräzisionsfräser

Precision micro end mills

3278-1

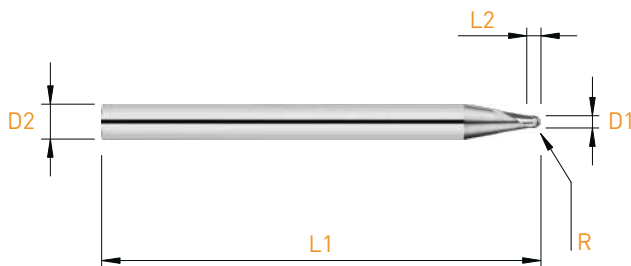

D1 +0.005 / -0.010	L2	D2 h4	L1	Art. N°	Z	TiAIN	TiCN	DLC53
0.20	0.20	3.00	39	3278-1-0.20	■			
0.30	0.30	3.00	39	3278-1-0.30	■	■	■	■
0.40	0.40	3.00	39	3278-1-0.40	■	■	■	■
0.50	0.50	3.00	39	3278-1-0.50	■	■	■	■
0.60	0.60	3.00	39	3278-1-0.60	■	■	■	■
0.70	0.70	3.00	39	3278-1-0.70	■	■	■	■
0.80	0.80	3.00	39	3278-1-0.80	■	■	■	■
0.90	0.90	3.00	39	3278-1-0.90	■	■	■	■
1.00	1.00	3.00	39	3278-1-1.00	■	■	■	■
1.10	1.10	3.00	39	3278-1-1.10	■	■	■	■
1.20	1.20	3.00	39	3278-1-1.20	■	■	■	■
1.30	1.30	3.00	39	3278-1-1.30	■	■	■	■
1.40	1.40	3.00	39	3278-1-1.40	■	■	■	■
1.50	1.50	3.00	39	3278-1-1.50	■	■	■	■
1.60	1.60	3.00	39	3278-1-1.60	■	■	■	■
1.70	1.70	3.00	39	3278-1-1.70	■	■	■	■
1.80	1.80	3.00	39	3278-1-1.80	■	■	■	■
1.90	1.90	3.00	39	3278-1-1.90	■	■	■	■
2.00	2.00	3.00	39	3278-1-2.00	■	■	■	■
2.10	2.10	3.00	39	3278-1-2.10	■	■	■	■
2.20	2.20	3.00	39	3278-1-2.20	■	■	■	■
2.30	2.30	3.00	39	3278-1-2.30	■	■	■	■
2.40	2.40	3.00	39	3278-1-2.40	■	■	■	■
2.50	2.50	3.00	39	3278-1-2.50	■	■	■	■
2.60	2.60	3.00	39	3278-1-2.60	■	■	■	■
2.70	2.70	3.00	39	3278-1-2.70	■	■	■	■
2.80	2.80	3.00	39	3278-1-2.80	■	■	■	■
2.90	2.90	3.00	39	3278-1-2.90	■	■	■	■

MICRO-LINE

Micro-fraises de précision

Mikropräzisionsfräser

Precision micro end mills

3278-1.5

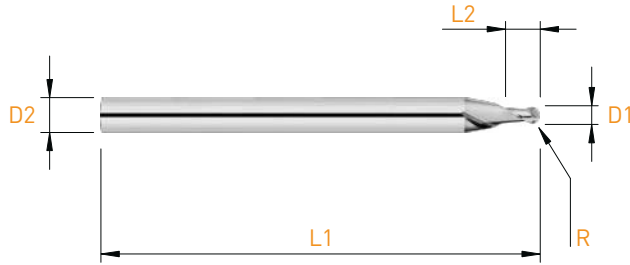

D1 +0.005 / -0.010	R	L2	D2 h4	L1	Art. N°	Z	TiAlN	TiCN	DLC53
0.20	0.10	0.30	3.00	39	3278-1.5-0.20	■			
0.25	0.125	0.35	3.00	39	3278-1.5-0.25	■			
0.30	0.15	0.45	3.00	39	3278-1.5-0.30	■	■	■	■
0.40	0.20	0.60	3.00	39	3278-1.5-0.40	■	■	■	■
0.50	0.25	0.75	3.00	39	3278-1.5-0.50	■	■	■	■
0.60	0.30	0.90	3.00	39	3278-1.5-0.60	■	■	■	■
0.70	0.35	1.05	3.00	39	3278-1.5-0.70	■	■	■	■
0.80	0.40	1.20	3.00	39	3278-1.5-0.80	■	■	■	■
0.85	0.40	1.30	3.00	39	3278-1.5-0.85	■	■	■	■
0.90	0.45	1.35	3.00	39	3278-1.5-0.90	■	■	■	■
1.00	0.50	1.50	3.00	39	3278-1.5-1.00	■	■	■	■
1.10	0.55	1.65	3.00	39	3278-1.5-1.10	■	■	■	■
1.15	0.55	1.75	3.00	39	3278-1.5-1.15	■	■	■	■
1.20	0.60	1.80	3.00	39	3278-1.5-1.20	■	■	■	■
1.30	0.65	1.95	3.00	39	3278-1.5-1.30	■	■	■	■
1.40	0.70	2.10	3.00	39	3278-1.5-1.40	■	■	■	■
1.50	0.75	2.25	3.00	39	3278-1.5-1.50	■	■	■	■
1.60	0.80	2.40	3.00	39	3278-1.5-1.60	■	■	■	■
1.70	0.85	2.60	3.00	39	3278-1.5-1.70	■	■	■	■
1.80	0.90	2.70	3.00	39	3278-1.5-1.80	■	■	■	■
1.90	0.95	2.90	3.00	39	3278-1.5-1.90	■	■	■	■
2.00	1.00	3.00	3.00	39	3278-1.5-2.00	■	■	■	■
2.10	1.05	3.20	3.00	39	3278-1.5-2.10	■	■	■	■
2.20	1.10	3.30	3.00	39	3278-1.5-2.20	■	■	■	■
2.30	1.15	3.50	3.00	39	3278-1.5-2.30	■	■	■	■
2.40	1.20	3.60	3.00	39	3278-1.5-2.40	■	■	■	■
2.50	1.25	3.75	3.00	39	3278-1.5-2.50	■	■	■	■
2.60	1.30	3.90	3.00	39	3278-1.5-2.60	■	■	■	■
2.70	1.35	4.00	3.00	39	3278-1.5-2.70	■	■	■	■
2.80	1.40	4.20	3.00	39	3278-1.5-2.80	■	■	■	■
2.90	1.45	4.40	3.00	39	3278-1.5-2.90	■	■	■	■

Micro-fraises de précision

Mikropräzisionsfräser

Precision micro end mills

3278-3

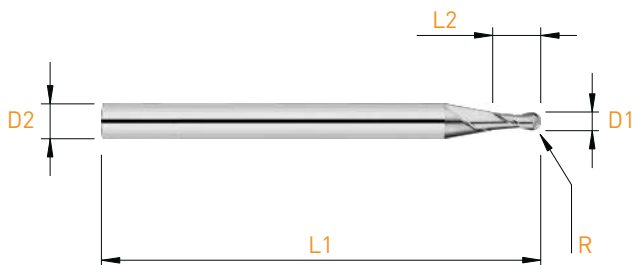

D1 +0.005 / -0.010	R	L2	D2 h4	L1	Art. N°	Z	TiAlN	TiCN	DLC53
0.20	0.10	0.60	3.00	39	3278-3-0.20	■			
0.30	0.15	1.00	3.00	39	3278-3-0.30	■	■	■	■
0.40	0.20	1.00	3.00	39	3278-3-0.40	■	■	■	■
0.50	0.25	1.50	3.00	39	3278-3-0.50	■	■	■	■
0.60	0.30	1.50	3.00	39	3278-3-0.60	■	■	■	■
0.70	0.35	2.00	3.00	39	3278-3-0.70	■	■	■	■
0.80	0.40	2.00	3.00	39	3278-3-0.80	■	■	■	■
0.90	0.45	2.50	3.00	39	3278-3-0.90	■	■	■	■
1.00	0.50	3.00	3.00	39	3278-3-1.00	■	■	■	■
1.20	0.60	4.00	3.00	39	3278-3-1.20	■	■	■	■
1.30	0.65	4.00	3.00	39	3278-3-1.30	■	■	■	■
1.40	0.70	4.00	3.00	39	3278-3-1.40	■	■	■	■
1.50	0.75	4.50	3.00	39	3278-3-1.50	■	■	■	■
1.55	0.775	5.00	3.00	39	3278-3-1.55	■	■	■	■
1.60	0.80	5.00	3.00	39	3278-3-1.60	■	■	■	■
1.80	0.90	5.50	3.00	39	3278-3-1.80	■	■	■	■
2.00	1.00	6.00	3.00	39	3278-3-2.00	■	■	■	■
2.10	1.05	6.50	3.00	39	3278-3-2.10	■	■	■	■
2.20	1.10	7.00	3.00	39	3278-3-2.20	■	■	■	■
2.50	1.25	7.50	3.00	39	3278-3-2.50	■	■	■	■
2.60	1.30	7.80	3.00	39	3278-3-2.60	■	■	■	■
2.70	1.35	8.10	3.00	39	3278-3-2.70	■	■	■	■
2.80	1.40	8.40	3.00	39	3278-3-2.80	■	■	■	■
2.90	1.45	8.70	3.00	39	3278-3-2.90	■	■	■	■

Matière Werkstoff Material	Lubrifiant Kühlung Coolant	VC (m/min)	fz Ø									Non revêtu Unbeschichtet Uncoated	Revêtu Beschichtet Coated
			1.0	2.0	3.0	4.0	5.0	6.0	8.0	10.0			
Acier Stahl Steel < 700 N/mm ² P	O/E	120	0.015	0.02	0.02	0.03	0.03	0.04	0.04	0.045	-	++	
Acier Stahl Steel > 700 N/mm ² P	O/E	100	0.01	0.015	0.015	0.02	0.025	0.03	0.035	0.04	-	++	
Fonte Gusseisen Cast iron K	O/E	130	0.015	0.02	0.025	0.035	0.035	0.045	0.05	0.06	-	++	
Acier inoxydable Rostfreistahl Stainless steel M	O/E	100	0.004	0.008	0.01	0.015	0.02	0.025	0.03	0.04	-	++	
Aluminium N	O/E	300	0.02	0.03	0.03	0.045	0.05	0.06	0.075	0.09	+	++	
Cuivre, laiton, bronze Kupfer, Messing, Bronze Copper, brass, bronze N	O/E	160	0.008	0.015	0.025	0.03	0.03	0.04	0.06	0.07	+	++	
Métaux précieux Edelmetalle Precious metals N	O/E	180	0.008	0.015	0.025	0.03	0.03	0.04	0.06	0.07	+	++	
Titane Titan Titanium S	O/E	60	0.007	0.01	0.015	0.015	0.02	0.025	0.03	0.04	-	++	

Fraises ébauches

Schrupfräser

Roughing mills

E-DHP3300 / 3400

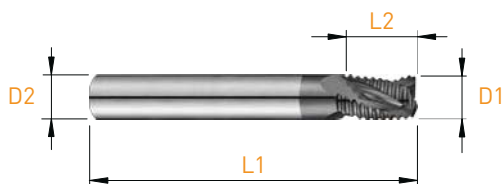

	Z	E	λ	D1	L2	D2 h ₆	L1	Art. N°	Z	TiAlN
	3	0.05	26°/30°	1.00	1.50	3.00	39	E-DHP3300-1.5-1.00	<input type="checkbox"/>	<input checked="" type="checkbox"/>
	3	0.10	26°/30°	1.50	2.25	3.00	39	E-DHP3300-1.5-1.50	<input type="checkbox"/>	<input checked="" type="checkbox"/>
	3	0.20	26°/30°	2.00	3.00	3.00	39	E-DHP3300-1.5-2.00	<input type="checkbox"/>	<input checked="" type="checkbox"/>
	3	0.20	26°/33°	2.50	3.75	6.00	51	E-DHP3300-1.5-2.50	<input type="checkbox"/>	<input checked="" type="checkbox"/>
	3	0.20	26°/33°	3.00	4.25	6.00	51	E-DHP3300-1.5-3.00	<input type="checkbox"/>	<input checked="" type="checkbox"/>
	3	0.30	26°/33°	4.00	6.00	6.00	51	E-DHP3300-1.5-4.00	<input type="checkbox"/>	<input checked="" type="checkbox"/>
	3	0.30	26°/33°	5.00	7.50	6.00	51	E-DHP3300-1.5-5.00	<input type="checkbox"/>	<input checked="" type="checkbox"/>
	3	0.40	26°/33°	6.00	9.00	6.00	51	E-DHP3300-1.5-6.00	<input type="checkbox"/>	<input checked="" type="checkbox"/>
	3	0.50	26°/33°	8.00	12.00	8.00	64	E-DHP3300-1.5-8.00	<input type="checkbox"/>	<input checked="" type="checkbox"/>
	4	0.50	26°/33°	10.00	15.00	10.00	73	E-DHP3400-1.5-10.00	<input type="checkbox"/>	<input checked="" type="checkbox"/>

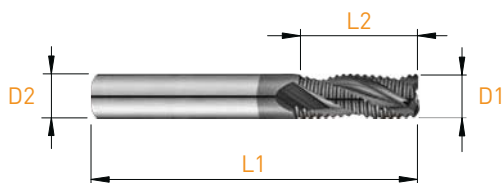

	Z	E	λ	D1	L2	D2 h ₆	L1	Art. N°	Z	TiAlN
	3	0.05	26°/30°	1.00	2.50	3.00	39	E-DHP3300-2.5-1.00	<input type="checkbox"/>	<input checked="" type="checkbox"/>
	3	0.10	26°/30°	1.50	3.75	3.00	39	E-DHP3300-2.5-1.50	<input type="checkbox"/>	<input checked="" type="checkbox"/>
	3	0.20	26°/30°	2.00	5.00	3.00	39	E-DHP3300-2.5-2.00	<input type="checkbox"/>	<input checked="" type="checkbox"/>
	3	0.20	26°/33°	2.50	6.25	6.00	58	E-DHP3300-2.5-2.50	<input type="checkbox"/>	<input checked="" type="checkbox"/>
	3	0.20	26°/33°	3.00	7.50	6.00	58	E-DHP3300-2.5-3.00	<input type="checkbox"/>	<input checked="" type="checkbox"/>
	3	0.30	26°/33°	4.00	10.00	6.00	58	E-DHP3300-2.5-4.00	<input type="checkbox"/>	<input checked="" type="checkbox"/>
	3	0.30	26°/33°	5.00	12.50	6.00	58	E-DHP3300-2.5-5.00	<input type="checkbox"/>	<input checked="" type="checkbox"/>
	3	0.40	26°/33°	6.00	15.00	6.00	58	E-DHP3300-2.5-6.00	<input type="checkbox"/>	<input checked="" type="checkbox"/>
	3	0.50	26°/33°	8.00	20.00	8.00	64	E-DHP3300-2.5-8.00	<input type="checkbox"/>	<input checked="" type="checkbox"/>
	4	0.50	26°/33°	10.00	25.00	10.00	73	E-DHP3400-2.5-10.00	<input type="checkbox"/>	<input checked="" type="checkbox"/>

MICRO-LINE

Fraises en bout de finition

Schlicht Schaftfräser

Finishing end mills

Dimensions disponibles

Verfügbare Abmessungen

Available dimensions

Ø D1	Z = 2		Z = 3						Z = 4						
	3230	3231	30°			3330	3331	DHP3336	3341	3361	3430	3431	DHP3436	3440-S	3441
			3330-S	3336-HA	3337-HA										
1.00	■		■				■					■	■		
1.50	■		■	■	■		■					■	■		
1.80				■	■										
2.00	■	■	■	■	■		■	■	■		■	■	■	■	
2.50	■	■	■	■	■		■	■	■		■	■	■	■	
2.80				■	■										
3.00	■	■	■	■	■	■	■	■	■	■	■	■	■	■	
3.50		■	■	■	■		■	■	■		■	■	■	■	
3.80				■	■										
4.00	■	■	■	■	■	■	■	■	■	■	■	■	■	■	
4.50		■	■	■	■		■	■	■		■	■	■	■	
4.80				■	■										
5.00	■	■	■	■	■	■	■	■	■	■	■	■	■	■	
5.50				■	■								■	■	
5.80				■	■										
6.00	■	■	■	■	■	■	■	■	■	■	■	■	■	■	
8.00					■										
10.00					■										
12.00					■										

Paramètres de coupe indicatifs

Empfohlene Schnittwerte





Standard machining data



Matière Werkstoff Material	VC (m/min)	fz [mm/z]	
		Ø 2 - 4	Ø 4 - 6
Acier Stahl < 700 N/mm ² Steel	P 60 - 100	0.010 - 0.030	0.015 - 0.040
Acier Stahl > 700 N/mm ² Steel	P 40 - 70	0.008 - 0.020	0.010 - 0.030
Acier inoxydable Rostfreistahl Stainless steel	M 40 - 80	0.010 - 0.030	0.015 - 0.040
Aluminium	N 100 - 250	0.015 - 0.050	0.020 - 0.060
Cuivre Kupfer Copper	N 80 - 160	0.010 - 0.040	0.020 - 0.060
Laiton Messing Brass	N 100 - 200	0.015 - 0.040	0.030 - 0.070
Titane Titan Titanium	S 25 - 50	0.010 - 0.030	0.015 - 0.040



Fraises en bout de finition



Schlicht Schafffräser

Finishing end mills

	Fraises en bout avec angles vifs Schafffräser mit scharfkantiger Ecken End mills with sharp corners							
	Z	Helix	L2	Range	Shank	Type	page	
	Z = 2	30°	1 x D1	Ø 1.00 - 6.00	Ø 6.0	3230	13.38	
			~ 3-4 x D1	Ø 2.00 - 6.00	D1 = D2	3231	13.39	
	Z = 3	30°	1 x D1	Ø 3.00 - 12.00	D1 = D2	3330	13.40	
			~ 1.2-2 x D1	Ø 1.00 - 6.00	Ø 6.0	3330-S	13.41	
			~ 1.2-2 x D1	Ø 1.50 - 6.00	Ø 6.0	3336-HA	13.42	
			~ 2-4 x D1	Ø 1.50 - 6.00	Ø 6.0	3337-HA	13.42	
			~ 3-4 x D1	Ø 2.00 - 6.00	D1 = D2	3331	13.43	
			35° - 38°	4.0 - 8.0	Ø 1.00 - 6.00	Ø 6.0	DHP3336	13.44
	Z = 3	30°	~ 3-4 x D1	Ø 2.00 - 6.00	D1 = D2	3341	13.45	
			~ 3-4 x D1	Ø 2.00 - 6.00	D1 = D2	3361	13.46	
			35° - 38°	1 x D1	Ø 3.00 - 6.00	D1 = D2	3430	13.47
				~ 3-4 x D1	Ø 2.00 - 6.00	D1 = D2	3431	13.48
	Z = 4	35° - 38°	4.0 - 8.0	Ø 1.00 - 6.00	Ø 6.0	DHP3436	13.49	
			45°	2 x D1	Ø 1.00 - 6.00	Ø 6.0	3440-S	13.50
				~ 3-4 x D1	Ø 2.00 - 6.00	D1 = D2	3441	13.51

	Fraises en bout hémisphériques Vollradius Schafffräser Ball nose end mills						
	Z	Helix	L2	Range	Shank	Type	page
	Z = 2	30°	~ 3-4 x D1	Ø 2.00 - 6.00	D1 = D2	3238	13.52
	Z = 3		~ 3-4 x D1	Ø 2.00 - 6.00	D1 = D2	3338	13.53

	Fraises en bout avec queue réduite Schafffräser mit reduziertem Schaft End mills with reduced shank						
	Z	Helix	L2	Range	Shank	Type	page
	Z = 3	30°	1 x D1	Ø 8.00 - 12.00	Ø 6.0	3383	13.54
	Z = 10		15.0	Ø 16.3 / 20.3	Ø 10.0	3831 / 3833	13.55

	Fraises en bout de finition pour machine WM 701S Schafffräser für Machine WM 701S End mills for machine WM 701S						
	Z	Helix	L2	Range	Shank	Type	page
	Z = 3	30°	0.30-10.50	Ø 0.30 - 3.50	Ø 6.0	701S3371	13.56

	Fraises à angler Kegelsenker Chamfering tools						
	Z	Helix	L2	Range	Shank	Type	page
	Z = 3	0°	-	Ø 0.50 - 3.00	Ø 3.0 h4	3911	13.58
	Z = 4		-	Ø 3.00 - 8.00	D1 = D2	1901 / 3901	13.59



Z=2



λ 30°



MD
VHM
HM

D1 h10	L2	D2 h6	L1	Art. N°	Z	TiAIN
1.00	1.00	6.00	51	3230-1.0	■	■
1.50	1.50	6.00	51	3230-1.5	■	■
2.00	2.00	6.00	51	3230-2.0	■	■
2.50	2.50	6.00	51	3230-2.5	■	■
3.00	3.00	6.00	51	3230-3.0	■	■
4.00	4.00	6.00	51	3230-4.0	■	■
5.00	5.00	6.00	51	3230-5.0	■	■
6.00	6.00	6.00	51	3230-6.0	■	■

Fraises en bout de finition

Schlicht Schafffräser

Finishing end mills

3231

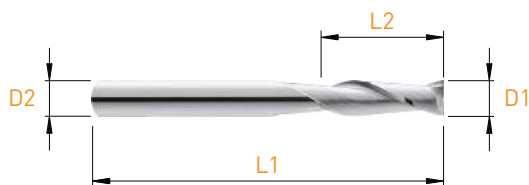

D1 e9	L2	D2 h6	L1	Art. N°	Z	TiAIN
2.00	8.00	2.00	32	3231-2.0	■	■
2.50	8.00	2.50	32	3231-2.5	■	■
3.00	12.00	3.00	32	3231-3.0	■	■
3.50	12.00	3.50	32	3231-3.5	■	■
4.00	12.00	4.00	40	3231-4.0	■	■
4.50	14.00	4.50	50	3231-4.5	■	■
5.00	14.00	5.00	50	3231-5.0	■	■
6.00	16.00	6.00	51	3231-6.0	■	■



D1 e9	L2	D2 h6	L1	Art. N°	Z	TiAIN
3.00	3.00	3.00	39	3330-3.0	■	■
4.00	4.00	4.00	50	3330-4.0	■	■
5.00	5.00	5.00	50	3330-5.0	■	■
6.00	6.00	6.00	51	3330-6.0	■	■
8.00	8.00	8.00	58	3330-8.0	■	
10.00	10.00	10.00	66	3330-10.0	■	
12.00	12.00	12.00	73	3330-12.0	■	

Fraises en bout de finition

Schlicht Schafffräser

Finishing end mills

3330-S



D1 h10	L2	D2 h6	L1	Art. N°	Z	TiAIN
1.00	3.00	6.00	40	3330-S-1.0	■	■
1.50	3.00	6.00	40	3330-S-1.5	■	■
2.00	3.00	6.00	40	3330-S-2.0	■	■
2.50	3.00	6.00	40	3330-S-2.5	■	■
3.00	4.00	6.00	40	3330-S-3.0	■	■
3.50	4.00	6.00	40	3330-S-3.5	■	■
4.00	5.00	6.00	40	3330-S-4.0	■	■
4.50	5.00	6.00	40	3330-S-4.5	■	■
5.00	6.00	6.00	40	3330-S-5.0	■	■
6.00	7.00	6.00	40	3330-S-6.0	■	■

MICRO-LINE

Fraises en bout de finition

Schlicht Schaftfräser

Finishing end mills

3336-HA / 3337-HA

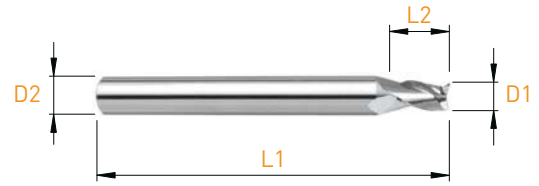
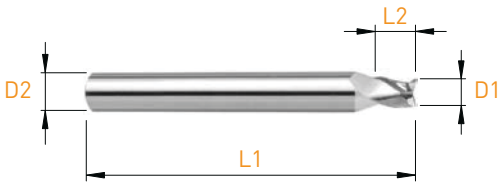

D1 h10	L2	D2 h6	L1	Art. N°	Z	TiAlN
1.50	3.00	6.00	51	3336-HA-1.5	■	■
1.80	3.00	6.00	51	3336-HA-1.8	■	■
2.00	3.00	6.00	51	3336-HA-2.0	■	■
2.50	3.00	6.00	51	3336-HA-2.5	■	■
2.80	4.00	6.00	51	3336-HA-2.8	■	■
3.00	4.00	6.00	51	3336-HA-3.0	■	■
3.50	4.00	6.00	51	3336-HA-3.5	■	■
3.80	5.00	6.00	54	3336-HA-3.8	■	■
4.00	5.00	6.00	54	3336-HA-4.0	■	■
4.50	5.00	6.00	54	3336-HA-4.5	■	■
4.80	6.00	6.00	54	3336-HA-4.8	■	■
5.00	6.00	6.00	54	3336-HA-5.0	■	■
5.50	7.00	6.00	54	3336-HA-5.5	■	■
5.80	7.00	6.00	54	3336-HA-5.8	■	■
6.00	7.00	6.00	54	3336-HA-6.0	■	■

D1 h10	L2	D2 h6	L1	Art. N°	Z	TiAlN
1.50	6.00	6.00	57	3337-HA-1.5	■	■
1.80	6.00	6.00	57	3337-HA-1.8	■	■
2.00	6.00	6.00	57	3337-HA-2.0	■	■
2.50	6.00	6.00	57	3337-HA-2.5	■	■
2.80	7.00	6.00	57	3337-HA-2.8	■	■
3.00	7.00	6.00	57	3337-HA-3.0	■	■
3.50	7.00	6.00	57	3337-HA-3.5	■	■
3.80	8.00	6.00	57	3337-HA-3.8	■	■
4.00	8.00	6.00	57	3337-HA-4.0	■	■
4.50	8.00	6.00	57	3337-HA-4.5	■	■
4.80	10.00	6.00	57	3337-HA-4.8	■	■
5.00	10.00	6.00	57	3337-HA-5.0	■	■
5.50	10.00	6.00	57	3337-HA-5.5	■	■
5.80	10.00	6.00	57	3337-HA-5.8	■	■
6.00	10.00	6.00	57	3337-HA-6.0	■	■

Fraises en bout de finition

Schlicht Schafffräser

Finishing end mills

3331

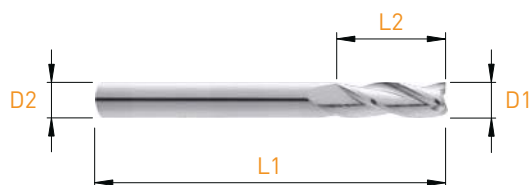

D1 e9	L2	D2 h6	L1	Art. N°	Z	TiAIN
2.00	8.00	2.00	32	3331-2.0	■	■
2.50	8.00	2.50	32	3331-2.5	■	■
3.00	12.00	3.00	32	3331-3.0	■	■
3.50	12.00	3.50	32	3331-3.5	■	■
4.00	12.00	4.00	40	3331-4.0	■	■
4.50	14.00	4.50	50	3331-4.5	■	■
5.00	14.00	5.00	50	3331-5.0	■	■
6.00	16.00	6.00	51	3331-6.0	■	■

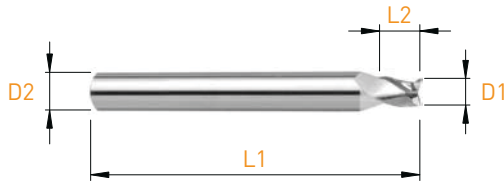

DHP

Denture à pas irrégulier, angle d'hélice progressif
 Ungleiche Teilung, progressive Drallwinkel
 Uneven tooth pitch, progressive helix angle

D1 h10	L2	D2 h6	L1	Art. N°	Z	TiAIN
1.00	4.00	6.00	40	DHP3336-1.0	■	■
1.50	4.00	6.00	40	DHP3336-1.5	■	■
2.00	4.00	6.00	40	DHP3336-2.0	■	■
2.50	4.00	6.00	40	DHP3336-2.5	■	■
3.00	5.00	6.00	40	DHP3336-3.0	■	■
3.50	5.00	6.00	40	DHP3336-3.5	■	■
4.00	6.00	6.00	40	DHP3336-4.0	■	■
5.00	7.00	6.00	40	DHP3336-5.0	■	■
6.00	8.00	6.00	40	DHP3336-6.0	■	■

Fraises en bout de finition

Schlicht Schafffräser

Finishing end mills

3341

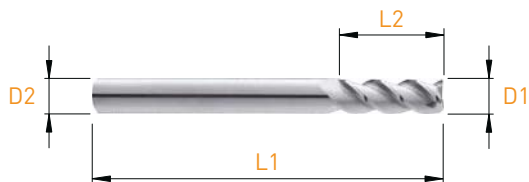

D1 e9	L2	D2 h6	L1	Art. N°	Z	TiAIN
2.00	8.00	2.00	32	3341-2.0	■	■
2.50	8.00	2.50	32	3341-2.5	■	■
3.00	12.00	3.00	32	3341-3.0	■	■
3.50	12.00	3.50	32	3341-3.5	■	■
4.00	12.00	4.00	40	3341-4.0	■	■
4.50	14.00	4.50	50	3341-4.5	■	■
5.00	14.00	5.00	50	3341-5.0	■	■
6.00	16.00	6.00	51	3341-6.0	■	■

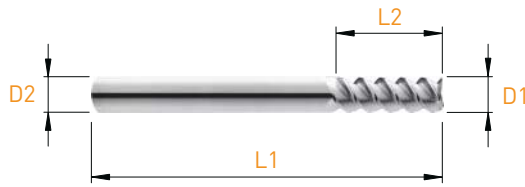

D1 e9	L2	D2 h6	L1	Art. N°	Z	TiAIN
2.00	8.00	2.00	32	3361-2.0	■	■
2.50	8.00	2.50	32	3361-2.5	■	■
3.00	12.00	3.00	32	3361-3.0	■	■
3.50	12.00	3.50	32	3361-3.5	■	■
4.00	12.00	4.00	40	3361-4.0	■	■
4.50	14.00	4.50	50	3361-4.5	■	■
5.00	14.00	5.00	50	3361-5.0	■	■
6.00	16.00	6.00	51	3361-6.0	■	■

Fraises en bout de finition

Schlicht Schafffräser

Finishing end mills

3430



D1 e9	L2	D2 h6	L1	Art. N°	Z	TiAIN
3.00	3.00	3.00	39	3430-3.0	■	■
4.00	4.00	4.00	50	3430-4.0	■	■
5.00	5.00	5.00	50	3430-5.0	■	■
6.00	6.00	6.00	51	3430-6.0	■	■

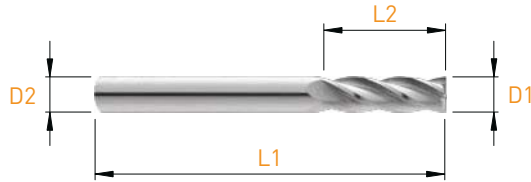

D1 _{e9}	L2	D2 _{h6}	L1	Art. N°	Z	TiAIN
2.00	8.00	2.00	32	3431-2.0	■	■
2.50	8.00	2.50	32	3431-2.5	■	■
3.00	12.00	3.00	32	3431-3.0	■	■
3.50	12.00	3.50	32	3431-3.5	■	■
4.00	12.00	4.00	40	3431-4.0	■	■
4.50	14.00	4.50	50	3431-4.5	■	■
5.00	14.00	5.00	50	3431-5.0	■	■
6.00	16.00	6.00	51	3431-6.0	■	■

Fraises en bout de finition

Schlicht Schafffräser

Finishing end mills

DHP3436

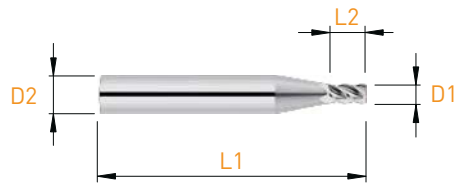

DHP

Denture à pas irrégulier, angle d'hélice progressive
 Ungleiche Teilung, progressive Drallwinkel
 Uneven tooth pitch, progressive helix angle

D1 h10	L2	D2 h6	L1	Art. N°	Z	TiAIN
1.00	4.00	6.00	40	DHP3436-1.0	■	■
1.50	4.00	6.00	40	DHP3436-1.5	■	■
2.00	4.00	6.00	40	DHP3436-2.0	■	■
2.50	4.00	6.00	40	DHP3436-2.5	■	■
3.00	5.00	6.00	40	DHP3436-3.0	■	■
3.50	5.00	6.00	40	DHP3436-3.5	■	■
4.00	6.00	6.00	40	DHP3436-4.0	■	■
5.00	7.00	6.00	40	DHP3436-5.0	■	■
6.00	8.00	6.00	40	DHP3436-6.0	■	■

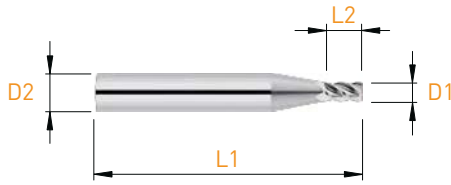

D1 h10	L2	D2 h6	L1	Art. N°	Z	TiAIN
1.00	2.00	6.00	40	3440-S-1.0	■	■
1.50	3.00	6.00	40	3440-S-1.5	■	■
2.00	4.00	6.00	40	3440-S-2.0	■	■
2.50	5.00	6.00	40	3440-S-2.5	■	■
3.00	6.00	6.00	40	3440-S-3.0	■	■
3.50	7.00	6.00	40	3440-S-3.5	■	■
4.00	8.00	6.00	40	3440-S-4.0	■	■
4.50	9.00	6.00	40	3440-S-4.5	■	■
5.00	10.00	6.00	40	3440-S-5.0	■	■
5.50	11.00	6.00	40	3440-S-5.5	■	■
6.00	12.00	6.00	40	3440-S-6.0	■	■

Fraises en bout de finition

Schlicht Schafffräser

Finishing end mills

3441

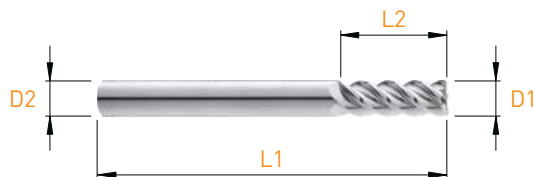

D1 e9	L2	D2 h6	L1	Art. N°	Z	TiAIN
2.00	8.00	2.00	32	3441-2.0	■	■
2.50	8.00	2.50	32	3441-2.5	■	■
3.00	12.00	3.00	32	3441-3.0	■	■
3.50	12.00	3.50	32	3441-3.5	■	■
4.00	12.00	4.00	40	3441-4.0	■	■
4.50	14.00	4.50	50	3441-4.5	■	■
5.00	14.00	5.00	50	3441-5.0	■	■
6.00	16.00	6.00	51	3441-6.0	■	■

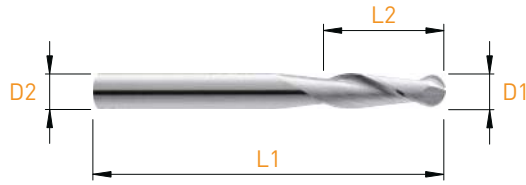

D1 e9	L2	D2 h6	L1	Art. N°	Z	TiAIN
2.00	8.00	2.00	32	3238-2.0	■	■
2.50	8.00	2.50	32	3238-2.5	■	■
3.00	12.00	3.00	32	3238-3.0	■	■
3.50	12.00	3.50	32	3238-3.5	■	■
4.00	12.00	4.00	40	3238-4.0	■	■
4.50	14.00	4.50	50	3238-4.5	■	■
5.00	14.00	5.00	50	3238-5.0	■	■
6.00	16.00	6.00	51	3238-6.0	■	■

Fraises en bout hémisphériques

Kugelschaftfräser

Ball nose end mills

3338

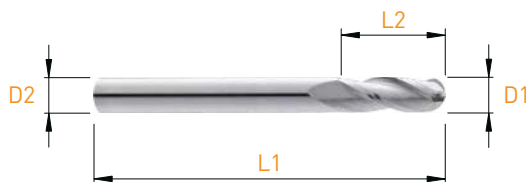

D1 _{e9}	L2	D2 _{h6}	L1	Art. N°	Z	TiAIN
2.00	8.00	2.00	32	3338-2.0	■	■
2.50	8.00	2.50	32	3338-2.5	■	■
3.00	12.00	3.00	32	3338-3.0	■	■
3.50	12.00	3.50	32	3338-3.5	■	■
4.00	12.00	4.00	40	3338-4.0	■	■
4.50	14.00	4.50	50	3338-4.5	■	■
5.00	14.00	5.00	50	3338-5.0	■	■
6.00	16.00	6.00	51	3338-6.0	■	■

Fraises en bout pour usinage en bout plat
 Schafffräser für flache Frontbearbeitung
 End mills for flat front machining

3383

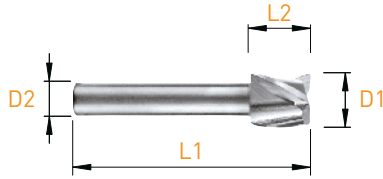

Sharp Corner	Z=3		$\lambda 30^\circ$		MD VHM HM
--------------	-----	--	--------------------	--	-----------------

D1 h10	L2	D2 h6	L1	Art. N°	Z
8.00	8.00	6.00	40	3383-8.0	■
10.00	10.00	6.00	40	3383-10.0	■
12.00	12.00	6.00	40	3383-12.0	■

Fraises en bout avec queue réduite

Schafffräser mit reduziertem Schaft

End mills with reduced shank

3831 / 3833

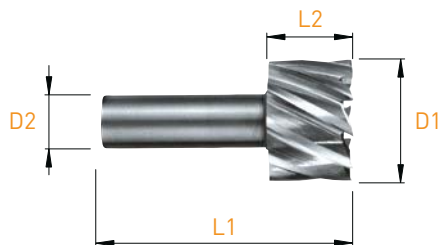

D1 h10	L2	D2 h6	L1	Art. N°	z
16.30	15.00	10.00	45	3831	■
20.30	15.00	10.00	45	3833	■

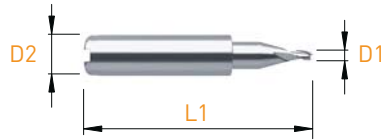

Z=3

Sharp
Corner

1xD1

Disponible tous les 0.1 mm
Verfügbar jede 0.1 mm
Available each 0.1 mm

D1	L2	D2 h5	L1	Art. N°	Z	TiAlN	TiCN	DLC53
0.30	0.30	6.00	33	701S3371-1-0.30	■	□	□	□
⋮	⋮	⋮	⋮	⋮	⋮	⋮	⋮	⋮
3.50	3.50	6.00	33	701S3371-1-3.50	■	□	□	□



Z=3

Sharp
Corner

2xD1

Disponible tous les 0.1 mm
Verfügbar jede 0.1 mm
Available each 0.1 mm

D1	L2	D2 h5	L1	Art. N°	Z	TiAlN	TiCN	DLC53
0.30	0.60	6.00	33	701S3371-2-0.30	■	□	□	□
⋮	⋮	⋮	⋮	⋮	⋮	⋮	⋮	⋮
3.50	7.00	6.00	33	701S3371-2-3.50	■	□	□	□



Z=3

Sharp
Corner

3xD1

Disponible tous les 0.1 mm
Verfügbar jede 0.1 mm
Available each 0.1 mm

D1	L2	D2 h5	L1	Art. N°	Z	TiAlN	TiCN	DLC53
0.30	0.90	6.00	33	701S3371-3-0.30	■	□	□	□
⋮	⋮	⋮	⋮	⋮	⋮	⋮	⋮	⋮
3.00	9.00	6.00	33	701S3371-3-3.00	■	□	□	□

Autres outils pour machine WM 701S

Andere Werkzeuge für Maschine WM 701S

Other executions for machine WM 701S



Tous les outils de la gamme MICRO-Line sont réalisables pour la machine WM 701S sur demande.

Alle Werkzeuge aus der MICRO-Line sind machbar für die Maschine WM 701S auf Anfrage.

All tools of MICRO-Line can be produced for the machine WM 701S on request.



Z=3

λ^{90°



MD
VHM
HM

D1	L2	D2 _{h4}	L1	d	Art. N°	Z	TiAlN
0.50	3.00	3.00	39	0.10	3911-0.5	■	
0.60	3.00	3.00	39	0.10	3911-0.6	■	
0.70	3.00	3.00	39	0.10	3911-0.7	■	
0.80	3.00	3.00	39	0.10	3911-0.8	■	
0.90	3.00	3.00	39	0.10	3911-0.9	■	
1.00	3.00	3.00	39	0.10	3911-1.0	■	
1.50	4.50	3.00	39	0.10	3911-1.5	■	
2.00	6.00	3.00	39	0.10	3911-2.0	■	■
2.50	7.50	3.00	39	0.10	3911-2.5	■	■
3.00	-	3.00	39	0.10	3911-3.0	■	■

Fraises à angler

Kegelsenker

Chamfering tools

1901 / 3901

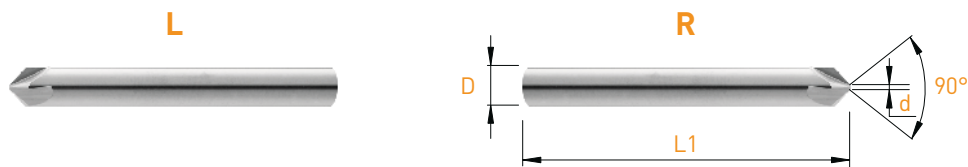

Z=4 λ^{0°  MD VHM HM				L		R	
D _{h6}	d	L1	Art. N°	z	Art. N°	z	TiAlN
3.00	0.30	39	1901-3.0	■	3901-3.0	■	■
6.00	0.70	50	1901-6.0	■	3901-6.0	■	■
8.00	1.20	59	1901-8.0	■	3901-8.0	■	■

	Angle Winkel Angle	Plat [a] / Rayon [r] Fläche [a] / Radius [r] Flat [a] / Radius [r]	Corps Schaft Shank	Type Typ Type	Page Seite Page
Fraises à graver avec plat Gravierfräser mit Fläche Engraving mills with flat	20° / 30° / 35° / 40° 45° / 50° / 55° / 60° 65° / 70° / 90°	a= 0.02-0.10 / every 0.01 0.10-0.30 / every 0.05	Ø3h4	E300-P	13.61
Fraises à graver à rayon Gravierfräser mit Radius Engraving mills with radius	20° / 30° / 35° / 40° 45° / 50° / 55° / 60° 65° / 70° / 90°	r= 0.02-0.10 / every 0.01 0.10-0.30 / every 0.05	Ø3h4	E300-R	13.62
Fraises à graver renforcées Verstärkte Gravierfräser Reinforced engraving	20° / 30° / 35° / 40° 45° / 50° / 55° / 60° 65° / 70° / 90°	a= 0.02-0.10 / every 0.01 0.10-0.30 / every 0.05	Ø3h4	E900-P	13.63

Matière Werkstoff Material		Vf [mm/min]*	Non revêtu Unbeschichtet Uncoated	Revêtu Beschichtet Coated	
Acier Stahl Steel	< 700 N/mm ²	P	80 - 180	-	++
Acier Stahl Steel	> 700 N/mm ²	P	70 - 150	+	++
Acier inoxydable Rostfreistahl Stainless steel		M	70 - 150	-	++
Aluminium		N	80 - 250	++	-
Cuivre Kupfer Copper		N	70 - 150	+	++
Laiton Messing Brass		N	80 - 200	++	-
Or Gold Gold		N	80 - 200	++	+
Titane Titan Titanium		S	70 - 130	++	+

* Avance conseillée pour des vitesses de rotation entre 20'000 et 30'000 tours/min
 * Empfohlener Vorschub für Drehgeschwindigkeiten zwischen 20'000 und 30'000 U/Min
 * Recommended feed rate for rotation speed between 20'000 and 30'000 RPM

Fraises à graver avec plat

Gravierfräser mit Fläche

Engraving mills with flat

E300-P

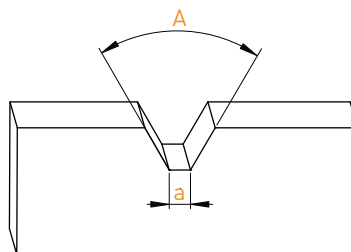
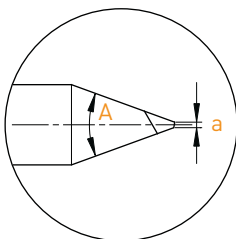
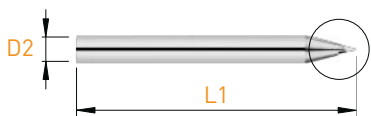

MD
VHM
HM

A	a	D2 h4	L1	Art. N°	Z	TiAIN	TiCN	DLC53
20°	0.02-0.10* / 0.10-0.30**	3.00	33	E320-P-_ (a)	■	■	■	□
30°	0.02-0.10* / 0.10-0.30**	3.00	33	E330-P-_ (a)	■	■	■	□
35°	0.02-0.10* / 0.10-0.30**	3.00	33	E335-P-_ (a)	■	■	■	□
40°	0.02-0.10* / 0.10-0.30**	3.00	33	E340-P-_ (a)	■	■	■	□
45°	0.02-0.10* / 0.10-0.30**	3.00	33	E345-P-_ (a)	■	■	■	□
50°	0.02-0.10* / 0.10-0.30**	3.00	33	E350-P-_ (a)	■	■	■	□
55°	0.02-0.10* / 0.10-0.30**	3.00	33	E355-P-_ (a)	■	■	■	□
60°	0.02-0.10* / 0.10-0.30**	3.00	33	E360-P-_ (a)	■	■	■	□
65°	0.02-0.10* / 0.10-0.30**	3.00	33	E365-P-_ (a)	■	■	■	□
70°	0.02-0.10* / 0.10-0.30**	3.00	33	E370-P-_ (a)	■	■	■	□
90°	0.02-0.10* / 0.10-0.30**	3.00	33	E390-P-_ (a)	■	■	■	□

* tous les 0.01 mm
alle 0.01 mm
every 0.01 mm

** tous les 0.05 mm
alle 0.05 mm
every 0.05 mm

MICRO-LINE

Fraises à graver à rayon

Gravierfräser mit Radius

Engraving mills with radius

E300-R

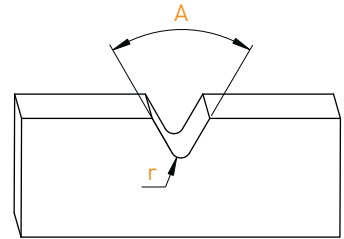
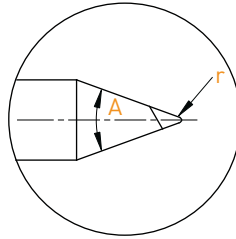
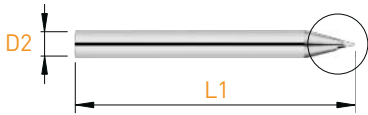

MD
VHM
HM

A	r	D2 h4	L1	Art. N°	Z	TiAIN	TiCN	DLC53
20°	0.04-0.10* / 0.10-0.30**	3.00	33	E320-R-_(r)	■	■	■	□
30°	0.04-0.10* / 0.10-0.30**	3.00	33	E330-R-_(r)	■	■	■	□
35°	0.04-0.10* / 0.10-0.30**	3.00	33	E335-R-_(r)	■	■	■	□
40°	0.04-0.10* / 0.10-0.30**	3.00	33	E340-R-_(r)	■	■	■	□
45°	0.04-0.10* / 0.10-0.30**	3.00	33	E345-R-_(r)	■	■	■	□
50°	0.04-0.10* / 0.10-0.30**	3.00	33	E350-R-_(r)	■	■	■	□
55°	0.04-0.10* / 0.10-0.30**	3.00	33	E355-R-_(r)	■	■	■	□
60°	0.04-0.10* / 0.10-0.30**	3.00	33	E360-R-_(r)	■	■	■	□
65°	0.04-0.10* / 0.10-0.30**	3.00	33	E365-R-_(r)	■	■	■	□
70°	0.04-0.10* / 0.10-0.30**	3.00	33	E370-R-_(r)	■	■	■	□
90°	0.04-0.10* / 0.10-0.30**	3.00	33	E390-R-_(r)	■	■	■	□

* tous les 0.01 mm
alle 0.01 mm
every 0.01 mm

** tous les 0.05 mm
alle 0.05 mm
every 0.05 mm

Fraises à graver renforcées

Verstärkte Gravierfräser

Reinforced engraving mills

E900-P

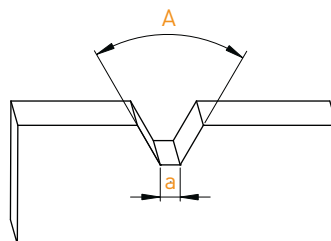
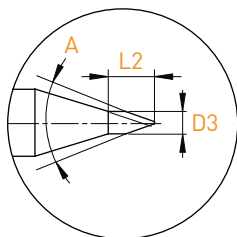
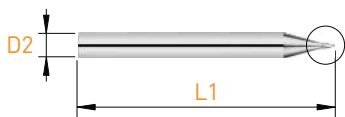

MD
VHM
HM

A	a	D3	L2	D2 h4	L1	Art. N°	Z	TiAlN	TiCN	DLC53
20°	0.04-0.10* / 0.10-0.30**	0.60	1.80	3.00	33	E920-P-_ (a)	■	■	■	□
30°	0.04-0.10* / 0.10-0.30**	0.60	1.80	3.00	33	E930-P-_ (a)	■	■	■	□
35°	0.04-0.10* / 0.10-0.30**	0.60	1.80	3.00	33	E935-P-_ (a)	■	■	■	□
40°	0.04-0.10* / 0.10-0.30**	0.60	1.80	3.00	33	E940-P-_ (a)	■	■	■	□
45°	0.04-0.10* / 0.10-0.30**	1.00	1.80	3.00	33	E945-P-_ (a)	■	■	■	□
50°	0.04-0.10* / 0.10-0.30**	1.00	2.00	3.00	33	E950-P-_ (a)	■	■	■	□
55°	0.04-0.10* / 0.10-0.30**	1.00	2.00	3.00	33	E955-P-_ (a)	■	■	■	□
60°	0.04-0.10* / 0.10-0.30**	1.20	2.00	3.00	33	E960-P-_ (a)	■	■	■	□
65°	0.04-0.10* / 0.10-0.30**	1.20	2.00	3.00	33	E965-P-_ (a)	■	■	■	□
70°	0.04-0.10* / 0.10-0.30**	1.20	2.00	3.00	33	E970-P-_ (a)	■	■	■	□
90°	0.04-0.10* / 0.10-0.30**	1.20	2.00	3.00	33	E990-P-_ (a)	■	■	■	□

* tous les 0.01 mm
alle 0.01 mm
every 0.01 mm

** tous les 0.05 mm
alle 0.05 mm
every 0.05 mm

Micro-forets / Centreurs NC
Mikrobohrer / NC-Zentrierbohrer
Micro drills / NC centering drills

Paramètres de coupe indicatifs
Empfohlene Schnittwerte
Standard machining data

Matière Werkstoff Material	VC (m/min)	f [mm/U]			
		Ø 0.4 - 0.6	Ø 0.6 - 1.0	Ø 1.0 - 3.0	Ø 3.0 - 6.0
Acier Stahl Steel < 700 N/mm ² P	60 - 100	0.004 - 0.008	0.006 - 0.015	0.010 - 0.040	0.040 - 0.100
Acier Stahl Steel > 700 N/mm ² P	30 - 60	0.003 - 0.005	0.005 - 0.012	0.010 - 0.040	0.040 - 0.080
Acier inoxydable Rostfreistahl Stainless steel M	30 - 60	0.003 - 0.006	0.005 - 0.012	0.010 - 0.040	0.040 - 0.080
Aluminium N	60 - 150	0.004 - 0.010	0.006 - 0.030	0.020 - 0.070	0.050 - 0.150
Cuivre Kupfer Copper N	50 - 80	0.004 - 0.012	0.007 - 0.020	0.050 - 0.060	0.050 - 0.120
Laiton Messing Brass N	60 - 100	0.005 - 0.015	0.008 - 0.030	0.020 - 0.070	0.060 - 0.150
Or Gold Gold N	50 - 100	0.004 - 0.010	0.006 - 0.030	0.020 - 0.070	0.060 - 0.150
Titane Titan Titanium S	25 - 50	0.002 - 0.005	0.004 - 0.010	0.008 - 0.030	0.030 - 0.070

Micro-forets et centreurs NC

Mikrobohrer und NC-Zentrierbohrer

Micro drills and NC centering drills

Micro-forets et centreurs Mikrobohrer und Zentrierbohrer Micro drills and centering drills							
Point angle	Helix	L2	Range	Increments	Shank	Type	page
60°	25°	-	Ø 2.00 - 6.00	1.00	D1 = D2	2680-60	13.66
90°	25°	-	Ø 0.50 - 20.00	0.10 +	Ø 2.0 - 20.0	2680-90	13.67
90°	L 25°	-	Ø 2.00 - 16.00	0.50 +	D1 = D2	1680-90	13.67
120°	25°	-	Ø 0.50 - 20.00	0.10 +	Ø 2.0 - 20.0	2680-120	13.68
120°	L 25°	-	Ø 2.00 - 12.00	0.50 +	D1 = D2	1680-120	13.68

Micro-forets de préperçage Mikro Pilotbohrer Micro pilot drill							
Point angle	Helix	L2	Range	Increments	Shank	Type	page
90°	32°	-	Ø 0.50 - 3.00	0.10	Ø 2.0 - 3.0	2690	13.69
130°	30°	2 x D1	Ø 0.10 - 2.00	0.01	Ø 3.0	2020	13.70

Micro-forets avec affûtage à facettes Mikrobohrer mit Facettenschliff Micro drills with faceted drill point							
Point angle	Helix	L2	Range	Increments	Shank	Type	page
120°	L 30°	~ 5-10 x D1	Ø 0.50 - 6.00	0.05 - 0.10	D1 = D2	1010	13.72
120°	30°	~ 5-10 x D1	Ø 0.50 - 6.00	0.05 - 0.10	D1 = D2	2010	13.73
120°	35°	~ 2 x D1	Ø 0.80 - 2.00	0.10 +	Ø 2.0	2011	13.74
120°	24°	~ 3 x D1	Ø 0.50 - 2.40	0.05 - 0.10	Ø 1.5 - 2.5	2012	13.74
120°	35°	~ 8 x D1	Ø 0.40 - 1.90	0.05 - 0.10	Ø 1.0 - 2.0	2013	13.75
120°	30°	~ 12 x D1	Ø 0.50 - 1.95	0.05	Ø 1.5 - 2.0	2014	13.75
130°	35°	6 x D1	Ø 0.10 - 3.00	0.01	Ø 3.0	2023	13.76
130°	25°	12 x D1	Ø 0.20 - 2.00	0.01	Ø 3.0	2026	13.79
140°	Z=3 35°	5 x D1	Ø 0.20 - 2.99	0.01	Ø 3.0	2030	13.81

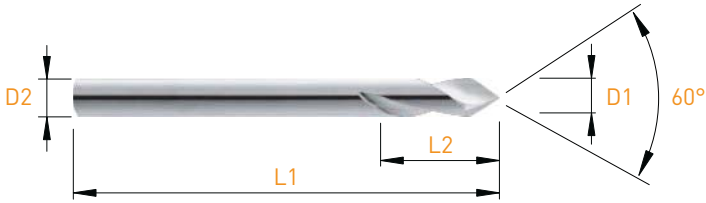

60° λ^{25° MD
VHM
HM

D1 _{h6}	L2	D2 _{h4}	L1	Art. N°	Z	TiAlN
2.00	8.00	2.00	39	2680-2.00-60	■	■
3.00	10.00	3.00	39	2680-3.00-60	■	■
4.00	12.00	4.00	50	2680-4.00-60	■	■
5.00	14.00	5.00	50	2680-5.00-60	■	■
6.00	16.00	6.00	50	2680-6.00-60	■	■

Centreurs NC
NC-Zentrierbohrer
NC centering drills

1680-90° / 2680-90°

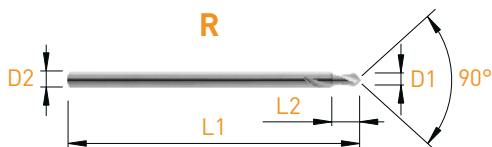

90°	λ 25°	MD VHM HM	R		
D1 h6	L2	D2 h6	L1	Art. N°	Z
0.50	1.50	2.00	39	2680-0.50-90	■
0.60	1.50	2.00	39	2680-0.60-90	■
0.70	1.50	2.00	39	2680-0.70-90	■
0.80	1.50	2.00	39	2680-0.80-90	■
0.90	1.50	2.00	39	2680-0.90-90	■
1.00	3.00	2.00	39	2680-1.00-90	■
1.10	3.00	2.00	39	2680-1.10-90	■
1.20	3.00	2.00	39	2680-1.20-90	■
1.30	3.00	2.00	39	2680-1.30-90	■
1.40	3.00	2.00	39	2680-1.40-90	■
1.50	4.00	2.00	39	2680-1.50-90	■
1.60	4.00	2.00	39	2680-1.60-90	■
1.70	4.00	2.00	39	2680-1.70-90	■
1.80	4.00	2.00	39	2680-1.80-90	■
1.90	4.00	2.00	39	2680-1.90-90	■

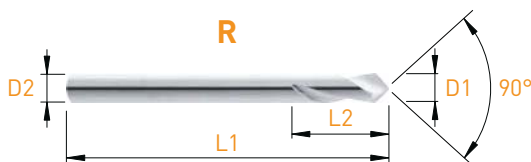

90°	λ 25°	MD VHM HM	L		R		HSS	R	
D1=D2 h6	L2	L1	Art. N°	Z	Art. N°	Z	TITAIN	Art. N°	Z
2.00	8.00	39	1680-2.00-90	■	2680-2.00-90	■ ■		-	
2.50	8.00	39	1680-2.50-90	■	2680-2.50-90	■ ■		-	
3.00	10.00	39	1680-3.00-90	■	2680-3.00-90	■ ■		2680-3.00-90-HSS	□
4.00	12.00	50	1680-4.00-90	■	2680-4.00-90	■ ■		2680-4.00-90-HSS	□
5.00	15.00	50	1680-5.00-90	■	2680-5.00-90	■ ■		2680-5.00-90-HSS	□
6.00	16.00	57	1680-6.00-90	■	2680-6.00-90	■ ■		2680-6.00-90-HSS	□
8.00	20.00	63	1680-8.00-90	■	2680-8.00-90	■		2680-8.00-90-HSS	□
10.00	22.00	72	1680-10.00-90	□	2680-10.00-90	□		2680-10.00-90-HSS	□
12.00	24.00	73	1680-12.00-90	□	2680-12.00-90	□		2680-12.00-90-HSS	□
16.00	26.00	82	1680-16.00-90	□	2680-16.00-90	□		-	
20.00	30.00	92	-		2680-20.00-90	□		-	

■ = disponible / verfügbar / available
□ = selon disponibilité du stock / jenach Lagerverfügbarkeit / depending on stock availability

MICRO-LINE

Centreurs NC
 NC-Zentrierbohrer
 NC centering drills

1680-120° / 2680-120°

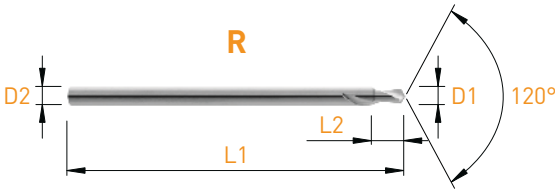

120°	λ^{25°	MD VHM HM	R			
D1 h6	L2	D2 h6	L1	Art. N°	Z	
0.50	1.50	2.00	39	2680-0.50-120	■	
0.60	1.50	2.00	39	2680-0.60-120	■	
0.70	1.50	2.00	39	2680-0.70-120	■	
0.80	1.50	2.00	39	2680-0.80-120	■	
0.90	1.50	2.00	39	2680-0.90-120	■	
1.00	3.00	2.00	39	2680-1.00-120	■	
1.10	3.00	2.00	39	2680-1.10-120	■	
1.20	3.00	2.00	39	2680-1.20-120	■	
1.30	3.00	2.00	39	2680-1.30-120	■	
1.40	3.00	2.00	39	2680-1.40-120	■	
1.50	4.00	2.00	39	2680-1.50-120	■	
1.60	4.00	2.00	39	2680-1.60-120	■	
1.70	4.00	2.00	39	2680-1.70-120	■	
1.80	4.00	2.00	39	2680-1.80-120	■	
1.90	4.00	2.00	39	2680-1.90-120	■	

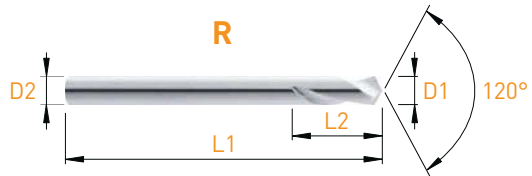

120°	λ^{25°	MD VHM HM	L		R		
D1=D2 h6	L2	L1	Art. N°	Z	Art. N°	Z	TiAIN
2.00	8.00	39	1680-2.00-120	■	2680-2.00-120	■	■
2.50	8.00	39	1680-2.50-120	■	2680-2.50-120	■	■
3.00	10.00	39	1680-3.00-120	■	2680-3.00-120	■	■
4.00	12.00	50	1680-4.00-120	■	2680-4.00-120	■	■
5.00	15.00	50	1680-5.00-120	■	2680-5.00-120	■	■
6.00	16.00	57	1680-6.00-120	■	2680-6.00-120	■	■
8.00	20.00	63	1680-8.00-120	■	2680-8.00-120	■	■
10.00	22.00	72	1680-10.00-120	□	2680-10.00-120	□	■
12.00	24.00	73	1680-12.00-120	□	2680-12.00-120	□	■
16.00	26.00	82	-		2680-16.00-120	□	■
20.00	30.00	92	-		2680-20.00-120	□	■

Micro-forets de préperçage

Mikro Pilotbohrer

Micro pilot drill

2690

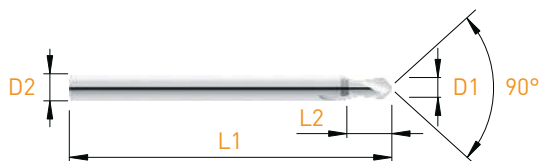

90° λ^{32° MD VHM HM

D1 h6	L2	D2 h4	L1	Art. N°	Z	TIALIN
0.50*	2.50	2	39	2690-0.50	■	
0.60*	2.50	2	39	2690-0.60	■	
0.70*	2.50	2	39	2690-0.70	■	
0.80*	2.50	2	39	2690-0.80	■	
0.90*	2.50	2	39	2690-0.90	■	
1.00	3.00	2	39	2690-1.00	■	
1.10	3.00	2	39	2690-1.10	■	
1.20	3.00	2	39	2690-1.20	■	
1.30	3.00	2	39	2690-1.30	■	
1.40	3.00	2	39	2690-1.40	■	
1.50	3.50	2	39	2690-1.50	■	
1.60	3.50	2	39	2690-1.60	■	
1.70	3.50	2	39	2690-1.70	■	
1.80	3.50	2	39	2690-1.80	■	
1.90	3.50	2	39	2690-1.90	■	
2.00	-	2	39	2690-2.00	■	■
2.10	4.00	3	39	2690-2.10	■	■
2.20	4.00	3	39	2690-2.20	■	■
2.30	4.00	3	39	2690-2.30	■	■
2.40	4.00	3	39	2690-2.40	■	■
2.50	4.00	3	39	2690-2.50	■	■
2.60	4.00	3	39	2690-2.60	■	■
2.70	4.00	3	39	2690-2.70	■	■
2.80	4.00	3	39	2690-2.80	■	■
2.90	4.00	3	39	2690-2.90	■	■
3.00	-	3	50	2690-3.00	■	■

* λ^{25°

MICRO-LINE

Micro-forets de préperçage

Mikro Pilotbohrer

Micro pilot drill

Ø 0.10 - Ø 0.99 mm

2020

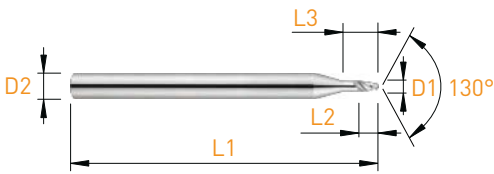

130°	λ^{30°	Z=2	2xD1		MD VHM HM
------	----------------------	-----	------	--	-----------------

D1 0/+0.005	L2	L3	L1	D2 h6	Art. N°	z
0.10	0.35	0.55	38	3.00	2020-0.10	■
0.11	0.35	0.55	38	3.00	2020-0.11	■
0.12	0.35	0.55	38	3.00	2020-0.12	■
0.13	0.40	0.60	38	3.00	2020-0.13	■
0.14	0.40	0.60	38	3.00	2020-0.14	■
0.15	0.40	0.60	38	3.00	2020-0.15	■
0.16	0.40	0.60	38	3.00	2020-0.16	■
0.17	0.50	0.70	38	3.00	2020-0.17	■
0.18	0.50	0.70	38	3.00	2020-0.18	■
0.19	0.50	0.70	38	3.00	2020-0.19	■
0.20	0.55	0.75	38	3.00	2020-0.20	■
0.21	0.55	0.75	38	3.00	2020-0.21	■
0.22	0.60	0.80	38	3.00	2020-0.22	■
0.23	0.60	0.80	38	3.00	2020-0.23	■
0.24	0.60	0.80	38	3.00	2020-0.24	■
0.25	0.70	0.90	38	3.00	2020-0.25	■
0.26	0.70	0.90	38	3.00	2020-0.26	■
0.27	0.70	0.90	38	3.00	2020-0.27	■
0.28	0.80	1.00	38	3.00	2020-0.28	■
0.29	0.80	1.00	38	3.00	2020-0.29	■
0.30	0.90	1.20	38	3.00	2020-0.30	■
0.31	0.90	1.20	38	3.00	2020-0.31	■
0.32	0.90	1.20	38	3.00	2020-0.32	■
0.33	0.90	1.20	38	3.00	2020-0.33	■
0.34	0.90	1.35	38	3.00	2020-0.34	■
0.35	0.90	1.35	38	3.00	2020-0.35	■
0.36	0.95	1.35	38	3.00	2020-0.36	■
0.37	0.95	1.35	38	3.00	2020-0.37	■
0.38	0.95	1.50	38	3.00	2020-0.38	■
0.39	0.95	1.50	38	3.00	2020-0.39	■
0.40	0.80	1.60	38	3.00	2020-0.40	■
0.41	0.82	1.60	38	3.00	2020-0.41	■
0.42	0.84	1.60	38	3.00	2020-0.42	■
0.43	0.86	1.60	38	3.00	2020-0.43	■
0.44	0.88	1.60	38	3.00	2020-0.44	■
0.45	0.90	1.60	38	3.00	2020-0.45	■
0.46	0.92	1.70	38	3.00	2020-0.46	■
0.47	0.94	1.70	38	3.00	2020-0.47	■
0.48	0.96	1.70	38	3.00	2020-0.48	■

D1 0/+0.005	L2	L3	L1	D2 h6	Art. N°	z
0.49	0.98	1.70	38	3.00	2020-0.49	■
0.50	1.00	1.70	38	3.00	2020-0.50	■
0.51	1.02	1.80	38	3.00	2020-0.51	■
0.52	1.04	1.80	38	3.00	2020-0.52	■
0.53	1.06	1.80	38	3.00	2020-0.53	■
0.54	1.08	1.80	38	3.00	2020-0.54	■
0.55	1.10	1.80	38	3.00	2020-0.55	■
0.56	1.12	1.90	38	3.00	2020-0.56	■
0.57	1.14	1.90	38	3.00	2020-0.57	■
0.58	1.16	1.90	38	3.00	2020-0.58	■
0.59	1.18	1.90	38	3.00	2020-0.59	■
0.60	1.20	1.90	38	3.00	2020-0.60	■
0.61	1.22	2.00	38	3.00	2020-0.61	■
0.62	1.24	2.00	38	3.00	2020-0.62	■
0.63	1.26	2.00	38	3.00	2020-0.63	■
0.64	1.28	2.00	38	3.00	2020-0.64	■
0.65	1.30	2.00	38	3.00	2020-0.65	■
0.66	1.32	2.10	38	3.00	2020-0.66	■
0.67	1.34	2.10	38	3.00	2020-0.67	■
0.68	1.36	2.10	38	3.00	2020-0.68	■
0.69	1.38	2.10	38	3.00	2020-0.69	■
0.70	1.40	2.10	38	3.00	2020-0.70	■
0.71	1.42	2.20	38	3.00	2020-0.71	■
0.72	1.44	2.20	38	3.00	2020-0.72	■
0.73	1.46	2.20	38	3.00	2020-0.73	■
0.74	1.48	2.20	38	3.00	2020-0.74	■
0.75	1.50	2.20	38	3.00	2020-0.75	■
0.76	1.52	2.30	38	3.00	2020-0.76	■
0.77	1.54	2.30	38	3.00	2020-0.77	■
0.78	1.56	2.30	38	3.00	2020-0.78	■
0.79	1.58	2.30	38	3.00	2020-0.79	■
0.80	1.60	2.30	38	3.00	2020-0.80	■
0.81	1.62	2.40	38	3.00	2020-0.81	■
0.82	1.64	2.40	38	3.00	2020-0.82	■
0.83	1.66	2.40	38	3.00	2020-0.83	■
0.84	1.68	2.40	38	3.00	2020-0.84	■
0.85	1.70	2.40	38	3.00	2020-0.85	■
0.86	1.72	2.50	38	3.00	2020-0.86	■
0.87	1.74	2.50	38	3.00	2020-0.87	■
0.88	1.76	2.50	38	3.00	2020-0.88	■
0.89	1.78	2.50	38	3.00	2020-0.89	■
0.90	1.80	2.50	38	3.00	2020-0.90	■
0.91	1.82	2.60	38	3.00	2020-0.91	■
0.92	1.84	2.60	38	3.00	2020-0.92	■
0.93	1.86	2.60	38	3.00	2020-0.93	■
0.94	1.88	2.60	38	3.00	2020-0.94	■
0.95	1.90	2.60	38	3.00	2020-0.95	■
0.96	1.92	2.70	38	3.00	2020-0.96	■
0.97	1.94	2.70	38	3.00	2020-0.97	■
0.98	1.96	2.70	38	3.00	2020-0.98	■
0.99	1.98	2.70	38	3.00	2020-0.99	■

Micro-forets de préperçage

Mikro Pilotbohrer

Micro pilot drill

Ø 1.00 - Ø 2.00 mm

2020

D1 0/+0.005	L2	L3	L1	D2 h6	Art. N°	Z
1.00	2.00	2.70	38	3.00	2020-1.00	■
1.01	2.02	3.50	38	3.00	2020-1.01	■
1.02	2.04	3.50	38	3.00	2020-1.02	■
1.03	2.06	3.50	38	3.00	2020-1.03	■
1.04	2.08	3.50	38	3.00	2020-1.04	■
1.05	2.10	3.50	38	3.00	2020-1.05	■
1.06	2.12	3.60	38	3.00	2020-1.06	■
1.07	2.14	3.60	38	3.00	2020-1.07	■
1.08	2.16	3.60	38	3.00	2020-1.08	■
1.09	2.18	3.60	38	3.00	2020-1.09	■
1.10	2.20	3.60	38	3.00	2020-1.10	■
1.11	2.22	3.70	38	3.00	2020-1.11	■
1.12	2.24	3.70	38	3.00	2020-1.12	■
1.13	2.26	3.70	38	3.00	2020-1.13	■
1.14	2.28	3.70	38	3.00	2020-1.14	■
1.15	2.30	3.70	38	3.00	2020-1.15	■
1.16	2.32	3.80	38	3.00	2020-1.16	■
1.17	2.34	3.80	38	3.00	2020-1.17	■
1.18	2.36	3.80	38	3.00	2020-1.18	■
1.19	2.38	3.80	38	3.00	2020-1.19	■
1.20	2.40	3.80	38	3.00	2020-1.20	■
1.21	2.42	4.20	38	3.00	2020-1.21	■
1.22	2.44	4.20	38	3.00	2020-1.22	■
1.23	2.46	4.20	38	3.00	2020-1.23	■
1.24	2.48	4.20	38	3.00	2020-1.24	■
1.25	2.50	4.20	38	3.00	2020-1.25	■
1.26	2.52	4.30	38	3.00	2020-1.26	■
1.27	2.54	4.30	38	3.00	2020-1.27	■
1.28	2.56	4.30	38	3.00	2020-1.28	■
1.29	2.58	4.30	38	3.00	2020-1.29	■
1.30	2.60	4.30	38	3.00	2020-1.30	■
1.31	2.62	4.40	38	3.00	2020-1.31	■
1.32	2.64	4.40	38	3.00	2020-1.32	■
1.33	2.66	4.40	38	3.00	2020-1.33	■
1.34	2.68	4.40	38	3.00	2020-1.34	■
1.35	2.70	4.40	38	3.00	2020-1.35	■
1.36	2.72	4.50	38	3.00	2020-1.36	■
1.37	2.74	4.50	38	3.00	2020-1.37	■
1.38	2.76	4.50	38	3.00	2020-1.38	■
1.39	2.78	4.50	38	3.00	2020-1.39	■
1.40	2.80	4.50	38	3.00	2020-1.40	■
1.41	2.82	4.60	38	3.00	2020-1.41	■
1.42	2.84	4.60	38	3.00	2020-1.42	■
1.43	2.86	4.60	38	3.00	2020-1.43	■
1.44	2.88	4.60	38	3.00	2020-1.44	■
1.45	2.90	4.60	38	3.00	2020-1.45	■
1.46	2.92	4.70	38	3.00	2020-1.46	■
1.47	2.94	4.70	38	3.00	2020-1.47	■
1.48	2.96	4.70	38	3.00	2020-1.48	■
1.49	2.98	4.70	38	3.00	2020-1.49	■
1.50	3.00	4.70	38	3.00	2020-1.50	■

D1 0/+0.005	L2	L3	L1	D2 h6	Art. N°	Z
1.51	3.02	5.10	38	3.00	2020-1.51	■
1.52	3.04	5.10	38	3.00	2020-1.52	■
1.53	3.06	5.10	38	3.00	2020-1.53	■
1.54	3.08	5.10	38	3.00	2020-1.54	■
1.55	3.10	5.10	38	3.00	2020-1.55	■
1.56	3.12	5.20	38	3.00	2020-1.56	■
1.57	3.14	5.20	38	3.00	2020-1.57	■
1.58	3.16	5.20	38	3.00	2020-1.58	■
1.59	3.18	5.20	38	3.00	2020-1.59	■
1.60	3.20	5.20	38	3.00	2020-1.60	■
1.61	3.22	5.30	38	3.00	2020-1.61	■
1.62	3.24	5.30	38	3.00	2020-1.62	■
1.63	3.26	5.30	38	3.00	2020-1.63	■
1.64	3.28	5.30	38	3.00	2020-1.64	■
1.65	3.30	5.30	38	3.00	2020-1.65	■
1.66	3.32	5.40	38	3.00	2020-1.66	■
1.67	3.34	5.40	38	3.00	2020-1.67	■
1.68	3.36	5.40	38	3.00	2020-1.68	■
1.69	3.38	5.40	38	3.00	2020-1.69	■
1.70	3.40	5.40	38	3.00	2020-1.70	■
1.71	3.42	5.50	38	3.00	2020-1.71	■
1.72	3.44	5.50	38	3.00	2020-1.72	■
1.73	3.46	5.50	38	3.00	2020-1.73	■
1.74	3.48	5.50	38	3.00	2020-1.74	■
1.75	3.50	5.50	38	3.00	2020-1.75	■
1.76	3.52	5.60	38	3.00	2020-1.76	■
1.77	3.54	5.60	38	3.00	2020-1.77	■
1.78	3.56	5.60	38	3.00	2020-1.78	■
1.79	3.58	5.60	38	3.00	2020-1.79	■
1.80	3.60	5.60	38	3.00	2020-1.80	■
1.81	3.62	5.70	38	3.00	2020-1.81	■
1.82	3.64	5.70	38	3.00	2020-1.82	■
1.83	3.66	5.70	38	3.00	2020-1.83	■
1.84	3.68	5.70	38	3.00	2020-1.84	■
1.85	3.70	5.70	38	3.00	2020-1.85	■
1.86	3.72	5.80	38	3.00	2020-1.86	■
1.87	3.74	5.80	38	3.00	2020-1.87	■
1.88	3.76	5.80	38	3.00	2020-1.88	■
1.89	3.78	5.80	38	3.00	2020-1.89	■
1.90	3.80	5.80	38	3.00	2020-1.90	■
1.91	3.82	5.90	38	3.00	2020-1.91	■
1.92	3.84	5.90	38	3.00	2020-1.92	■
1.93	3.86	5.90	38	3.00	2020-1.93	■
1.94	3.88	5.90	38	3.00	2020-1.94	■
1.95	3.90	5.90	38	3.00	2020-1.95	■
1.96	3.92	6.00	38	3.00	2020-1.96	■
1.97	3.94	6.00	38	3.00	2020-1.97	■
1.98	3.96	6.00	38	3.00	2020-1.98	■
1.99	3.98	6.00	38	3.00	2020-1.99	■
2.00	4.00	6.00	38	3.00	2020-2.00	■

■ = disponible / verfügbar / available

Revêtement sur demande/Beschichtung auf Anfrage/Coating on request

Forets cylindriques
Zylindrische Bohrer
Cylindrical drills

Coupe à gauche
Linkschniden
Left hand cut

1010

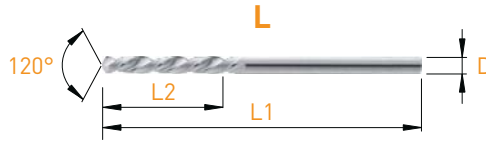

Z=2
MD
VHM
HM

D h6	L1	L2	Art. N°	Z
0.50	30	5	1010-0.50	■
0.55	30	5	1010-0.55	■
0.60	30	5	1010-0.60	■
0.65	30	6	1010-0.65	■
0.70	30	6	1010-0.70	■
0.75	30	8	1010-0.75	■
0.80	30	8	1010-0.80	■
0.85	30	9	1010-0.85	■
0.90	30	9	1010-0.90	■
0.95	30	10	1010-0.95	■
1.00	30	10	1010-1.00	■
1.05	30	10	1010-1.05	■
1.10	30	10	1010-1.10	■
1.15	30	12	1010-1.15	■
1.20	30	12	1010-1.20	■
1.25	30	12	1010-1.25	■
1.30	30	12	1010-1.30	■
1.35	30	12	1010-1.35	■
1.40	30	12	1010-1.40	■
1.45	30	12	1010-1.45	■
1.50	30	12	1010-1.50	■
1.55	40	16	1010-1.55	■
1.60	40	16	1010-1.60	■
1.65	40	16	1010-1.65	■
1.70	40	16	1010-1.70	■
1.75	40	16	1010-1.75	■
1.80	40	16	1010-1.80	■
1.85	40	16	1010-1.85	■
1.90	40	16	1010-1.90	■
1.95	40	16	1010-1.95	■
2.00	40	16	1010-2.00	■
2.05	40	18	1010-2.05	■
2.10	40	18	1010-2.10	■
2.15	40	18	1010-2.15	■
2.20	40	18	1010-2.20	■
2.25	40	18	1010-2.25	■
2.30	40	18	1010-2.30	■
2.35	40	18	1010-2.35	■
2.40	40	18	1010-2.40	■
2.45	40	18	1010-2.45	■
2.50	40	18	1010-2.50	■

D h6	L1	L2	Art. N°	Z
2.55	45	18	1010-2.55	■
2.60	45	18	1010-2.60	■
2.65	45	18	1010-2.65	■
2.70	45	18	1010-2.70	■
2.75	45	18	1010-2.75	■
2.80	45	18	1010-2.80	■
2.85	45	18	1010-2.85	■
2.90	45	18	1010-2.90	■
2.95	45	18	1010-2.95	■
3.00	45	18	1010-3.00	■
3.10	50	20	1010-3.10	■
3.20	50	20	1010-3.20	■
3.30	50	20	1010-3.30	■
3.40	50	20	1010-3.40	■
3.50	50	20	1010-3.50	■
3.60	50	20	1010-3.60	■
3.70	50	20	1010-3.70	■
3.80	50	20	1010-3.80	■
3.90	50	20	1010-3.90	■
4.00	50	20	1010-4.00	■
4.10	50	25	1010-4.10	■
4.20	50	25	1010-4.20	■
4.30	50	25	1010-4.30	■
4.40	50	25	1010-4.40	■
4.50	50	25	1010-4.50	■
4.60	50	25	1010-4.60	■
4.70	50	25	1010-4.70	■
4.80	50	25	1010-4.80	■
4.90	50	25	1010-4.90	■
5.00	50	25	1010-5.00	■
5.10	50	25	1010-5.10	■
5.20	50	25	1010-5.20	■
5.30	50	25	1010-5.30	■
5.40	50	25	1010-5.40	■
5.50	50	25	1010-5.50	■
5.60	50	25	1010-5.60	■
5.70	50	25	1010-5.70	■
5.80	50	25	1010-5.80	■
5.90	50	25	1010-5.90	■
6.00	50	25	1010-6.00	■

Forets cylindriques

Zylindrische Bohrer

Cylindrical drills

2010



120°

 λ 30°

Z=2

MD
VHM
HM

D h6	L1	L2	Art. N°	z
0.50	30	5	2010-0.50	■
0.55	30	5	2010-0.55	■
0.60	30	5	2010-0.60	■
0.65	30	6	2010-0.65	■
0.70	30	6	2010-0.70	■
0.75	30	8	2010-0.75	■
0.80	30	8	2010-0.80	■
0.85	30	9	2010-0.85	■
0.90	30	9	2010-0.90	■
0.95	30	10	2010-0.95	■
1.00	30	10	2010-1.00	■
1.05	30	10	2010-1.05	■
1.10	30	10	2010-1.10	■
1.15	30	12	2010-1.15	■
1.20	30	12	2010-1.20	■
1.25	30	12	2010-1.25	■
1.30	30	12	2010-1.30	■
1.35	30	12	2010-1.35	■
1.40	30	12	2010-1.40	■
1.45	30	12	2010-1.45	■
1.50	30	12	2010-1.50	■
1.55	40	16	2010-1.55	■
1.60	40	16	2010-1.60	■
1.65	40	16	2010-1.65	■
1.70	40	16	2010-1.70	■
1.75	40	16	2010-1.75	■
1.80	40	16	2010-1.80	■
1.85	40	16	2010-1.85	■
1.90	40	16	2010-1.90	■
1.95	40	16	2010-1.95	■
2.00	40	16	2010-2.00	■
2.05	40	18	2010-2.05	■
2.10	40	18	2010-2.10	■
2.15	40	18	2010-2.15	■
2.20	40	18	2010-2.20	■
2.25	40	18	2010-2.25	■
2.30	40	18	2010-2.30	■
2.35	40	18	2010-2.35	■
2.40	40	18	2010-2.40	■
2.45	40	18	2010-2.45	■
2.50	40	18	2010-2.50	■

D h6	L1	L2	Art. N°	z
2.55	45	18	2010-2.55	■
2.60	45	18	2010-2.60	■
2.65	45	18	2010-2.65	■
2.70	45	18	2010-2.70	■
2.75	45	18	2010-2.75	■
2.80	45	18	2010-2.80	■
2.85	45	18	2010-2.85	■
2.90	45	18	2010-2.90	■
2.95	45	18	2010-2.95	■
3.00	45	18	2010-3.00	■
3.10	50	20	2010-3.10	■
3.20	50	20	2010-3.20	■
3.30	50	20	2010-3.30	■
3.40	50	20	2010-3.40	■
3.50	50	20	2010-3.50	■
3.60	50	20	2010-3.60	■
3.70	50	20	2010-3.70	■
3.80	50	20	2010-3.80	■
3.90	50	20	2010-3.90	■
4.00	50	20	2010-4.00	■
4.10	50	25	2010-4.10	■
4.20	50	25	2010-4.20	■
4.30	50	25	2010-4.30	■
4.40	50	25	2010-4.40	■
4.50	50	25	2010-4.50	■
4.60	50	25	2010-4.60	■
4.70	50	25	2010-4.70	■
4.80	50	25	2010-4.80	■
4.90	50	25	2010-4.90	■
5.00	50	25	2010-5.00	■
5.10	50	25	2010-5.10	■
5.20	50	25	2010-5.20	■
5.30	50	25	2010-5.30	■
5.40	50	25	2010-5.40	■
5.50	50	25	2010-5.50	■
5.60	50	25	2010-5.60	■
5.70	50	25	2010-5.70	■
5.80	50	25	2010-5.80	■
5.90	50	25	2010-5.90	■
6.00	50	25	2010-6.00	■

■ = disponible / verfügbar / available

Revêtement sur demande / Beschichtung auf Anfrage / Coating on request



D1 h ₆	L2	D2 h ₆	L1	Art. N°	Z
0.80	2.00	2.00	30	2011-0.80	■
0.90	2.00	2.00	30	2011-0.90	■
1.00	2.00	2.00	30	2011-1.00	■
1.10	2.00	2.00	30	2011-1.10	■
1.20	2.50	2.00	30	2011-1.20	■
1.30	2.50	2.00	30	2011-1.30	■
1.40	2.50	2.00	30	2011-1.40	■
1.50	4.00	2.00	30	2011-1.50	■
2.00	5.00	2.00	30	2011-2.00	■

D1 h ₆	L2	D2 h ₆	L1	Art. N°	Z
0.50	1.70	1.50	30	2012-0.50	■
0.55	1.90	1.50	30	2012-0.55	■
0.60	1.90	1.50	30	2012-0.60	■
0.65	1.90	1.50	30	2012-0.65	■
0.70	2.40	1.50	30	2012-0.70	■
0.75	2.40	1.50	30	2012-0.75	■
0.80	2.60	1.50	30	2012-0.80	■
0.85	2.60	1.50	30	2012-0.85	■
0.90	3.00	1.50	30	2012-0.90	■
0.95	3.00	1.50	30	2012-0.95	■
1.00	3.40	1.50	30	2012-1.00	■
1.10	3.80	1.50	30	2012-1.10	■
1.20	4.20	1.50	30	2012-1.20	■
1.30	4.20	1.50	30	2012-1.30	■
1.40	4.70	1.50	30	2012-1.40	■
1.50	4.70	2.00	38	2012-1.50	■
1.60	5.40	2.00	38	2012-1.60	■
1.70	5.40	2.00	38	2012-1.70	■
1.80	6.50	2.00	38	2012-1.80	■
1.90	6.50	2.00	38	2012-1.90	■
2.00	6.50	3.00	38	2012-2.00	■
2.10	6.50	3.00	38	2012-2.10	■
2.20	6.50	3.00	38	2012-2.20	■
2.30	6.50	3.00	38	2012-2.30	■
2.40	6.50	3.00	38	2012-2.40	■

Micro-forets

Mikrobohrer

Micro drills

2013 / 2014

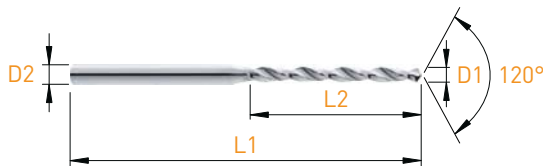
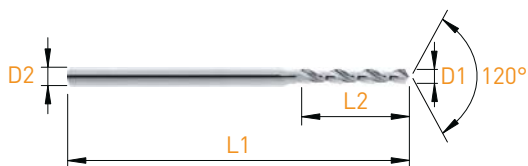

120°	λ^{35°		Z=2	MD VHM HM
------	----------------------	--	-----	-----------------

D1 _{h6}	L2	D2 _{h6}	L1	Art. N°	z
0.40	3.60	1.00	25	2013-0.40	■
0.45	3.60	1.00	25	2013-0.45	■
0.50	4.00	1.00	25	2013-0.50	■
0.55	4.50	1.00	25	2013-0.55	■
0.60	4.50	1.50	30	2013-0.60	■
0.65	5.00	1.50	30	2013-0.65	■
0.70	5.60	1.50	30	2013-0.70	■
0.75	5.60	1.50	30	2013-0.75	■
0.80	6.30	1.50	30	2013-0.80	■
0.85	6.30	1.50	30	2013-0.85	■
0.90	7.10	1.50	30	2013-0.90	■
0.95	7.10	1.50	30	2013-0.95	■
1.00	8.00	1.50	30	2013-1.00	■
1.05	8.00	1.50	30	2013-1.05	■
1.10	9.00	1.50	30	2013-1.10	■
1.15	9.00	1.50	30	2013-1.15	■
1.20	10.00	1.50	30	2013-1.20	■
1.25	10.00	1.50	30	2013-1.25	■
1.30	10.00	1.50	30	2013-1.30	■
1.35	11.20	1.50	30	2013-1.35	■
1.40	11.20	1.50	30	2013-1.40	■
1.45	11.20	1.50	30	2013-1.45	■
1.50	12.00	2.00	38	2013-1.50	■
1.60	12.00	2.00	38	2013-1.60	■
1.70	12.00	2.00	38	2013-1.70	■
1.80	12.00	2.00	38	2013-1.80	■
1.90	12.00	2.00	38	2013-1.90	■

120°	λ^{30°		Z=2	MD VHM HM
------	----------------------	--	-----	-----------------

D1 _{h6}	L2	D2 _{h6}	L1	Art. N°	z
0.50	6.00	1.50	30	2014-0.50	■
0.55	6.50	1.50	30	2014-0.55	■
0.60	6.50	1.50	30	2014-0.60	■
0.65	7.50	1.50	30	2014-0.65	■
0.70	8.50	1.50	30	2014-0.70	■
0.75	8.50	1.50	30	2014-0.75	■
0.80	9.50	1.50	30	2014-0.80	■
0.85	9.50	1.50	30	2014-0.85	■
0.90	10.50	1.50	30	2014-0.90	■
0.95	10.50	1.50	30	2014-0.95	■
1.00	12.00	1.50	38	2014-1.00	■
1.05	12.00	1.50	38	2014-1.05	■
1.10	13.50	1.50	38	2014-1.10	■
1.15	13.50	1.50	38	2014-1.15	■
1.20	15.00	1.50	38	2014-1.20	■
1.25	15.00	1.50	38	2014-1.25	■
1.30	17.00	1.50	38	2014-1.30	■
1.35	17.00	1.50	38	2014-1.35	■
1.40	17.00	1.50	38	2014-1.40	■
1.45	17.00	1.50	38	2014-1.45	■
1.50	18.00	2.00	38	2014-1.50	■
1.55	18.00	2.00	38	2014-1.55	■
1.60	18.00	2.00	38	2014-1.60	■
1.65	18.00	2.00	38	2014-1.65	■
1.70	18.00	2.00	38	2014-1.70	■
1.75	18.00	2.00	38	2014-1.75	■
1.80	18.00	2.00	38	2014-1.80	■
1.85	18.00	2.00	38	2014-1.85	■
1.90	18.00	2.00	38	2014-1.90	■
1.95	18.00	2.00	38	2014-1.95	■

MICRO-LINE

Micro-forets

Mikrobohrer

Micro drills

Ø 0.10 - Ø 0.99 mm

2023

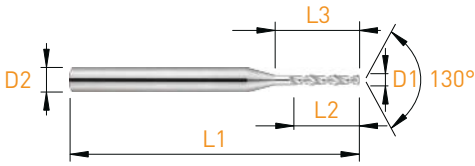

D1 0/-0.004	L2	L3	L1	D2 h6	Art. N°	z
0.10	0.50	0.70	38	3.00	2023-0.10	■
0.11	0.50	0.70	38	3.00	2023-0.11	■
0.12	0.50	0.70	38	3.00	2023-0.12	■
0.13	0.80	1.00	38	3.00	2023-0.13	■
0.14	0.80	1.00	38	3.00	2023-0.14	■
0.15	0.80	1.00	38	3.00	2023-0.15	■
0.16	1.10	1.40	38	3.00	2023-0.16	■
0.17	1.10	1.40	38	3.00	2023-0.17	■
0.18	1.10	1.40	38	3.00	2023-0.18	■
0.19	1.10	1.40	38	3.00	2023-0.19	■
0.20	1.50	1.80	38	3.00	2023-0.20	■
0.21	1.50	1.80	38	3.00	2023-0.21	■
0.22	1.50	1.80	38	3.00	2023-0.22	■
0.23	1.50	1.80	38	3.00	2023-0.23	■
0.24	1.50	1.80	38	3.00	2023-0.24	■
0.25	1.90	2.20	38	3.00	2023-0.25	■
0.26	1.90	2.20	38	3.00	2023-0.26	■
0.27	1.90	2.20	38	3.00	2023-0.27	■
0.28	1.90	2.20	38	3.00	2023-0.28	■
0.29	1.90	2.20	38	3.00	2023-0.29	■
0.30	1.80	2.40	38	3.00	2023-0.30	■
0.31	1.80	2.40	38	3.00	2023-0.31	■
0.32	1.80	2.40	38	3.00	2023-0.32	■
0.33	1.80	2.40	38	3.00	2023-0.33	■
0.34	1.80	2.40	38	3.00	2023-0.34	■
0.35	2.20	2.80	38	3.00	2023-0.35	■
0.36	2.20	2.80	38	3.00	2023-0.36	■
0.37	2.20	2.80	38	3.00	2023-0.37	■
0.38	2.20	2.80	38	3.00	2023-0.38	■
0.39	2.70	3.60	38	3.00	2023-0.39	■
0.40	2.70	3.60	38	3.00	2023-0.40	■
0.41	2.70	3.60	38	3.00	2023-0.41	■
0.42	2.70	3.60	38	3.00	2023-0.42	■
0.43	2.70	3.60	38	3.00	2023-0.43	■
0.44	2.70	3.60	38	3.00	2023-0.44	■
0.45	2.70	3.60	38	3.00	2023-0.45	■
0.46	2.70	3.60	38	3.00	2023-0.46	■
0.47	2.70	3.60	38	3.00	2023-0.47	■
0.48	2.70	3.60	38	3.00	2023-0.48	■

D1 0/-0.004	L2	L3	L1	D2 h6	Art. N°	z
0.49	3.20	4.00	38	3.00	2023-0.49	■
0.50	3.20	4.00	38	3.00	2023-0.50	■
0.51	3.20	4.00	38	3.00	2023-0.51	■
0.52	3.20	4.00	38	3.00	2023-0.52	■
0.53	3.20	4.00	38	3.00	2023-0.53	■
0.54	3.60	4.50	38	3.00	2023-0.54	■
0.55	3.60	4.50	38	3.00	2023-0.55	■
0.56	3.60	4.50	38	3.00	2023-0.56	■
0.57	3.60	4.50	38	3.00	2023-0.57	■
0.58	3.60	4.50	38	3.00	2023-0.58	■
0.59	3.60	4.50	38	3.00	2023-0.59	■
0.60	3.60	4.50	38	3.00	2023-0.60	■
0.61	3.90	5.00	38	3.00	2023-0.61	■
0.62	3.90	5.00	38	3.00	2023-0.62	■
0.63	3.90	5.00	38	3.00	2023-0.63	■
0.64	3.90	5.00	38	3.00	2023-0.64	■
0.65	3.90	5.00	38	3.00	2023-0.65	■
0.66	3.90	5.00	38	3.00	2023-0.66	■
0.67	3.90	5.00	38	3.00	2023-0.67	■
0.68	4.50	5.60	38	3.00	2023-0.68	■
0.69	4.50	5.60	38	3.00	2023-0.69	■
0.70	4.50	5.60	38	3.00	2023-0.70	■
0.71	4.50	5.60	38	3.00	2023-0.71	■
0.72	4.50	5.60	38	3.00	2023-0.72	■
0.73	4.50	5.60	38	3.00	2023-0.73	■
0.74	4.50	5.60	38	3.00	2023-0.74	■
0.75	4.50	5.60	38	3.00	2023-0.75	■
0.76	5.00	6.30	38	3.00	2023-0.76	■
0.77	5.00	6.30	38	3.00	2023-0.77	■
0.78	5.00	6.30	38	3.00	2023-0.78	■
0.79	5.00	6.30	38	3.00	2023-0.79	■
0.80	5.00	6.30	38	3.00	2023-0.80	■
0.81	5.00	6.30	38	3.00	2023-0.81	■
0.82	5.00	6.30	38	3.00	2023-0.82	■
0.83	5.00	6.30	38	3.00	2023-0.83	■
0.84	5.00	6.30	38	3.00	2023-0.84	■
0.85	5.00	6.30	38	3.00	2023-0.85	■
0.86	5.70	7.10	38	3.00	2023-0.86	■
0.87	5.70	7.10	38	3.00	2023-0.87	■
0.88	5.70	7.10	38	3.00	2023-0.88	■
0.89	5.70	7.10	38	3.00	2023-0.89	■
0.90	5.70	7.10	38	3.00	2023-0.90	■
0.91	5.70	7.10	38	3.00	2023-0.91	■
0.92	5.70	7.10	38	3.00	2023-0.92	■
0.93	5.70	7.10	38	3.00	2023-0.93	■
0.94	5.70	7.10	38	3.00	2023-0.94	■
0.95	5.70	7.10	38	3.00	2023-0.95	■
0.96	6.50	8.00	38	3.00	2023-0.96	■
0.97	6.50	8.00	38	3.00	2023-0.97	■
0.98	6.50	8.00	38	3.00	2023-0.98	■
0.99	6.50	8.00	38	3.00	2023-0.99	■

Micro-forets

Mikrobohrer

Micro drills

Ø 1.00 - Ø 2.00 mm

2023

D1 0/-0.004	L2	L3	L1	D2 h6	Art. N°	Z
1.00	6.50	8.00	38	3.00	2023-1.00	■
1.01	6.50	8.00	38	3.00	2023-1.01	■
1.02	6.50	8.00	38	3.00	2023-1.02	■
1.03	6.50	8.00	38	3.00	2023-1.03	■
1.04	6.50	8.00	38	3.00	2023-1.04	■
1.05	6.50	8.00	38	3.00	2023-1.05	■
1.06	7.30	9.00	38	3.00	2023-1.06	■
1.07	7.30	9.00	38	3.00	2023-1.07	■
1.08	7.30	9.00	38	3.00	2023-1.08	■
1.09	7.30	9.00	38	3.00	2023-1.09	■
1.10	7.30	9.00	38	3.00	2023-1.10	■
1.11	7.30	9.00	38	3.00	2023-1.11	■
1.12	7.30	9.00	38	3.00	2023-1.12	■
1.13	7.30	9.00	38	3.00	2023-1.13	■
1.14	7.30	9.00	38	3.00	2023-1.14	■
1.15	7.30	9.00	38	3.00	2023-1.15	■
1.16	8.20	10.00	38	3.00	2023-1.16	■
1.17	8.20	10.00	38	3.00	2023-1.17	■
1.18	8.20	10.00	38	3.00	2023-1.18	■
1.19	8.20	10.00	38	3.00	2023-1.19	■
1.20	8.20	10.00	38	3.00	2023-1.20	■
1.21	8.20	10.00	38	3.00	2023-1.21	■
1.22	8.20	10.00	38	3.00	2023-1.22	■
1.23	8.20	10.00	38	3.00	2023-1.23	■
1.24	8.20	10.00	38	3.00	2023-1.24	■
1.25	8.20	10.00	38	3.00	2023-1.25	■
1.26	8.20	10.00	38	3.00	2023-1.26	■
1.27	8.20	10.00	38	3.00	2023-1.27	■
1.28	8.20	10.00	38	3.00	2023-1.28	■
1.29	8.20	10.00	38	3.00	2023-1.29	■
1.30	8.20	10.00	38	3.00	2023-1.30	■
1.31	9.20	11.20	38	3.00	2023-1.31	■
1.32	9.20	11.20	38	3.00	2023-1.32	■
1.33	9.20	11.20	38	3.00	2023-1.33	■
1.34	9.20	11.20	38	3.00	2023-1.34	■
1.35	9.20	11.20	38	3.00	2023-1.35	■
1.36	9.20	11.20	38	3.00	2023-1.36	■
1.37	9.20	11.20	38	3.00	2023-1.37	■
1.38	9.20	11.20	38	3.00	2023-1.38	■
1.39	9.20	11.20	38	3.00	2023-1.39	■
1.40	9.20	11.20	38	3.00	2023-1.40	■
1.41	9.20	11.20	38	3.00	2023-1.41	■
1.42	9.20	11.20	38	3.00	2023-1.42	■
1.43	9.20	11.20	38	3.00	2023-1.43	■
1.44	9.20	11.20	38	3.00	2023-1.44	■
1.45	9.20	11.20	38	3.00	2023-1.45	■
1.46	9.20	11.20	38	3.00	2023-1.46	■
1.47	9.20	11.20	38	3.00	2023-1.47	■
1.48	9.20	11.20	38	3.00	2023-1.48	■
1.49	9.20	11.20	38	3.00	2023-1.49	■
1.50	9.20	11.20	38	3.00	2023-1.50	■

D1 0/-0.004	L2	L3	L1	D2 h6	Art. N°	Z
1.51	11.20	13.40	38	3.00	2023-1.51	■
1.52	11.20	13.40	38	3.00	2023-1.52	■
1.53	11.20	13.40	38	3.00	2023-1.53	■
1.54	11.20	13.40	38	3.00	2023-1.54	■
1.55	11.20	13.40	38	3.00	2023-1.55	■
1.56	11.20	13.40	38	3.00	2023-1.56	■
1.57	11.20	13.40	38	3.00	2023-1.57	■
1.58	11.20	13.40	38	3.00	2023-1.58	■
1.59	11.20	13.40	38	3.00	2023-1.59	■
1.60	11.20	13.40	38	3.00	2023-1.60	■
1.61	11.20	13.40	38	3.00	2023-1.61	■
1.62	11.20	13.40	38	3.00	2023-1.62	■
1.63	11.20	13.40	38	3.00	2023-1.63	■
1.64	11.20	13.40	38	3.00	2023-1.64	■
1.65	11.20	13.40	38	3.00	2023-1.65	■
1.66	11.20	13.40	38	3.00	2023-1.66	■
1.67	11.20	13.40	38	3.00	2023-1.67	■
1.68	11.20	13.40	38	3.00	2023-1.68	■
1.69	11.20	13.40	38	3.00	2023-1.69	■
1.70	11.20	13.40	38	3.00	2023-1.70	■
1.71	11.20	13.40	38	3.00	2023-1.71	■
1.72	11.20	13.40	38	3.00	2023-1.72	■
1.73	11.20	13.40	38	3.00	2023-1.73	■
1.74	11.20	13.40	38	3.00	2023-1.74	■
1.75	11.20	13.40	38	3.00	2023-1.75	■
1.76	11.20	13.40	38	3.00	2023-1.76	■
1.77	11.20	13.40	38	3.00	2023-1.77	■
1.78	11.20	13.40	38	3.00	2023-1.78	■
1.79	11.20	13.40	38	3.00	2023-1.79	■
1.80	11.20	13.40	38	3.00	2023-1.80	■
1.81	11.20	13.40	38	3.00	2023-1.81	■
1.82	11.20	13.40	38	3.00	2023-1.82	■
1.83	11.20	13.40	38	3.00	2023-1.83	■
1.84	11.20	13.40	38	3.00	2023-1.84	■
1.85	11.20	13.40	38	3.00	2023-1.85	■
1.86	11.20	13.40	38	3.00	2023-1.86	■
1.87	11.20	13.40	38	3.00	2023-1.87	■
1.88	11.20	13.40	38	3.00	2023-1.88	■
1.89	11.20	13.40	38	3.00	2023-1.89	■
1.90	11.20	13.40	38	3.00	2023-1.90	■
1.91	11.20	13.40	38	3.00	2023-1.91	■
1.92	11.20	13.40	38	3.00	2023-1.92	■
1.93	11.20	13.40	38	3.00	2023-1.93	■
1.94	11.20	13.40	38	3.00	2023-1.94	■
1.95	11.20	13.40	38	3.00	2023-1.95	■
1.96	11.20	13.40	38	3.00	2023-1.96	■
1.97	11.20	13.40	38	3.00	2023-1.97	■
1.98	11.20	13.40	38	3.00	2023-1.98	■
1.99	11.20	13.40	38	3.00	2023-1.99	■
2.00	11.20	13.40	38	3.00	2023-2.00	■

D1 0/-0.004	L2	L3	L1	D2 h6	Art. N°	Z
2.01	12.50	14.00	38	3.00	2023-2.01	■
2.02	12.50	14.00	38	3.00	2023-2.02	■
2.03	12.50	14.00	38	3.00	2023-2.03	■
2.04	12.50	14.00	38	3.00	2023-2.04	■
2.05	12.50	14.00	38	3.00	2023-2.05	■
2.06	12.50	14.00	38	3.00	2023-2.06	■
2.07	12.50	14.00	38	3.00	2023-2.07	■
2.08	12.50	14.00	38	3.00	2023-2.08	■
2.09	12.50	14.00	38	3.00	2023-2.09	■
2.10	12.50	14.00	38	3.00	2023-2.10	■
2.11	12.50	14.00	38	3.00	2023-2.11	■
2.12	12.50	14.00	38	3.00	2023-2.12	■
2.13	12.50	14.00	38	3.00	2023-2.13	■
2.14	12.50	14.00	38	3.00	2023-2.14	■
2.15	12.50	14.00	38	3.00	2023-2.15	■
2.16	12.50	14.00	38	3.00	2023-2.16	■
2.17	12.50	14.00	38	3.00	2023-2.17	■
2.18	12.50	14.00	38	3.00	2023-2.18	■
2.19	12.50	14.00	38	3.00	2023-2.19	■
2.20	12.50	14.00	38	3.00	2023-2.20	■
2.21	12.50	14.00	38	3.00	2023-2.21	■
2.22	12.50	14.00	38	3.00	2023-2.22	■
2.23	12.50	14.00	38	3.00	2023-2.23	■
2.24	12.50	14.00	38	3.00	2023-2.24	■
2.25	12.50	14.00	38	3.00	2023-2.25	■
2.26	12.50	14.00	38	3.00	2023-2.26	■
2.27	12.50	14.00	38	3.00	2023-2.27	■
2.28	12.50	14.00	38	3.00	2023-2.28	■
2.29	12.50	14.00	38	3.00	2023-2.29	■
2.30	12.50	14.00	38	3.00	2023-2.30	■
2.31	12.50	14.00	38	3.00	2023-2.31	■
2.32	12.50	14.00	38	3.00	2023-2.32	■
2.33	12.50	14.00	38	3.00	2023-2.33	■
2.34	12.50	14.00	38	3.00	2023-2.34	■
2.35	12.50	14.00	38	3.00	2023-2.35	■
2.36	12.50	14.00	38	3.00	2023-2.36	■
2.37	12.50	14.00	38	3.00	2023-2.37	■
2.38	12.50	14.00	38	3.00	2023-2.38	■
2.39	12.50	14.00	38	3.00	2023-2.39	■
2.40	12.50	14.00	38	3.00	2023-2.40	■
2.41	12.50	14.00	38	3.00	2023-2.41	■
2.42	12.50	14.00	38	3.00	2023-2.42	■
2.43	12.50	14.00	38	3.00	2023-2.43	■
2.44	12.50	14.00	38	3.00	2023-2.44	■
2.45	12.50	14.00	38	3.00	2023-2.45	■
2.46	12.50	14.00	38	3.00	2023-2.46	■
2.47	12.50	14.00	38	3.00	2023-2.47	■
2.48	12.50	14.00	38	3.00	2023-2.48	■
2.49	12.50	14.00	38	3.00	2023-2.49	■
2.50	14.00	17.00	38	3.00	2023-2.50	■

D1 0/-0.004	L2	L3	L1	D2 h6	Art. N°	Z
2.51	14.00	17.00	38	3.00	2023-2.51	■
2.52	14.00	17.00	38	3.00	2023-2.52	■
2.53	14.00	17.00	38	3.00	2023-2.53	■
2.54	14.00	17.00	38	3.00	2023-2.54	■
2.55	14.00	17.00	38	3.00	2023-2.55	■
2.56	14.00	17.00	38	3.00	2023-2.56	■
2.57	14.00	17.00	38	3.00	2023-2.57	■
2.58	14.00	17.00	38	3.00	2023-2.58	■
2.59	14.00	17.00	38	3.00	2023-2.59	■
2.60	14.00	17.00	38	3.00	2023-2.60	■
2.61	14.00	17.00	38	3.00	2023-2.61	■
2.62	14.00	17.00	38	3.00	2023-2.62	■
2.63	14.00	17.00	38	3.00	2023-2.63	■
2.64	14.00	17.00	38	3.00	2023-2.64	■
2.65	14.00	17.00	38	3.00	2023-2.65	■
2.66	14.00	17.00	38	3.00	2023-2.66	■
2.67	14.00	17.00	38	3.00	2023-2.67	■
2.68	14.00	17.00	38	3.00	2023-2.68	■
2.69	14.00	17.00	38	3.00	2023-2.69	■
2.70	14.00	17.00	38	3.00	2023-2.70	■
2.71	14.00	17.00	38	3.00	2023-2.71	■
2.72	14.00	17.00	38	3.00	2023-2.72	■
2.73	14.00	17.00	38	3.00	2023-2.73	■
2.74	14.00	17.00	38	3.00	2023-2.74	■
2.75	14.00	17.00	38	3.00	2023-2.75	■
2.76	14.00	17.00	38	3.00	2023-2.76	■
2.77	14.00	17.00	38	3.00	2023-2.77	■
2.78	14.00	17.00	38	3.00	2023-2.78	■
2.79	14.00	17.00	38	3.00	2023-2.79	■
2.80	14.00	17.00	38	3.00	2023-2.80	■
2.81	14.00	17.00	38	3.00	2023-2.81	■
2.82	14.00	17.00	38	3.00	2023-2.82	■
2.83	14.00	17.00	38	3.00	2023-2.83	■
2.84	14.00	17.00	38	3.00	2023-2.84	■
2.85	14.00	17.00	38	3.00	2023-2.85	■
2.86	14.00	17.00	38	3.00	2023-2.86	■
2.87	14.00	17.00	38	3.00	2023-2.87	■
2.88	14.00	17.00	38	3.00	2023-2.88	■
2.89	14.00	17.00	38	3.00	2023-2.89	■
2.90	14.00	17.00	38	3.00	2023-2.90	■
2.91	14.00	17.00	38	3.00	2023-2.91	■
2.92	14.00	17.00	38	3.00	2023-2.92	■
2.93	14.00	17.00	38	3.00	2023-2.93	■
2.94	14.00	17.00	38	3.00	2023-2.94	■
2.95	14.00	17.00	38	3.00	2023-2.95	■
2.96	14.00	17.00	38	3.00	2023-2.96	■
2.97	14.00	17.00	38	3.00	2023-2.97	■
2.98	14.00	17.00	38	3.00	2023-2.98	■
2.99	14.00	17.00	38	3.00	2023-2.99	■
3.00	14.00	17.00	38	3.00	2023-3.00	■

Micro-forets

Mikrobohrer

Micro drills

Ø 0.20 - Ø 1.09 mm

2026

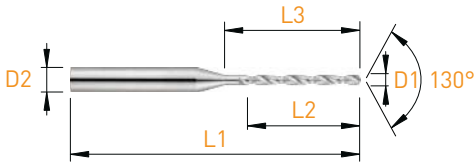

130°

λ 25°



Z=2

12xD1

MD
VHM
HM

D1 h6	L2	L3	L1	D2 h6	Art. N°	z
0.20	2.40	3.50	38	3.00	2026-0.20	■
0.21	2.50	3.50	38	3.00	2026-0.21	■
0.22	2.70	3.50	38	3.00	2026-0.22	■
0.23	2.80	3.50	38	3.00	2026-0.23	■
0.24	2.90	4.00	38	3.00	2026-0.24	■
0.25	3.00	4.00	38	3.00	2026-0.25	■
0.26	3.10	4.00	38	3.00	2026-0.26	■
0.27	3.30	4.00	38	3.00	2026-0.27	■
0.28	3.40	4.50	38	3.00	2026-0.28	■
0.29	3.50	4.50	38	3.00	2026-0.29	■
0.30	3.60	4.50	38	3.00	2026-0.30	■
0.31	3.70	4.50	38	3.00	2026-0.31	■
0.32	3.90	5.00	38	3.00	2026-0.32	■
0.33	4.00	5.00	38	3.00	2026-0.33	■
0.34	4.10	5.00	38	3.00	2026-0.34	■
0.35	4.20	5.00	38	3.00	2026-0.35	■
0.36	4.30	5.50	38	3.00	2026-0.36	■
0.37	4.50	5.50	38	3.00	2026-0.37	■
0.38	4.60	5.50	38	3.00	2026-0.38	■
0.39	4.70	5.50	38	3.00	2026-0.39	■
0.40	4.80	6.00	38	3.00	2026-0.40	■
0.41	4.90	6.00	38	3.00	2026-0.41	■
0.42	5.10	6.00	38	3.00	2026-0.42	■
0.43	5.20	6.00	38	3.00	2026-0.43	■
0.44	5.30	6.50	38	3.00	2026-0.44	■
0.45	5.40	6.50	38	3.00	2026-0.45	■
0.46	5.50	6.50	38	3.00	2026-0.46	■
0.47	5.70	6.50	38	3.00	2026-0.47	■
0.48	5.80	7.00	38	3.00	2026-0.48	■
0.49	5.90	7.00	38	3.00	2026-0.49	■
0.50	6.00	7.00	38	3.00	2026-0.50	■
0.51	6.10	7.00	38	3.00	2026-0.51	■
0.52	6.30	7.50	38	3.00	2026-0.52	■
0.53	6.40	7.50	38	3.00	2026-0.53	■
0.54	6.50	7.50	38	3.00	2026-0.54	■
0.55	6.60	7.50	38	3.00	2026-0.55	■
0.56	6.70	8.00	38	3.00	2026-0.56	■
0.57	6.90	8.00	38	3.00	2026-0.57	■
0.58	7.00	8.00	38	3.00	2026-0.58	■

D1 h6	L2	L3	L1	D2 h6	Art. N°	z
0.59	7.10	8.00	38	3.00	2026-0.59	■
0.60	7.20	9.00	38	3.00	2026-0.60	■
0.61	7.30	9.00	38	3.00	2026-0.61	■
0.62	7.50	9.00	38	3.00	2026-0.62	■
0.63	7.60	9.00	38	3.00	2026-0.63	■
0.64	7.70	9.50	38	3.00	2026-0.64	■
0.65	7.80	9.50	38	3.00	2026-0.65	■
0.66	7.90	9.50	38	3.00	2026-0.66	■
0.67	8.10	9.50	38	3.00	2026-0.67	■
0.68	8.20	10.00	38	3.00	2026-0.68	■
0.69	8.30	10.00	38	3.00	2026-0.69	■
0.70	8.40	10.00	38	3.00	2026-0.70	■
0.71	8.50	10.00	38	3.00	2026-0.71	■
0.72	8.70	10.50	38	3.00	2026-0.72	■
0.73	8.80	10.50	38	3.00	2026-0.73	■
0.74	8.90	10.50	38	3.00	2026-0.74	■
0.75	9.00	10.50	38	3.00	2026-0.75	■
0.76	9.10	11.00	38	3.00	2026-0.76	■
0.77	9.30	11.00	38	3.00	2026-0.77	■
0.78	9.40	11.00	38	3.00	2026-0.78	■
0.79	9.50	11.00	38	3.00	2026-0.79	■
0.80	9.60	11.50	38	3.00	2026-0.80	■
0.81	9.70	11.50	38	3.00	2026-0.81	■
0.82	9.90	11.50	38	3.00	2026-0.82	■
0.83	10.00	11.50	38	3.00	2026-0.83	■
0.84	10.10	12.00	38	3.00	2026-0.84	■
0.85	10.20	12.00	38	3.00	2026-0.85	■
0.86	10.30	12.00	38	3.00	2026-0.86	■
0.87	10.50	12.00	38	3.00	2026-0.87	■
0.88	10.60	12.50	38	3.00	2026-0.88	■
0.89	10.70	12.50	38	3.00	2026-0.89	■
0.90	10.80	12.50	38	3.00	2026-0.90	■
0.91	10.90	12.50	38	3.00	2026-0.91	■
0.92	11.10	13.00	38	3.00	2026-0.92	■
0.93	11.20	13.00	38	3.00	2026-0.93	■
0.94	11.30	13.00	38	3.00	2026-0.94	■
0.95	11.40	13.00	38	3.00	2026-0.95	■
0.96	11.50	13.50	38	3.00	2026-0.96	■
0.97	11.70	13.50	38	3.00	2026-0.97	■
0.98	11.80	13.50	38	3.00	2026-0.98	■
0.99	11.90	13.50	38	3.00	2026-0.99	■
1.00	12.00	14.50	38	3.00	2026-1.00	■
1.01	12.10	14.50	38	3.00	2026-1.01	■
1.02	12.30	14.50	38	3.00	2026-1.02	■
1.03	12.40	14.50	38	3.00	2026-1.03	■
1.04	12.50	15.00	38	3.00	2026-1.04	■
1.05	12.60	15.00	38	3.00	2026-1.05	■
1.06	12.70	15.00	38	3.00	2026-1.06	■
1.07	12.90	15.00	38	3.00	2026-1.07	■
1.08	13.00	15.50	38	3.00	2026-1.08	■
1.09	13.10	15.50	38	3.00	2026-1.09	■

D1 h6	L2	L3	L1	D2 h6	Art. N°	Z
1.10	13.20	15.50	38	3.00	2026-1.10	■
1.11	13.30	15.50	38	3.00	2026-1.11	■
1.12	13.50	16.00	38	3.00	2026-1.12	■
1.13	13.60	16.00	38	3.00	2026-1.13	■
1.14	13.70	16.00	38	3.00	2026-1.14	■
1.15	13.80	16.00	38	3.00	2026-1.15	■
1.16	13.90	16.50	38	3.00	2026-1.16	■
1.17	14.10	16.50	38	3.00	2026-1.17	■
1.18	14.20	16.50	38	3.00	2026-1.18	■
1.19	14.30	16.50	38	3.00	2026-1.19	■
1.20	14.40	17.00	38	3.00	2026-1.20	■
1.21	14.50	17.00	38	3.00	2026-1.21	■
1.22	14.70	17.00	38	3.00	2026-1.22	■
1.23	14.80	17.00	38	3.00	2026-1.23	■
1.24	14.90	17.50	38	3.00	2026-1.24	■
1.25	15.00	17.50	38	3.00	2026-1.25	■
1.26	15.10	17.50	50	3.00	2026-1.26	■
1.27	15.30	17.50	50	3.00	2026-1.27	■
1.28	15.40	18.00	50	3.00	2026-1.28	■
1.29	15.50	18.00	50	3.00	2026-1.29	■
1.30	15.60	18.00	50	3.00	2026-1.30	■
1.31	15.70	18.00	50	3.00	2026-1.31	■
1.32	15.90	18.50	50	3.00	2026-1.32	■
1.33	16.00	18.50	50	3.00	2026-1.33	■
1.34	16.10	18.50	50	3.00	2026-1.34	■
1.35	16.20	18.50	50	3.00	2026-1.35	■
1.36	16.30	19.00	50	3.00	2026-1.36	■
1.37	16.50	19.00	50	3.00	2026-1.37	■
1.38	16.60	19.00	50	3.00	2026-1.38	■
1.39	16.70	19.00	50	3.00	2026-1.39	■
1.40	16.80	19.50	50	3.00	2026-1.40	■
1.41	16.90	19.50	50	3.00	2026-1.41	■
1.42	17.10	19.50	50	3.00	2026-1.42	■
1.43	17.20	19.50	50	3.00	2026-1.43	■
1.44	17.30	20.00	50	3.00	2026-1.44	■
1.45	17.40	20.00	50	3.00	2026-1.45	■
1.46	17.50	20.00	50	3.00	2026-1.46	■
1.47	17.70	20.00	50	3.00	2026-1.47	■
1.48	17.80	20.50	50	3.00	2026-1.48	■
1.49	17.90	20.50	50	3.00	2026-1.49	■
1.50	18.00	21.00	50	3.00	2026-1.50	■
1.51	18.10	21.00	50	3.00	2026-1.51	■
1.52	18.30	21.00	50	3.00	2026-1.52	■
1.53	18.40	21.00	50	3.00	2026-1.53	■
1.54	18.50	21.50	50	3.00	2026-1.54	■
1.55	18.60	21.50	50	3.00	2026-1.55	■
1.56	18.70	21.50	50	3.00	2026-1.56	■
1.57	18.90	21.50	50	3.00	2026-1.57	■
1.58	19.00	22.00	50	3.00	2026-1.58	■
1.59	19.10	22.00	50	3.00	2026-1.59	■
1.60	19.20	22.00	50	3.00	2026-1.60	■

D1 h6	L2	L3	L1	D2 h6	Art. N°	Z
1.61	19.30	22.00	50	3.00	2026-1.61	■
1.62	19.40	22.50	50	3.00	2026-1.62	■
1.63	19.60	22.50	50	3.00	2026-1.63	■
1.64	19.70	22.50	50	3.00	2026-1.64	■
1.65	19.80	22.50	50	3.00	2026-1.65	■
1.66	19.90	23.00	50	3.00	2026-1.66	■
1.67	20.10	23.00	50	3.00	2026-1.67	■
1.68	20.20	23.00	50	3.00	2026-1.68	■
1.69	20.30	23.00	50	3.00	2026-1.69	■
1.70	20.40	23.50	50	3.00	2026-1.70	■
1.71	20.50	23.50	50	3.00	2026-1.71	■
1.72	20.70	23.50	50	3.00	2026-1.72	■
1.73	20.80	23.50	50	3.00	2026-1.73	■
1.74	20.90	24.00	50	3.00	2026-1.74	■
1.75	21.00	24.00	50	3.00	2026-1.75	■
1.76	21.10	24.00	50	3.00	2026-1.76	■
1.77	21.30	24.00	50	3.00	2026-1.77	■
1.78	21.40	24.50	50	3.00	2026-1.78	■
1.79	21.50	24.50	50	3.00	2026-1.79	■
1.80	21.60	25.00	50	3.00	2026-1.80	■
1.81	21.70	25.00	50	3.00	2026-1.81	■
1.82	21.90	25.00	50	3.00	2026-1.82	■
1.83	22.00	25.00	50	3.00	2026-1.83	■
1.84	22.10	25.50	50	3.00	2026-1.84	■
1.85	22.20	25.50	50	3.00	2026-1.85	■
1.86	22.30	25.50	50	3.00	2026-1.86	■
1.87	22.50	25.50	50	3.00	2026-1.87	■
1.88	22.60	26.00	50	3.00	2026-1.88	■
1.89	22.70	26.00	50	3.00	2026-1.89	■
1.90	22.80	26.00	50	3.00	2026-1.90	■
1.91	22.90	26.00	50	3.00	2026-1.91	■
1.92	23.10	26.50	50	3.00	2026-1.92	■
1.93	23.20	26.50	50	3.00	2026-1.93	■
1.94	23.30	26.50	50	3.00	2026-1.94	■
1.95	23.40	26.50	50	3.00	2026-1.95	■
1.96	23.50	27.00	50	3.00	2026-1.96	■
1.97	23.70	27.00	50	3.00	2026-1.97	■
1.98	23.80	27.00	50	3.00	2026-1.98	■
1.99	23.90	27.00	50	3.00	2026-1.99	■
2.00	24.00	27.00	50	3.00	2026-2.00	■

Micro-forets

Mikrobohrer

Micro drills

Ø 0.20 - Ø 1.09 mm

2030

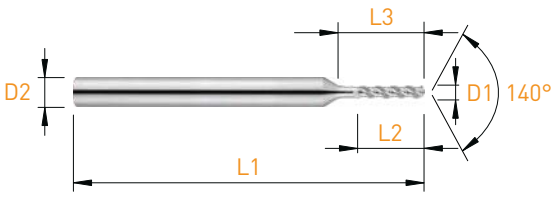

140°

λ 35°



Z=3

5xD1

MD

VHM

HM

D1 h6	L2	L3	L1	D2 h6	Art. N°	z
0.20	1.00	1.50	38	3.00	2030-0.20	■
0.21	1.05	1.50	38	3.00	2030-0.21	■
0.22	1.10	1.60	38	3.00	2030-0.22	■
0.23	1.15	1.60	38	3.00	2030-0.23	■
0.24	1.20	1.70	38	3.00	2030-0.24	■
0.25	1.25	1.70	38	3.00	2030-0.25	■
0.26	1.30	1.80	38	3.00	2030-0.26	■
0.27	1.35	1.80	38	3.00	2030-0.27	■
0.28	1.40	1.90	38	3.00	2030-0.28	■
0.29	1.45	1.90	38	3.00	2030-0.29	■
0.30	1.50	2.00	38	3.00	2030-0.30	■
0.31	1.55	2.00	38	3.00	2030-0.31	■
0.32	1.60	2.10	38	3.00	2030-0.32	■
0.33	1.65	2.10	38	3.00	2030-0.33	■
0.34	1.70	2.20	38	3.00	2030-0.34	■
0.35	1.75	2.20	38	3.00	2030-0.35	■
0.36	1.80	2.30	38	3.00	2030-0.36	■
0.37	1.85	2.30	38	3.00	2030-0.37	■
0.38	1.90	2.40	38	3.00	2030-0.38	■
0.39	1.95	2.40	38	3.00	2030-0.39	■
0.40	2.00	2.50	38	3.00	2030-0.40	■
0.41	2.05	2.50	38	3.00	2030-0.41	■
0.42	2.10	2.60	38	3.00	2030-0.42	■
0.43	2.15	2.60	38	3.00	2030-0.43	■
0.44	2.20	2.70	38	3.00	2030-0.44	■
0.45	2.25	2.70	38	3.00	2030-0.45	■
0.46	2.30	2.80	38	3.00	2030-0.46	■
0.47	2.35	2.80	38	3.00	2030-0.47	■
0.48	2.40	2.90	38	3.00	2030-0.48	■
0.49	2.45	2.90	38	3.00	2030-0.49	■
0.50	2.50	3.00	38	3.00	2030-0.50	■
0.51	2.55	3.00	38	3.00	2030-0.51	■
0.52	2.60	3.10	38	3.00	2030-0.52	■
0.53	2.65	3.10	38	3.00	2030-0.53	■
0.54	2.70	3.20	38	3.00	2030-0.54	■
0.55	2.75	3.20	38	3.00	2030-0.55	■
0.56	2.80	3.30	38	3.00	2030-0.56	■
0.57	2.85	3.30	38	3.00	2030-0.57	■
0.58	2.90	3.40	38	3.00	2030-0.58	■

D1 h6	L2	L3	L1	D2 h6	Art. N°	z
0.59	2.95	3.40	38	3.00	2030-0.59	■
0.60	3.00	3.50	38	3.00	2030-0.60	■
0.61	3.05	3.50	38	3.00	2030-0.61	■
0.62	3.10	3.60	38	3.00	2030-0.62	■
0.63	3.15	3.60	38	3.00	2030-0.63	■
0.64	3.20	3.70	38	3.00	2030-0.64	■
0.65	3.25	3.70	38	3.00	2030-0.65	■
0.66	3.30	3.80	38	3.00	2030-0.66	■
0.67	3.35	3.80	38	3.00	2030-0.67	■
0.68	3.40	3.90	38	3.00	2030-0.68	■
0.69	3.45	3.90	38	3.00	2030-0.69	■
0.70	3.50	4.00	38	3.00	2030-0.70	■
0.71	3.55	4.00	38	3.00	2030-0.71	■
0.72	3.60	4.10	38	3.00	2030-0.72	■
0.73	3.65	4.10	38	3.00	2030-0.73	■
0.74	3.70	4.20	38	3.00	2030-0.74	■
0.75	3.75	4.20	38	3.00	2030-0.75	■
0.76	3.80	4.30	38	3.00	2030-0.76	■
0.77	3.85	4.30	38	3.00	2030-0.77	■
0.78	3.90	4.40	38	3.00	2030-0.78	■
0.79	3.95	4.40	38	3.00	2030-0.79	■
0.80	4.00	4.50	38	3.00	2030-0.80	■
0.81	4.05	4.50	38	3.00	2030-0.81	■
0.82	4.10	4.60	38	3.00	2030-0.82	■
0.83	4.15	4.60	38	3.00	2030-0.83	■
0.84	4.20	4.70	38	3.00	2030-0.84	■
0.85	4.25	4.70	38	3.00	2030-0.85	■
0.86	4.30	4.80	38	3.00	2030-0.86	■
0.87	4.35	4.80	38	3.00	2030-0.87	■
0.88	4.40	4.90	38	3.00	2030-0.88	■
0.89	4.45	4.90	38	3.00	2030-0.89	■
0.90	4.50	5.00	38	3.00	2030-0.90	■
0.91	4.55	5.00	38	3.00	2030-0.91	■
0.92	4.60	5.10	38	3.00	2030-0.92	■
0.93	4.65	5.10	38	3.00	2030-0.93	■
0.94	4.70	5.20	38	3.00	2030-0.94	■
0.95	4.75	5.20	38	3.00	2030-0.95	■
0.96	4.80	5.30	38	3.00	2030-0.96	■
0.97	4.85	5.30	38	3.00	2030-0.97	■
0.98	4.90	5.40	38	3.00	2030-0.98	■
0.99	4.95	5.40	38	3.00	2030-0.99	■
1.00	5.00	6.50	38	3.00	2030-1.00	■
1.01	5.05	6.50	38	3.00	2030-1.01	■
1.02	5.10	6.50	38	3.00	2030-1.02	■
1.03	5.15	6.50	38	3.00	2030-1.03	■
1.04	5.20	6.50	38	3.00	2030-1.04	■
1.05	5.25	6.50	38	3.00	2030-1.05	■
1.06	5.30	6.50	38	3.00	2030-1.06	■
1.07	5.35	7.50	38	3.00	2030-1.07	■
1.08	5.40	7.50	38	3.00	2030-1.08	■
1.09	5.45	7.50	38	3.00	2030-1.09	■

D1 h6	L2	L3	L1	D2 h6	Art. N°	Z
1.10	5.50	7.50	38	3.00	2030-1.10	■
1.11	5.55	7.50	38	3.00	2030-1.11	■
1.12	5.60	7.50	38	3.00	2030-1.12	■
1.13	5.65	7.50	38	3.00	2030-1.13	■
1.14	5.70	7.50	38	3.00	2030-1.14	■
1.15	5.75	7.50	38	3.00	2030-1.15	■
1.16	5.80	7.50	38	3.00	2030-1.16	■
1.17	5.85	7.50	38	3.00	2030-1.17	■
1.18	5.90	8.50	38	3.00	2030-1.18	■
1.19	5.95	8.50	38	3.00	2030-1.19	■
1.20	6.00	8.50	38	3.00	2030-1.20	■
1.21	6.05	8.50	38	3.00	2030-1.21	■
1.22	6.10	8.50	38	3.00	2030-1.22	■
1.23	6.15	8.50	38	3.00	2030-1.23	■
1.24	6.20	8.50	38	3.00	2030-1.24	■
1.25	6.25	8.50	38	3.00	2030-1.25	■
1.26	6.30	8.50	38	3.00	2030-1.26	■
1.27	6.35	8.50	38	3.00	2030-1.27	■
1.28	6.40	8.50	38	3.00	2030-1.28	■
1.29	6.45	8.50	38	3.00	2030-1.29	■
1.30	6.50	8.50	38	3.00	2030-1.30	■
1.31	6.55	8.50	38	3.00	2030-1.31	■
1.32	6.60	8.50	38	3.00	2030-1.32	■
1.33	6.65	9.50	38	3.00	2030-1.33	■
1.34	6.70	9.50	38	3.00	2030-1.34	■
1.35	6.75	9.50	38	3.00	2030-1.35	■
1.36	6.80	9.50	38	3.00	2030-1.36	■
1.37	6.85	9.50	38	3.00	2030-1.37	■
1.38	6.90	9.50	38	3.00	2030-1.38	■
1.39	6.95	9.50	38	3.00	2030-1.39	■
1.40	7.00	9.50	38	3.00	2030-1.40	■
1.41	7.05	9.50	38	3.00	2030-1.41	■
1.42	7.10	9.50	38	3.00	2030-1.42	■
1.43	7.15	9.50	38	3.00	2030-1.43	■
1.44	7.20	9.50	38	3.00	2030-1.44	■
1.45	7.25	9.50	38	3.00	2030-1.45	■
1.46	7.30	9.50	38	3.00	2030-1.46	■
1.47	7.35	9.50	38	3.00	2030-1.47	■
1.48	7.40	9.50	38	3.00	2030-1.48	■
1.49	7.45	9.50	38	3.00	2030-1.49	■
1.50	7.50	9.50	38	3.00	2030-1.50	■
1.51	7.55	10.50	38	3.00	2030-1.51	■
1.52	7.60	10.50	38	3.00	2030-1.52	■
1.53	7.65	10.50	38	3.00	2030-1.53	■
1.54	7.70	10.50	38	3.00	2030-1.54	■
1.55	7.75	10.50	38	3.00	2030-1.55	■
1.56	7.80	10.50	38	3.00	2030-1.56	■
1.57	7.85	10.50	38	3.00	2030-1.57	■
1.58	7.90	10.50	38	3.00	2030-1.58	■
1.59	7.95	10.50	38	3.00	2030-1.59	■
1.60	8.00	10.50	38	3.00	2030-1.60	■

D1 h6	L2	L3	L1	D2 h6	Art. N°	Z
1.61	8.05	10.50	38	3.00	2030-1.61	■
1.62	8.10	10.50	38	3.00	2030-1.62	■
1.63	8.15	10.50	38	3.00	2030-1.63	■
1.64	8.20	10.50	38	3.00	2030-1.64	■
1.65	8.25	10.50	38	3.00	2030-1.65	■
1.66	8.30	10.50	38	3.00	2030-1.66	■
1.67	8.35	10.50	38	3.00	2030-1.67	■
1.68	8.40	10.50	38	3.00	2030-1.68	■
1.69	8.45	10.50	38	3.00	2030-1.69	■
1.70	8.50	10.50	38	3.00	2030-1.70	■
1.71	8.55	11.50	38	3.00	2030-1.71	■
1.72	8.60	11.50	38	3.00	2030-1.72	■
1.73	8.65	11.50	38	3.00	2030-1.73	■
1.74	8.70	11.50	38	3.00	2030-1.74	■
1.75	8.75	11.50	38	3.00	2030-1.75	■
1.76	8.80	11.50	38	3.00	2030-1.76	■
1.77	8.85	11.50	38	3.00	2030-1.77	■
1.78	8.90	11.50	38	3.00	2030-1.78	■
1.79	8.95	11.50	38	3.00	2030-1.79	■
1.80	9.00	11.50	38	3.00	2030-1.80	■
1.81	9.05	11.50	38	3.00	2030-1.81	■
1.82	9.10	11.50	38	3.00	2030-1.82	■
1.83	9.15	11.50	38	3.00	2030-1.83	■
1.84	9.20	11.50	38	3.00	2030-1.84	■
1.85	9.25	11.50	38	3.00	2030-1.85	■
1.86	9.30	11.50	38	3.00	2030-1.86	■
1.87	9.35	11.50	38	3.00	2030-1.87	■
1.88	9.40	11.50	38	3.00	2030-1.88	■
1.89	9.45	11.50	38	3.00	2030-1.89	■
1.90	9.50	11.50	38	3.00	2030-1.90	■
1.91	9.55	12.50	38	3.00	2030-1.91	■
1.92	9.60	12.50	38	3.00	2030-1.92	■
1.93	9.65	12.50	38	3.00	2030-1.93	■
1.94	9.70	12.50	38	3.00	2030-1.94	■
1.95	9.75	12.50	38	3.00	2030-1.95	■
1.96	9.80	12.50	38	3.00	2030-1.96	■
1.97	9.85	12.50	38	3.00	2030-1.97	■
1.98	9.90	12.50	38	3.00	2030-1.98	■
1.99	9.95	12.50	38	3.00	2030-1.99	■
2.00	10.00	12.50	38	3.00	2030-2.00	■
2.01	10.05	12.50	38	3.00	2030-2.01	■
2.02	10.10	12.50	38	3.00	2030-2.02	■
2.03	10.15	12.50	38	3.00	2030-2.03	■
2.04	10.20	12.50	38	3.00	2030-2.04	■
2.05	10.25	12.50	38	3.00	2030-2.05	■
2.06	10.30	12.50	38	3.00	2030-2.06	■
2.07	10.35	12.50	38	3.00	2030-2.07	■
2.08	10.40	12.50	38	3.00	2030-2.08	■
2.09	10.45	12.50	38	3.00	2030-2.09	■
2.10	10.50	12.50	38	3.00	2030-2.10	■
2.11	10.55	12.50	38	3.00	2030-2.11	■

Micro-forets

Mikrobohrer

Micro drills

Ø 2.12 - Ø 2.99 mm

2030

D1 h6	L2	L3	L1	D2 h6	Art. N°	z
2.12	10.60	12.50	38	3.00	2030-2.12	■
2.13	10.65	13.50	38	3.00	2030-2.13	■
2.14	10.70	13.50	38	3.00	2030-2.14	■
2.15	10.75	13.50	38	3.00	2030-2.15	■
2.16	10.80	13.50	38	3.00	2030-2.16	■
2.17	10.85	13.50	38	3.00	2030-2.17	■
2.18	10.90	13.50	38	3.00	2030-2.18	■
2.19	10.95	13.50	38	3.00	2030-2.19	■
2.20	11.00	13.50	38	3.00	2030-2.20	■
2.21	11.05	13.50	38	3.00	2030-2.21	■
2.22	11.10	13.50	38	3.00	2030-2.22	■
2.23	11.15	13.50	38	3.00	2030-2.23	■
2.24	11.20	13.50	38	3.00	2030-2.24	■
2.25	11.25	13.50	38	3.00	2030-2.25	■
2.26	11.30	13.50	38	3.00	2030-2.26	■
2.27	11.35	13.50	38	3.00	2030-2.27	■
2.28	11.40	13.50	38	3.00	2030-2.28	■
2.29	11.45	13.50	38	3.00	2030-2.29	■
2.30	11.50	13.50	38	3.00	2030-2.30	■
2.31	11.55	13.50	38	3.00	2030-2.31	■
2.32	11.60	13.50	38	3.00	2030-2.32	■
2.33	11.65	13.50	38	3.00	2030-2.33	■
2.34	11.70	13.50	38	3.00	2030-2.34	■
2.35	11.75	13.50	38	3.00	2030-2.35	■
2.36	11.80	13.50	38	3.00	2030-2.36	■
2.37	11.85	14.50	38	3.00	2030-2.37	■
2.38	11.90	14.50	38	3.00	2030-2.38	■
2.39	11.95	14.50	38	3.00	2030-2.39	■
2.40	12.00	14.50	38	3.00	2030-2.40	■
2.41	12.05	14.50	38	3.00	2030-2.41	■
2.42	12.10	14.50	38	3.00	2030-2.42	■
2.43	12.15	14.50	38	3.00	2030-2.43	■
2.44	12.20	14.50	38	3.00	2030-2.44	■
2.45	12.25	14.50	38	3.00	2030-2.45	■
2.46	12.30	14.50	38	3.00	2030-2.46	■
2.47	12.35	14.50	38	3.00	2030-2.47	■
2.48	12.40	14.50	38	3.00	2030-2.48	■
2.49	12.45	14.50	38	3.00	2030-2.49	■
2.50	12.50	14.50	38	3.00	2030-2.50	■
2.51	12.55	14.50	38	3.00	2030-2.51	■
2.52	12.60	14.50	38	3.00	2030-2.52	■
2.53	12.65	14.50	38	3.00	2030-2.53	■
2.54	12.70	14.50	38	3.00	2030-2.54	■
2.55	12.75	14.50	38	3.00	2030-2.55	■
2.56	12.80	14.50	38	3.00	2030-2.56	■
2.57	12.85	14.50	38	3.00	2030-2.57	■
2.58	12.90	14.50	38	3.00	2030-2.58	■
2.59	12.95	14.50	38	3.00	2030-2.59	■
2.60	13.00	14.50	38	3.00	2030-2.60	■
2.61	13.05	14.50	38	3.00	2030-2.61	■
2.62	13.10	14.50	38	3.00	2030-2.62	■

D1 h6	L2	L3	L1	D2 h6	Art. N°	z
2.63	13.15	14.50	38	3.00	2030-2.63	■
2.64	13.20	14.50	38	3.00	2030-2.64	■
2.65	13.25	14.50	38	3.00	2030-2.65	■
2.66	13.30	16.50	38	3.00	2030-2.66	■
2.67	13.35	16.50	38	3.00	2030-2.67	■
2.68	13.40	16.50	38	3.00	2030-2.68	■
2.69	13.45	16.50	38	3.00	2030-2.69	■
2.70	13.50	16.50	38	3.00	2030-2.70	■
2.71	13.55	16.55	38	3.00	2030-2.71	■
2.72	13.60	16.50	38	3.00	2030-2.72	■
2.73	13.65	16.50	38	3.00	2030-2.73	■
2.74	13.70	16.50	38	3.00	2030-2.74	■
2.75	13.75	16.50	38	3.00	2030-2.75	■
2.76	13.80	16.50	38	3.00	2030-2.76	■
2.77	13.85	16.50	38	3.00	2030-2.77	■
2.78	13.90	16.50	38	3.00	2030-2.78	■
2.79	13.95	16.50	38	3.00	2030-2.79	■
2.80	14.00	16.50	38	3.00	2030-2.80	■
2.81	14.05	16.50	38	3.00	2030-2.81	■
2.82	14.10	16.50	38	3.00	2030-2.82	■
2.83	14.15	16.50	38	3.00	2030-2.83	■
2.84	14.20	16.50	38	3.00	2030-2.84	■
2.85	14.25	16.50	38	3.00	2030-2.85	■
2.86	14.30	16.50	38	3.00	2030-2.86	■
2.87	14.35	16.50	38	3.00	2030-2.87	■
2.88	14.40	16.50	38	3.00	2030-2.88	■
2.89	14.45	16.50	38	3.00	2030-2.89	■
2.90	14.50	16.50	38	3.00	2030-2.90	■
2.91	14.55	16.50	38	3.00	2030-2.91	■
2.92	14.60	16.50	38	3.00	2030-2.92	■
2.93	14.65	16.50	38	3.00	2030-2.93	■
2.94	14.70	16.50	38	3.00	2030-2.94	■
2.95	14.75	16.50	38	3.00	2030-2.95	■
2.96	14.80	16.50	38	3.00	2030-2.96	■
2.97	14.85	16.50	38	3.00	2030-2.97	■
2.98	14.90	16.50	38	3.00	2030-2.98	■
2.99	14.95	16.50	38	3.00	2030-2.99	■

■ = disponible / verfügbar / available

Revêtement sur demande/Beschichtung auf Anfrage/Coating on request

Informations techniques et symboles

Technische Informationen und Symbole

Technical information and symbols

<p>MD VHM HM</p>	<p>Métal dur Hartmetall Hard metal</p>		<p>2 dents avec coupe centrale 2 Zähne Zentrumschnitt 2 teeth center cutting</p>
<p>120°</p>	<p>Angle Winkel Angle</p>		<p>3 dents avec coupe centrale 3 Zähne Zentrumschnitt 3 teeth center cutting</p>
<p>λ^{25°</p>	<p>Angle d'hélice Spiralwinkel Helix angle</p>		<p>4 dents avec coupe centrale 4 Zähne Zentrumschnitt 4 teeth center cutting</p>
<p>Z=2</p>	<p>Nombre de dents Anzahl der Zähne Number of teeth</p>		<p>Denture décalée Versetzte Verzahnung Alternated teeth</p>
<p>2xD1</p>	<p>Rapport longueur-diamètre Länge-Durchmesser Verhältnis Length to diameter ratio</p>		<p>Denture décalée hélice différente Versetzte Verzahnung unterschiedliche Spirale Alternated teeth different helix</p>
	<p>2 lèvres, affûtage à facettes 2 Schneiden, Facettenschärfen 2 flutes, sharpening with facets</p>		<p>Denture décalée hélice progressive Versetzte Verzahnung progressive Spirale Alternated teeth progressive helix</p>
	<p>3 lèvres, affûtage à facettes 3 Schneiden, Facettenschärfen 3 flutes, sharpening with facets</p>	<p>λ^{36° λ^{38° λ^{40°</p>	<p>Hélice différente Verschiedene Spirale Different propeller</p>
	<p>Taillage demi-lune Kanonenbohrer Spitze Gundrills tip</p>	<p>λ $35^\circ/38^\circ$</p>	<p>Hélice progressive Progressive Spirale Progressiv propeller</p>
	<p>Taillage renforcé 3/4 3/4 genuteter Fräser 3/4 straight fluted</p>		<p>Fraises hémisphériques Radiusfräser End mills with ball nose</p>
	<p>Usinage radial, diagonal et axial Radiale, diagonale und axiale Bearbeitung Radial, diagonal and axial machining</p>		<p>Usinage radial et axial Radiale und axiale Bearbeitung Radial and axial machining</p>
<p>Sharp Corner</p>	<p>Coins vifs Scharfkantige Ecken Sharp corners</p>		

Informations techniques et symboles

Technische Informationen und Symbole

Technical information and symbols

Matière/Material	N° 1	N° 2
Inox / Rostfreier Stahl / Stainless steel	TiAlN	TiCN
Acier / Stahl / Steel < 700	TiCN	TiAlN
Acier / Stahl / Steel > 700	TiAlN	TiCN
Titane / Titan / Titanium	TiAlN	DLC53
Aluminium	DLC53	TiAlN
Cuivre / Kupfer / Copper	DLC53	TiAlN
Laiton / Messing / Brass	N	DLC53
Laitons sans plomb / Bleifreier Messing / Lead-free brass	DLC53	N
Or & Argent / Gold & Silber / Gold & Silver	N	DLC53
Graphite	DLC53	N
Polymères / Polymere / Polymers	N	DLC53

Diamètre outil Werkzeughdurchmesser Tool diameter	D (mm)		
Nombre de dents Zähnezahl Number of teeth	Z		
Profondeur de coupe Schnitttiefe Cutting depth	ap (mm)		
Largeur de coupe Schnittbreite Cutting width	ae (mm)		
Vitesse de coupe Schnittgeschwindigkeit Cutting speed	(m/min)	Vc =	$\frac{D \times \pi \times n}{1000}$
Nombre de tours Umdrehungen Rotations	(U/min)	n =	$\frac{Vc \times 1000}{\pi \times D}$
Avance par dent Vorschub pro Zahn Cutting feed	(mm)	fz =	$\frac{Vf}{n \times Z}$
Vitesse d'avance Vorschubgeschwindigkeit Cutting speed	(mm/min)	Vf =	fz x Z x n
Débit d'enlèvement de copeaux Spanvolumen Removal of cutting up shaving	(mm ³ /min)	Q =	ap x ae x Vf
Avance par tour Vorschub pro Umdrehung Cutting feed per rotation	(mm/U)	f =	$\frac{Vf}{n}$

Nos propositions techniques s'appliquent à la plupart des utilisations courantes.

N'hésitez pas à nous contacter pour des conseils plus précis.

Diese technische Empfehlungen gelten für die Mehrzahl der Standardanwendungen.

Unsere Techniker beraten Sie gerne für spezifische Anliegen.

These technical propositions apply to the majority of standard usages.

Do not hesitate to contact us for more specific advices.

Nouveautés présentées dans ce catalogue
 Neuheiten dieses Kataloges
 New products introduced in this catalogue



APPLITEC

Denture extra-fine Extra feine Verzahnung Extra fine teeth					1103	Page Seite Page
D1 js12	8	10	12	15	D1 js12	
D2 H7	3	3	5	5	D2 H7	
Epaisseur Dicke Thickness E +/-0.005	$Z =$ Nombre de dents Zähnezahl Number of teeth				Epaisseur Dicke Thickness E +/-0.005	14.08
0.10	48	64	64	80	0.10	
0.11	48	64	64	80	0.11	
0.12	48	64	64	80	0.12	
0.13	48	64	64	80	0.13	
0.14	48	64	64	80	0.14	
0.15	48	64	64	80	0.15	
0.16	48	64	64	80	0.16	
0.17	48	64	64	80	0.17	
0.18	48	64	64	80	0.18	
0.19	48	64	64	80	0.19	
0.20	48	64	64	80	0.20	

Denture INOX INOX Verzahnung INOX teeth					1104	Page Seite Page
D1 js12	63	80	100	D1 js12		
D2 H7	16	22	22	D2 H7		
Epaisseur Dicke Thickness E ±0.01	$Z =$ Nombre de dents Zähnezahl Number of teeth				Epaisseur Dicke Thickness E ±0.01	MAXINOX 14.10
0.80	80	100	120	0.80		
1.00	80	100	120	1.00		



Définition du nombre de dents
Empfohlene Zähnezahl
Recommended number of teeth > **14.02**

Conseils d'utilisation
Anwendungsempfehlungen
Application recommendations > **14.03**

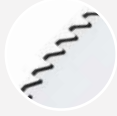
Fraises circulaires en métal dur – denture fine
VHM-Kreissägeblätter – feine Verzahnung
Solid carbide slitting saws – fine teeth
Type 1101  > **14.04**

Fraises circulaires en métal dur – denture grossière
VHM-Kreissägeblätter – grobe Verzahnung
Solid carbide slitting saws – large teeth
Type 1102  > **14.06**

Fraises circulaires en métal dur – denture extra-fine
VHM-Kreissägeblätter – extra feine Verzahnung
Solid carbide slitting saws – extra fine teeth
Type 1103  > **14.08**

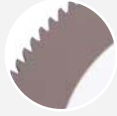
Fraises circulaires en métal dur - denture INOX
VHM-Kreissägeblätter - INOX Verzahnung
Solid carbide slitting saws - INOX teeth
Type 1104  > **14.10**

Exécutions spéciales
Sonderanfertigungen
Special executions  > **14.11**

Disques en métal dur rectifiés
Fertig geschliffene VHM-Ronden
Fully ground solid carbide discs
Type 1106  > **14.12**

Tasseaux porte-fraise avec serrage avant
Fräsdorne mit Spannung von vorne
Milling arbors with front clamping
Type 2810 / 2811 / 2815  > **14.16**

Tasseaux porte-fraise avec serrage arrière
Fräsdorne mit Spannung von hinten
Milling arbors with rear clamping
Type 2820 / 1820  > **14.17**

Définition du nombre de dents
Empfohlene Zähnezahl
Recommended number of teeth

OK

Idéalement 2-3 dents en contact
Im Idealfall 2-3 Zähne im Einsatz
Ideally 2-3 teeth in contact

KO

Trop de dents = avance trop faible par dent / pas assez de place pour le copeau
Trop peu de dents = risque de vibration / usure prématurée
Zu viele Zähne = zu geringer Vorschub pro Zahn / zu kleiner Spanraum
Zu wenig Zähne = Vibrationen / Verschleissrisiko
Too many teeth = feed too low per tooth / not enough place for the chips
Not enough teeth = vibration / risk of quick wearout

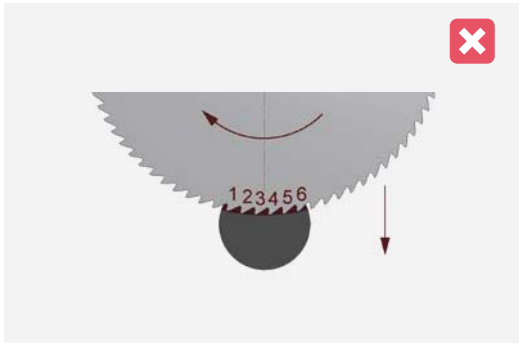
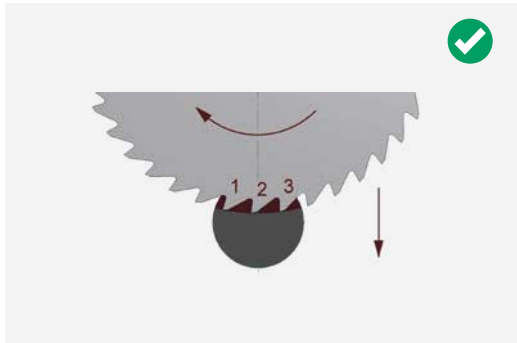
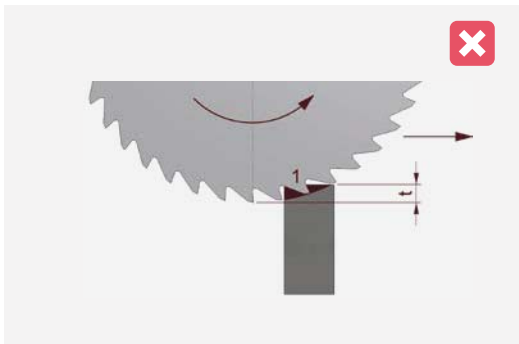
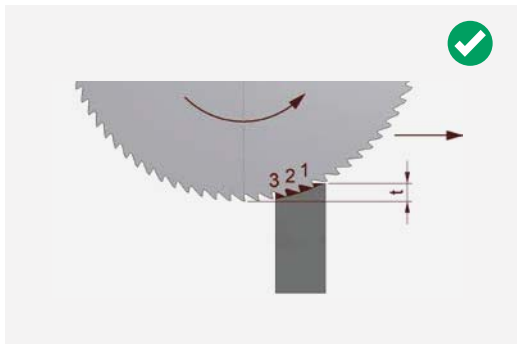
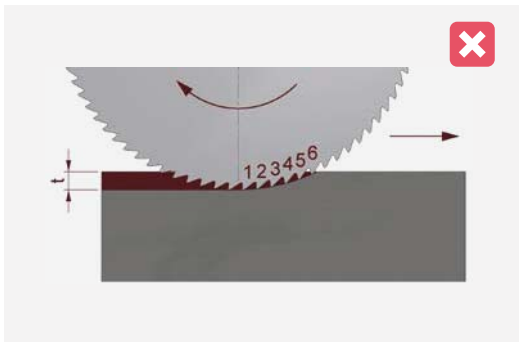
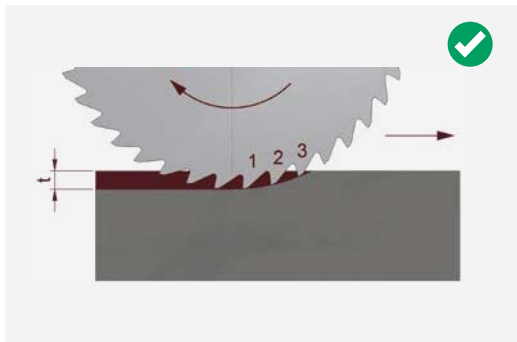

Conseils d'utilisation

Anwendungsempfehlungen

Application recommendations

		Fraises circulaires en métal dur VHM-Kreissägeblätter Solid carbide slitting saws		
Matière Werkstoff Material		Lubrifiant* Kühlung* Coolant*	VC (m/min)	Choix de la denture / avance Verzahnungswahl / Vorschub Teeth selection / cutting feed
Acier de décolletage Automatenstahl Free-cutting steel	P	O / E	120 - 240	<p>Type 1101 + 1104</p> <ul style="list-style-type: none"> • Pour usinage peu profond ou longueur à fendre faible. Avance par dent: 0.005-0.05** • Für geringe Bearbeitungstiefen oder kurze Schlitzlängen. Vorschub pro Zahn: 0.005-0.05** • For low machining depth or short slots. Feed per tooth: 0.005-0.05** <p>Type 1102</p> <ul style="list-style-type: none"> • Pour usinage profond ou grande longueur à fendre. Avance par dent: 0.01-0.1** • Für grosse Bearbeitungstiefen oder grosse Schlitzlängen. Vorschub pro Zahn: 0.01-0.1** • For deep machining or long slots. Feed per tooth: 0.01-0.1** <p>Type 1103</p> <ul style="list-style-type: none"> • Pour usinage de pièces fragiles ou fines. Avance par dent: 0.002-0.02** • Für die Bearbeitung von empfindlichen oder dünnwandigen Werkstücken. Vorschub pro Zahn: 0.002-0.02** • For machining of fragile or thin workpieces. Feed per tooth: 0.002-0.02** <p>** selon la matière, l'épaisseur ainsi que la rigidité globale ** je nach Werkstoff, Dicke und Gesamtstarrheit ** according to material, thickness and global rigidity</p>
Acier Stahl Steel < 600 N/mm ²	P	O / E	100 - 200	
Acier Stahl Steel < 800 N/mm ²	P	O / E	80 - 160	
Acier Stahl Steel < 1000 N/mm ²	P	O / E	60 - 120	
Acier Stahl Steel > 1000 N/mm ²	P	O / E	40 - 80	
Fonte Gusseisen Cast iron	K	A / E	60 - 120	
Acier inoxydable Rostfreistahl Stainless steel	M	O / E	50 - 100	
Aluminium Si < 12%	N	O / E	150 - 600	
Aluminium Si > 12%	N	O / E	80 - 300	
Cuivre, laiton, bronze Kupfer, Messing, Bronze Copper, brass, bronze	N	A / O / E	80 - 300	
Thermoplastique Thermoplaste Thermoplastics	N	A	200 - 700	
Duroplastique Duroplaste Duroplastics	N	A	150 - 600	
Acier réfractaire Warmfester Stahl Heat resistant steel	S	O / E	25 - 60	
Titane Titan Titanium	S	O / E	30 - 60	

* O = huile de coupe /Schneidöl / cutting oil

* E = Emulsion

* A = sec (air comprimé) / Trocken (Presluft) / dry (air)

avec revêtement TiN / TiCN / TiAlN, augmenter les valeurs de 20%
mit TiN / TiCN / TiAlN Beschichtung, Daten um 20% erhöhen
with TiN / TiCN / TiAlN coating, increase data by 20%

Denture fine
Feine Verzahnung
Fine teeth**DIN 1837**

- Pour usinage peu profond ou longueur à fendre faible
- Für geringe Bearbeitungstiefen oder kurze Schlitzlängen
- For low machining depth or short slots
- Avance par dent: 0.005 - 0.05 mm
- Vorschub pro Zahn: 0.005 - 0.05 mm
- Feed per tooth: 0.005 - 0.05 mm
- Revêtement sur demande
- Beschichtung auf Anfrage
- Coating on request



Fraises circulaires en métal dur

VHM-Kreissägeblätter

Solid carbide slitting saws

Type 1101

Denture fine Feine Verzahnung Fine teeth												DIN 1837
D1 js12	15	20	25	30	40	50	63	80	100	125	160	D1 js12
D2 H7	5	5	8	8	10	13	16	22	22	22	32	D2 H7
Epaisseur Dicke Thickness E ±0.01	Z = Nombre de dents Zähnezahl Number of teeth										Epaisseur Dicke Thickness E ±0.01	
0.10	64	80	80	100	128							0.10
0.15	64	80	80	100	128							0.15
0.20	64	80	80	100	128	128	160					0.20
0.25	64	64	80	100	100	128	128					0.25
0.30	64	64	80	80	100	128	128	160				0.30
0.35	64	64	64	80	100	100	128	160				0.35
0.40	64	64	64	80	100	100	128	160				0.40
0.45	48	48	64	80	80	100	128	128				0.45
0.50	48	48	64	80	80	100	128	128	160			0.50
0.60	48	48	64	64	80	100	100	128	160	160		0.60
0.70	48	48	48	64	80	80	100	128	128	160		0.70
0.80	40	40	48	64	80	80	100	128	128	160		0.80
0.90	40	40	48	64	64	80	100	100	128	160		0.90
1.00	40	40	48	64	64	80	100	100	128	160	160	1.00
1.10	40	40	48	48	64	80	80	100	128	128		1.10
1.20	40	40	48	48	64	80	80	100	128	128	160	1.20
1.30	40	40	40	48	64	64	80	100	100			1.30
1.40	40	40	40	48	64	64	80	100	100	128		1.40
1.50	40	40	40	48	64	64	80	100	100	128	160	1.50
1.60	40	40	40	48	64	64	80	100	100	128	160	1.60
1.70	40	32	40	48	48	64	80	80	100			1.70
1.80	40	32	40	48	48	64	80	80	100	128	128	1.80
1.90	40	32	40	48	48	64	80	80	100			1.90
2.00	40	32	40	48	48	64	80	80	100	128	128	2.00
2.50	40	32	40	40	48	64	64	80	100	100	128	2.50
3.00	40	32	32	40	48	48	64	80	80	100	128	3.00
3.50	24	24	32	40	40	48	64	64	80	100		3.50
4.00	24	24	32	40	40	48	64	64	80	100		4.00
5.00	24	24	32	32	40	48	48	64	80	100		5.00
6.00	24	24	24	32	40	40	48	64	64	100		6.00

**Denture grossière
Grobe Verzahnung
Large teeth****DIN 1838**

- Pour usinage profond ou grande longueur à fendre
- Für grosse Bearbeitungstiefen oder grosse Schlitzlängen
- For deep machining pr long slots
- Avance par dent: 0.01 - 0.1 mm
- Vorschub pro Zahn: 0.01 - 0.1 mm
- Feed per tooth: 0.01 - 0.1 mm
- Revêtement sur demande
- Beschichtung auf Anfrage
- Coating on request



Fraises circulaires en métal dur

VHM-Kreissägeblätter

Solid carbide slitting saws

Type 1102

Denture grossière Grobe Verzahnung Large teeth												DIN 1838
D1 js12	15	20	25	30	40	50	63	80	100	125	160	D1 js12
D2 H7	5	5	8	8	10	13	16	22	22	22	32	D2 H7
Epaisseur Dicke Thickness E ±0.01	Z = Nombre de dents Zähnezahl Number of teeth											Epaisseur Dicke Thickness E ±0.01
0.20	20	20	20	30	40							0.20
0.25	20	20	20	30	40							0.25
0.30	20	20	20	30	40							0.30
0.40	20	20	20	30	40	48	64					0.40
0.50	20	20	20	30	40	48	64					0.50
0.60	20	20	20	30	40	48	48	64	80			0.60
0.70	20	20	20	30	40	40	48	64	64			0.70
0.80	20	20	20	24	32	40	48	64	64	80		0.80
0.90	20	20	20	24	32	40	48	48	64	80		0.90
1.00	20	20	20	24	32	40	48	48	64	80	80	1.00
1.20	20	20	20	24	32	40	40	48	64	64	80	1.20
1.50	20	20	20	24	32	32	40	48	48	64	80	1.50
1.60	20	20	20	24	32	32	40	48	48	64		1.60
1.80	20	20	20	24	24	32	40	40	48	64		1.80
2.00	20	20	20	24	24	32	40	40	48	64	80	2.00
2.50	20	20	20	24	24	32	32	40	48	48	80	2.50
3.00	20	20	20	24	24	24	32	40	40	48	64	3.00
4.00	20	20	20	24	20	24	32	32	40	48		4.00
5.00	20	20	20	24	20	24	24	32	40	40		5.00
6.00	20	20	20	24	20	20	24	32	32	40		6.00

Denture extra-fine
Extra feine Verzahnung
Extra fine teeth

- Pour usinage de pièces fragiles ou fines
- Avance par dent: 0.002 - 0.03 mm
- Idéal pour le décolletage
- Revêtement sur demande
- Für die Bearbeitung von empfindlichen oder dünnwandigen Werkstücken
- Vorschub pro Zahn: 0.002 - 0.03 mm
- Für Langdrehautomaten besonders empfehlenswert
- Beschichtung auf Anfrage
- For machining of fragile or thin workpieces
- Feed per tooth: 0.002 - 0.03 mm
- Recommended on automatic lathes
- Coating on request

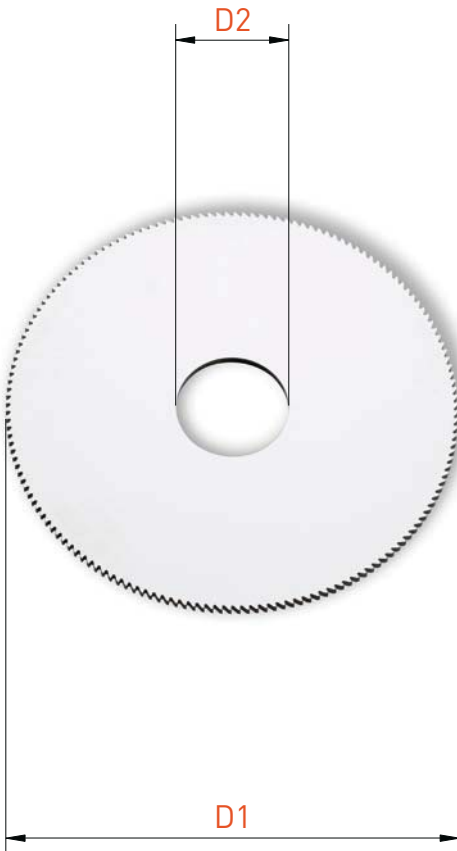

Denture extra-fine Extra feine Verzahnung Extra fine teeth					
D1 js12	8	10	12	15	D1 js12
D2 H7	3	3	5	5	D2 H7
Epaisseur Dicke Thickness E +/-0.005	$Z =$ Nombre de dents Zähnezahl Number of teeth				Epaisseur Dicke Thickness E +/-0.005
0.10	48	64	64	80	0.10
0.11	48	64	64	80	0.11
0.12	48	64	64	80	0.12
0.13	48	64	64	80	0.13
0.14	48	64	64	80	0.14
0.15	48	64	64	80	0.15
0.16	48	64	64	80	0.16
0.17	48	64	64	80	0.17
0.18	48	64	64	80	0.18
0.19	48	64	64	80	0.19
0.20	48	64	64	80	0.20

Fraises circulaires en métal dur

VHM-Kreissägeblätter

Solid carbide slitting saws

Type 1103

Denture extra-fine Extra feine Verzahnung Extra fine teeth														
D1 js12	8	10	12	15	20	20	20	25	25	25	30	32	D1 js12	
D2 H7	3	3	5	5	5	5	6	5	6	8	8	8	D2 H7	
Epaisseur Dicke Thickness E ±0.01	$Z =$ Nombre de dents Zähnezahl Number of teeth												Epaisseur Dicke Thickness E ±0.01	
0.10	**	**	**	**			100	80	80					0.10
0.15	**	**	**	**			100	80	80	100	100		80	0.15
0.20	**	**	**	**	*		100	80	80	100	100	*	80	0.20
0.25	48	64	64	80	80		100	80	80	100	100	*	80	0.25
0.30	48	64	64	80	80		100	80	80	100	100	100	80	0.30
0.35	48	64	64	80	80		100	80	80	100	100	100	80	0.35
0.40	48	64	64	80	80		100	80	80	100	100	100	80	0.40
0.50	48	64	64	80	80		100	80	80	100	100	100	80	0.50
0.60	48	64	64	80	80		100	80	80	100	100	100	80	0.60
0.70	48	64	64	80	80		100	80	80	100	100	100	80	0.70
0.80	48	64	64	80	80		100	80	80	100	100	100	80	0.80
0.90	48	64	64	80	80		100	80	80	100	100	100	80	0.90
1.00	48	64	64	80	80		100	80	80	100	100	100	80	1.00
1.20				80	80		100	80	80	100	100	100	80	1.20
1.50				80	80		100	80	80	100	100	100	80	1.50
2.00				80	80		100	80	80	100	100	100	80	2.00
2.50				80	80		100	80	80	100	100	100	80	2.50
3.00				80	80		100	80	80	100	100	100	80	3.00

D1 js12	35	40	40	40	40	45	45	50	50	63	80	D1 js12	
D2 H7	8	8	8	10	10	8	8	10	13	16	16	D2 H7	
0.10													0.10
0.15	96	100	160	100	160	100	160						0.15
0.20	96	100	160	100	160	100	160	100					0.20
0.25	96	100	160	*	160	100	160	100	120	120			0.25
0.30	96	100	160	*	160	100	160	100	120	120			0.30
0.35	96	100	160	*	160	100	160	100	120	120			0.35
0.40	96	100	160	*	160	100	160	100	120	120			0.40
0.50	96	100	160	100	160	100	160	100	120	120	128		0.50
0.60	96	100	160	100	160	100	160	100	120	120	128		0.60
0.70	96	100	160	100	160	100	160	100	120	120	128		0.70
0.80	96	100	160	100	160	100	160	100	120	120	128		0.80
0.90	96	100	160	100	160	100	160	100	120	120	128		0.90
1.00	96	100	160	100	160	100	160	100	120	120	128		1.00
1.20	96	100	160	100	160	100	160	100	120	120	128		1.20
1.50	96	100	160	100	160	100	160	100	120	120	128		1.50
2.00	96	100	160	100	160	100	160	100	120	120	128		2.00
2.50	96	100	160	100	160	100	160	100	120	120	128		2.50
3.00	96	100	160	100	160	100	160	100	120	120	128		3.00

** voir page 14.08 / siehe Seite 14.08 / see page 14.08

* voir type 1101 / siehe Typ 1101 / see type 1101

Denture fine
Feine Verzahnung
Fine teeth

DIN 1837

- Pour usinage peu profond ou longueur à fendre faible
- Für geringe Bearbeitungstiefen oder kurze Schlitzlängen
- For low machining depth or short slots
- Avance par dent: 0.005 - 0.05 mm
- Vorschub pro Zahn: 0.005 - 0.05 mm
- Feed per tooth: 0.005 - 0.05 mm
- Revêtement sur demande
- Beschichtung auf Anfrage
- Coating on request

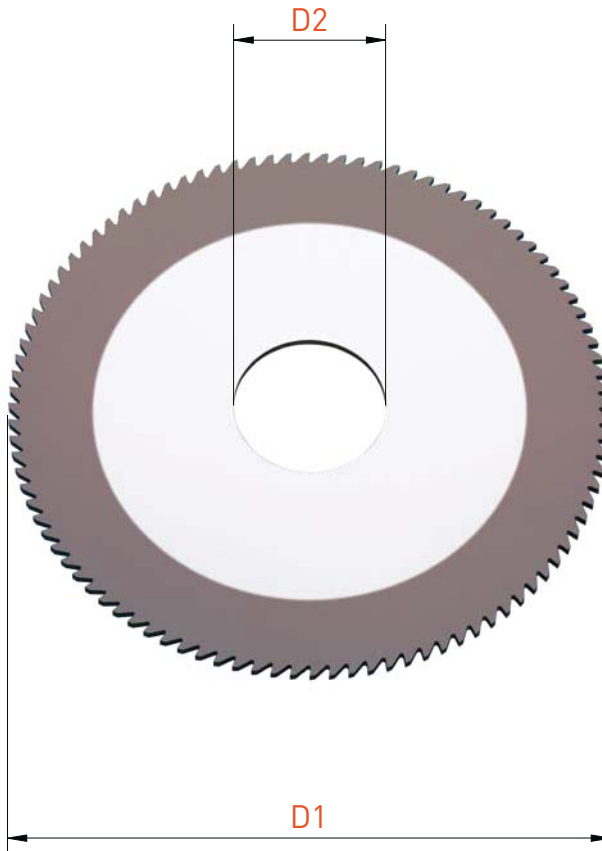

Fraises circulaires en métal dur

VHM-Kreissägeblätter

Solid carbide slitting saws

Type 1104

Denture INOX INOX Verzahnung INOX teeth				DIN 1837	
D1 js12	63	80	100	D1 js12	MAXINDEX
D2 H7	16	22	22	D2 H7	
Epaisseur Dicke Thickness E ±0.01	Z = Nombre de dents Zähnezahl Number of teeth			Epaisseur Dicke Thickness E ±0.01	
0.80	80	100	120	0.80	■
1.00	80	100	120	1.00	■

Exécutions spéciales

Sonderanfertigungen

Special executions

- Denture forme B
- Denture forme W
- Train de fraises
- Alésage avec entrée de clavette
- Autres exécutions spéciales sur demande
- Revêtement sur demande

- B Zahnform
- W Zahnform
- Spezielle Kreissägeblätter im Satz
- Bohrung mit Keilnute
- Andere Sonderanfertigungen auf Anfrage
- Beschichtung auf Anfrage

- Tooth form B
- Tooth form W
- Special slitting saws in set
- Bore with keyway
- Other special executions on request
- Coating on request

Prêt pour le taillage de la denture
Bereit zum Verzahnen
Ready for teeth grinding

- Finition poli miroir des deux faces avec dépouille
- Alésage tolérance H7
- Diamètre surdimensionné ~0.15 mm
- Hochglanz Seiten mit Hohlsliff
- H7 Bohrung Toleranz
- Aussendurchmesser mit ~0.15 mm Übermass
- Mirror finish on both sides with clearance
- Bore with H7 tolerance
- Outside diameter with ~0.15 mm oversize



Disques en métal dur rectifiés

Fertig geschliffene VHM-Ronden

Fully ground solid carbide discs

Ø 8-35 mm

Type 1106

Prêt pour le taillage de la denture Bereit zum Verzahnen Ready for teeth grinding													
D1 ~ +0.15	8	10	12	15	20	20	25	25	25	30	32	35	D1 ~ +0.15
D2 H7	3	3	5	5	5	6	5	6	8	8	8	8	D2 H7
Epaisseur Dicke Thickness E ±0.01	Epaisseurs et alésages spéciaux sur demande Andere Dicken und Bohrungen auf Anfrage Other thicknesses and bores on request											Epaisseur Dicke Thickness E ±0.01	
0.10	■	■	■	■	■	■	■	■	■	■			0.10
0.15	■	■	■	■	■	■	■	■	■	■	■	■	0.15
0.20	■	■	■	■	■	■	■	■	■	■	■	■	0.20
0.25	■	■	■	■	■	■	■	■	■	■	■	■	0.25
0.30	■	■	■	■	■	■	■	■	■	■	■	■	0.30
0.35	■	■	■	■	■	■	■	■	■	■	■	■	0.35
0.40	■	■	■	■	■	■	■	■	■	■	■	■	0.40
0.45	□	□	□	■	■	■	■	□	■	■	□	■	0.45
0.50	■	■	■	■	■	■	■	■	■	■	■	■	0.50
0.60	■	■	■	■	■	■	■	■	■	■	■	■	0.60
0.70	■	■	■	■	■	■	■	■	■	■	■	■	0.70
0.80	■	■	■	■	■	■	■	■	■	■	■	■	0.80
0.90	■	■	■	■	■	■	■	■	■	■	■	■	0.90
1.00	■	■	■	■	■	■	■	■	■	■	■	■	1.00
1.10			□	■	■	□	□	□	■	■	□	□	1.10
1.20			□	■	■	■	■	■	■	■	■	■	1.20
1.30			□	■	■	□	□	□	■	■	□	□	1.30
1.40			□	■	■	□	□	□	■	■	□	□	1.40
1.50			■	■	■	■	■	■	■	■	■	■	1.50
1.60				■	■	□	□	□	■	■	□	□	1.60
1.70				■	■	□	□	□	■	■	□	□	1.70
1.80				■	■	□	□	□	■	■	□	□	1.80
1.90				■	■	□	□	□	■	■	□	□	1.90
2.00				■	■	■	■	■	■	■	■	■	2.00
2.50				■	■	■	■	■	■	■	■	■	2.50
3.00				■	■	■	■	■	■	■	■	■	3.00
3.50				■	■				■	■			3.50
4.00				■	■				■	■			4.00
5.00				■	■				■	■			5.00
6.00				■	■				■	■			6.00

■ = disponible / verfügbar / available

□ = selon disponibilité du stock / jenach Lagerverfügbarkeit / depending on stock availability

Prêt pour le taillage de la denture
Bereit zum Verzahnen
Ready for teeth grinding

- Finition poli miroir des deux faces avec dépouille
- Alésage tolérance H7
- Diamètre surdimensionné ~0.15 mm
- Hochglanz Seiten mit Hohlsliff
- H7 Bohrung Toleranz
- Aussendurchmesser mit ~0.15 mm Übermass
- Mirror finish on both sides with clearance
- Bore with H7 tolerance
- Outside diameter with ~0.15 mm oversize



Disques en métal dur rectifiés

Fertig geschliffene VHM-Ronden

Fully ground solid carbide discs

Ø 40-160 mm

Type 1106

Prêt pour le taillage de la denture Bereit zum Verzahnen Ready for teeth grinding													
D1 ~ +0.15	40	40	45	50	50	63	80	80	100	125	160	160	D1 ~ +0.15
D2 H7	8	10	8	10	13	16	16	22	22	22	22	32	D2 H7
Epaisseur Dicke Thickness E ±0.01	Epaisseurs et alésages spéciaux sur demande Andere Dicken und Bohrungen auf Anfrage Other thicknesses and bores on request											Epaisseur Dicke Thickness E ±0.01	
0.10		■											0.10
0.15	■	■	■										0.15
0.20	■	■	■	■	■	■							0.20
0.25	■	■	■	■	■	■							0.25
0.30	■	■	■	■	■	■		■					0.30
0.35	■	■	■	■	■	■		■					0.35
0.40	■	■	■	■	■	■		■					0.40
0.45	■	■	□	□	■	■		■					0.45
0.50	■	■	■	■	■	■	■	■	■				0.50
0.60	■	■	■	■	■	■	■	■	■	■			0.60
0.70	■	■	■	■	■	■	■	■	■	■			0.70
0.80	■	■	■	■	■	■	■	■	■	■			0.80
0.90	■	■	■	■	■	■	■	■	■	■			0.90
1.00	■	■	■	■	■	■	■	■	■	■		■	1.00
1.10	□	■	□	□	■	■	□	■	■	■		□	1.10
1.20	■	■	■	■	■	■	■	■	■	■	□	■	1.20
1.30	■	■	□	□	■	■	□	■	■	□		□	1.30
1.40	■	■	□	□	■	■	□	■	■	■		□	1.40
1.50	■	■	■	■	■	■	■	■	■	■	□	■	1.50
1.60	□	■	□	□	■	■	□	■	■	■		■	1.60
1.70	□	■	□	□	■	■	□	■	■	□		□	1.70
1.80	□	■	□	□	■	■	□	■	■	■		■	1.80
1.90	□	■	□	□	■	■	□	■	■	□		□	1.90
2.00	■	■	■	■	■	■	■	■	■	■		■	2.00
2.50	■	■	■	■	■	■	■	■	■	■		■	2.50
3.00	■	■	■	■	■	■	■	■	■	■		■	3.00
3.50		■			■	■		■	■	■			3.50
4.00		■			■	■		■	■	■			4.00
5.00		■			■	■		■	■	■			5.00
6.00		■			■	■		■	■	■			6.00

■ = disponible / verfügbar / available

□ = selon disponibilité du stock / jenach Lagerverfügbarkeit / depending on stock availability

Tasseaux porte-fraise avec serrage avant
 Fräsdorne mit Spannung von vorne
 Milling arbors with front clamping

Type 2810 / 2811 / 2815

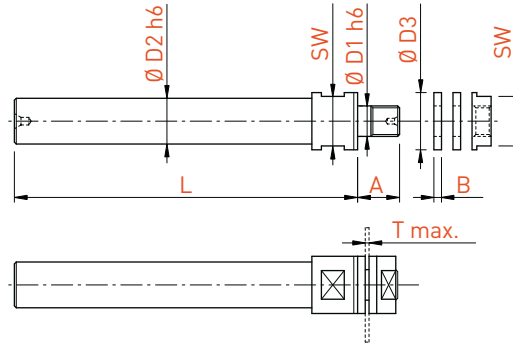

Type 2810	Rotation à droite (filet à droite) Drehrichtung rechts (Rechtsgewinde) Right hand rotation (right hand thread)							
	D1 h6	D2 h6	D3	L	A	B	SW	T max.
5.0	6.0	10.0	70	9.0	2.0	8.0	6.0	2810-5-6
5.0	10.0	10.0	80	9.0	2.0	8.0	6.0	2810-5-10
6.0	10.0	12.0	80	9.5	2.0	10.0	6.0	2810-6-10
8.0	10.0	15.0	80	10.0	2.0	13.0	6.0	2810-8-10
8.0	12.0	15.0	90	10.0	2.0	13.0	6.0	2810-8-12
10.0	6.0	18.0	80	10.5	2.0	15.0	6.0	2810-10-6
10.0	10.0	18.0	80	10.5	2.0	15.0	6.0	2810-10-10
10.0	16.0	18.0	100	10.5	2.0	15.0	6.0	2810-10-16
13.0	16.0	22.0	110	11.0	2.0	19.0	6.0	2810-13-16
16.0	20.0	26.0	120	12.0	2.0	22.0	6.0	2810-16-20
22.0	16.0	32.0	120	12.0	2.0	27.0	6.0	2810-22-16

Type 2811	Rotation à droite (filet à droite) Drehrichtung rechts (Rechtsgewinde) Right hand rotation (right hand thread)							
	D1 h6	D2 h6	D3	L	A	B	SW	T max.
16.0	10.0	22.0	80	8.0	2.0	19.0	3.0	2811-16-10

Type 2815	Pour petites fraises circulaires (filet à droite) Für kleine Kreissägeblätter (Rechtsgewinde) For small slitting saws (right hand thread)							
	D1 h6	D2 h6	D3	L	A	B	SW	T max.
3.0	5.0	5.0	60	7.0	1.0	4.0	3.0	2815-3-5
5.0	6.0	7.5	70	7.0	1.0	6.0	3.0	2815-5-6

Tasseaux porte-fraise avec serrage arrière

Fräsdorne mit Spannung von hinten

Milling arbors with rear clamping

Type 2820 / 1820

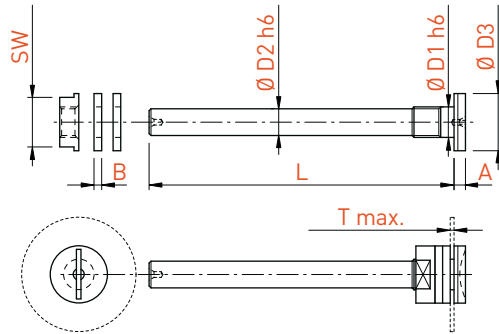

Type 2820	Rotation à droite (filet à gauche) Drehrichtung rechts (Linksgewinde) Right hand rotation (left hand thread)								
	D1 h6	D2 h6	D3	L	A	B	SW	T max.	Art. N°
	5.0	4.0	10.0	50	3.0	2.0	8.0	6.0	2820-5-4
	6.0	5.0	12.0	60	3.0	2.0	10.0	6.0	2820-6-5
	8.0	6.0	15.0	80	3.0	2.0	13.0	6.0	2820-8-6
	8.0	7.0	15.0	80	3.0	2.0	13.0	6.0	2820-8-7
	10.0	6.0	18.0	70	3.5	2.0	15.0	6.0	2820-10-6
	10.0	8.0	18.0	90	3.5	2.0	15.0	6.0	2820-10-8
	13.0	10.0	22.0	110	3.5	2.0	19.0	6.0	2820-13-10
	16.0	12.0	26.0	120	3.5	2.0	22.0	6.0	2820-16-12

Type 1820	Rotation à gauche (filet à droite) Drehrichtung links (Rechtsgewinde) Left hand rotation (right hand thread)								
	D1 h6	D2 h6	D3	L	A	B	SW	T max.	Art. N°
	5.0	4.0	10.0	50	3.0	2.0	8.0	6.0	1820-5-4
	6.0	5.0	12.0	60	3.0	2.0	10.0	6.0	1820-6-5
	8.0	6.0	15.0	70	3.0	2.0	13.0	6.0	1820-8-6
	10.0	6.0	18.0	70	3.5	2.0	15.0	6.0	1820-10-6

Chaque tasseau est livré avec 2 entretoises et 1 écrou

Jeder Fräsdorn wird mit 2 Abstandsringen und 1 Mutter geliefert

2 distance rings and 1 nut are included with each arbor

Pièces de rechange Ersatzteile Spare parts	E	Art. N°	Art. N°
	2	2810-D1*-A	2810-D1*-B
	2	2811-D1*-A	2811-D1*-B
	1	2815-D1*-A	2815-D1*-B
	2	2820-D1*-A	2820-D1*-B

* Diamètre D1 à spécifier * Durchmesser D1 angeben * Diameter D1 to be specified

INDEX

Répertoire des articles

Artikelverzeichnis

Index of items

	Art. N°	Page
10	1010	13.72
11	1101	14.04
	1102	14.06
	1103	14.08
	1104	14.10
	1106	14.12
	1107	12.19
12	1200	12.14
14	1400	12.02
	1401	12.03
	1402	12.18
	1420	12.04
	1460	12.05
15	1500	12.15
	1510	12.15
16	1600	12.16
	1610	12.17
	1680-120	13.68
	1680-90	13.67
18	1820	14.17
19	1901	13.59
20	2010	13.73
	2011	13.74
	2012	13.74
	2013	13.75
	2014	13.75
	2020	13.70
	2023	13.76
	2026	13.79
	2030	13.81
22	2200	12.14
24	2400	12.02
	2401	12.03
	2402	12.18
	2405	12.08
	2420	12.04
	2425	12.09
	2435	12.12
	2436	12.13
	2440	12.10
	2441	12.10
	2450	12.06
	2450	12.06
	2460	12.07
25	250	4.04
	251	4.08
	251-E	4.17
	252	4.10
	2520	12.15
	253	4.12
	2530	12.15
	254	4.14
	256	4.16
26	260	4.04
	261	4.08
	261-E	4.17
	262	4.10
	2620	12.16
	263	4.12
	2630	12.17

	Art. N°	Page
	264	4.14
	266	4.16
	2680-60	13.66
	2680-90	13.67
	2680-120	13.68
	2690	13.69
28	2810	14.16
	2811	14.16
	2815	14.16
	2820	14.17
31	311	6.06
	312	6.06
	313	6.06
	314	6.06
	315	6.06
	316	6.06
	317	6.08
	3170	13.05
	3170R	13.06
	318	6.08
	319	6.09
32	321	6.06
	322	6.06
	323	6.06
	3230	13.38
	3231	13.39
	3238	13.52
	324	6.06
	325	6.06
	326	6.06
	327	6.08
	3271	13.09
	3278	13.30
	328	6.08
	329	6.09
33	332	6.10
	333	6.10
	3330	13.40
	3331	13.43
	3336-HA	13.42
	3337-HA	13.42
	3338	13.53
	334	6.10
	3341	13.45
	335	6.10
	336	6.10
	3361	13.46
	337	6.12
	3371	13.15
	3375	13.24
	338	6.12
	3383	13.54
	339	6.13
34	340-JET	6.11
	342	6.10
	343	6.10
	3430	13.47
	3431	13.48
	344	6.10
	3440-S	13.50

Répertoire des articles

Artikelverzeichnis

Index of items

	Art. N°	Page
	3441	13.51
	345	6.10
	346	6.10
	347	6.12
	3471	13.25
	3472	13.28
	348	6.12
	349	6.13
38	3831	13.55
	3833	13.55
39	3901	13.59
	3911	13.58
63	630	3.06
	631-EP	3.30
	632	3.08
	633	3.11
	634	3.19
	635	3.24
	636	3.26
	637	3.28
64	640	3.06
	641-EP	3.30
	642	3.08
	643	3.11
	644	3.19
	645	3.24
	646	3.26
	647	3.28
65	650	3.31
	651	3.34
	651-EP	3.44
	651R	3.39
66	660	3.31
	661	3.34
	661-EP	3.44
	661R	3.39
70	701S3371	13.56
	7050	1.142
	7051	1.143
	7051-E	1.147
	7051R	1.145
	7060	1.142
	7061	1.143
	7061-E	1.147
	7061L	1.145
71	710	1.14/2.06
	711	1.16
	711-EP	1.23
	711-ESF	2.09
	711SF	2.08
	712	1.17
	712SF	2.08
	713	1.18
	713SF	2.09
	714	1.21
	716	1.22
72	720	1.14
	721	1.16
	721-EP	1.23
	722	1.17

	Art. N°	Page
	723	1.18
	724	1.21
	726	1.22
73	730	1.26/2.10
	730-DECO	1.158
	730R-DECO	1.156
	730R-MULTISWISS	1.162
	731	1.32
	731-E	1.67
	731-ESF	2.18
	731R	1.39
	731RSF	2.20
	732	1.45
	733	1.49
	734	1.56
	735	1.61
	736	1.63
	736SF	2.16
	737	1.66
74	740	1.26/2.10
	740-DECO	1.156
	740L-DECO	1.158
	740Z	1.155
	741	1.32
	741-E	1.67
	741-ESF	2.18
	741L	1.39
	741SF	2.12
	742	1.45
	742SF	2.12
	743	1.49
	743SF	2.14
	744	1.56
	745	1.61
	746	1.63
	746SF	2.16
	747	1.66
	748SF	2.17
	749SF	2.17
75	750	1.70
	750R-DECO	1.157
	750R-MULTISWISS	1.162
	750RAS	1.163
	751	1.78
	751-E	1.13
	751R	1.88
	752	1.10
	753	1.106
	754	1.117
	756	1.125
	757	1.128
76	760	1.70
	760L-DECO	1.159
	760Z	1.155
	761	1.78
	761-E	1.13
	761L	1.88
	762	1.10
	763	1.106
	766	1.125

INDEX

Répertoire des articles

Artikelverzeichnis

Index of items

	Art. N°	Page
	767	1.128
77	770	1.132
	770R-DECO	1.16
	771	1.135
	771-E	1.141
	771R	1.137
78	780	1.132
	781	1.135
	781-E	1.141
	781L	1.137
B	B-E	10.40
	BA	10.18
	BAX	10.20
	BCX	10.22
	BH	10.10
	BH-MASTER	10.42
	BW	10.43
C	C45	10.24
	C45X	10.26
	C3 / C4 POLYGONAL INTERFACE	1.152
	CCGT	7.16
	CCMT	7.20
	CERMET CC...	7.22
	CERMET DC...	7.36
	CERMET VC...	7.52
	CUT-GN	9.21
	CUT-H	9.10
	CUT-HX	9.11
	CUT-HZ	9.12
	CUT-PN	9.16
	CUT-PNW	9.18
	CUT-PR	9.17
	CUT-PRW	9.19
	CUT-TN	9.20
	CUT-UL	9.15
	CUT-UN	9.14
	CUT-UR	9.15
D	DCGT	7.30
	DCMT	7.34
	DHD3371	13.23
	DHP3336	13.44
	DHP3436	13.49
	DHP3471	13.27
	DT	1.164
E	E-DHP3300	13.35
	E-DHP3400	13.35
	E300-P	13.61
	E300-R	13.62
	E900-P	13.63
	ET-AN	8.18
	ET-AR	8.19
	ET-H	8.06
	ET-HK	8.08
	ET-HM	8.11
	ET-HUK	8.10
	ET-JN	8.14
	ET-JR	8.15
	ET-TN	8.16
	ET-TR	8.17
	ET-UL	8.13

	Art. N°	Page
	ET-UN	8.12
	ET-UR	8.13
F	FEG	10.38
	FIG	10.39
G	GTX	10.30
	GX	10.28
H	HSK	1.154
M	ML-AD	11.81
	ML-FIX	11.78
	ML-JET	11.78
	ML-MASTER	11.81
	ML-PRESET	11.80
	ML12-B074-1-6T	11.51
	ML12-B075-1-8T	11.52
	ML12-CITIZEN-C16	11.06
	ML12-CITIZEN-L12	11.07
	ML12-CITIZEN-R04-QTF3101-3T	11.10
	ML12-CITIZEN-R04-QTF5008-4T	11.08
	ML12-CITIZEN-R04-QTF5108-4T	11.08
	ML12-CITIZEN-R07-QTF4008-5T	11.11
	ML12-CITIZEN-R07-QTF4108-6T	11.11
	ML12-CITIZEN-R07-QTF4208-3T	11.12
	ML12-CITIZEN-R07-QTF4608-4T	11.12
	ML12-CT20-2020019-7T	11.39
	ML12-D10-3T	11.19
	ML12-DECO10-DUO	11.33
	ML12-DECO10-JET	11.33
	ML12-DT13-2020206-9T	11.38
	ML12-GT13-390223-7T	11.40
	ML12-GT13-390224-5T	11.40
	ML12-HANWHA-XD20M	11.16
	ML12-PO34-1-5T	11.53
	ML12-PO34-1-7T	11.54
	ML12-PO34-2-10T	11.54
	ML12-PO34-2-4T	11.53
	ML12-STAR-SB-12RG	11.20
	ML12-STAR-SR-10J	11.21
	ML12-STAR-SW-12R11-2T	11.22
	ML12-STAR-SW-12R11-8T	11.22
	ML12-SWISS-NANO-2T	11.36
	ML12-SWISS-NANO-3T	11.36
	ML12-SWISS-NANO-4T	11.37
	ML12-SWISS-NANO-6T	11.34
	ML12A	11.60
	ML12F	11.60
	ML16-CITIZEN-K16	11.13
	ML16-CITIZEN-L20	11.14
	ML16-CITIZEN-L20E	11.15
	ML16-DECO13-DUO	11.46
	ML16-DECO13-JET	11.46
	ML16-DECO20-DUO	11.47
	ML16-DECO20-JET	11.47
	ML16-DT26-2020206-7T	11.50
	ML16-GT26-389209-6T	11.42
	ML16-GT26-389210-5T	11.42
	ML16-GT32-389209-5T	11.44
	ML16-GT32-389210-4T	11.44
	ML16-HANWHA-SL12/16	11.17
	ML16-KMX26-DUO	11.18
	ML16-KMX26-JET	11.18

Répertoire des articles

Artikelverzeichnis

Index of items

Art. N°	Page
ML16-S20-DUO	11.48
ML16-S20-JET	11.48
ML16-STAR-SA-16	11.23
ML16-STAR-SB-16	11.24
ML16-STAR-SB-16/20RG	11.25
ML16-STAR-SB-20	11.26
ML16-STAR-SR-20J	11.28
ML16-STAR-SR-20R	11.27
ML16-STAR-SR-20RIII	11.28
ML16-STAR-SR-20RIV-2T	11.29
ML16-STAR-SR-20RIV-6T	11.29
ML16-STAR-SR-32J	11.30
ML16-STAR-SV-12/20	11.31
ML16-STAR-SW-20R-2T	11.32
ML16-STAR-SW-20R-6T	11.32
ML16-SWISS-ST26-DUO	11.49
ML16-SWISS-ST26-JET	11.49
ML16A	11.60
ML16F	11.60
S SC...	7.12
SD...	7.24
SV...	7.38
T T216	5.04
T216-EP	5.09
T216-FT	5.06
T216-GT	5.07
T216-GTX	5.08
T216-GX	5.05
TM	10.36
TP55	10.34
TP60	10.32
V VCGT	7.44
VCMT	7.50
W W750	1.148
W751-E	1.15
W760	1.148
W761-E	1.15

JET-LINE



NEW



DISCOVER JET-LINE IN A BRAND NEW BROCHURE !

**OUTILS DE HAUTES PERFORMANCES
POUR LE DÉCOLLETAGE
ET LA MICROMÉCANIQUE**

**HOCHLEISTUNGSWERKZEUGE
FÜR DREHAUTOMATEN
UND MIKROMECHANIK**

**HIGH PERFORMANCE TOOLING
FOR AUTOMATIC LATHES
AND MICROMECHANICS**



PERFORMANCE | PRECISION | RIGIDITY

SWISSMADE

**APPLITEC MOUTIER SA
2740 MOUTIER**

**+41 (0)32 494 60 20
INFO@APPLITEC-TOOLS.COM**

WWW.APPLITEC-TOOLS.COM